



Queensland

Transport Operations (Road Use Management) Act 1995

Transport Operations (Road Use Management—Road Rules) Regulation 2009

Current as at 1 January 2015

Information about this reprint

This reprint shows the legislation current as at the date on the cover and is authorised by the Parliamentary Counsel.

A new reprint of the legislation will be prepared by the Office of the Queensland Parliamentary Counsel when any change to the legislation takes effect. This change may be because a provision of the original legislation, or an amendment to it, commences or because a particular provision of the legislation expires or is repealed.

When a new reprint is prepared, this reprint will become a historical reprint. Also, if it is necessary to replace this reprint before a new reprint is prepared, for example, to include amendments with a retrospective commencement, an appropriate note would be included on the cover of the replacement reprint and on the copy of this reprint at www.legislation.qld.gov.au.

The endnotes to this reprint contain detailed information about the legislation and reprint. For example—

- The table of reprints endnote lists any previous reprints and, for this reprint, gives details of any discretionary editorial powers under the *Reprints Act 1992* used by the Office of the Queensland Parliamentary Counsel in preparing it.
- The list of legislation endnote gives historical information about the original legislation and the legislation which amended it. It also gives details of uncommenced amendments to this legislation. For information about possible amendments to the legislation by Bills introduced in Parliament, see the Queensland Legislation Current Annotations at www.legislation.qld.gov.au/Leg_Info/information.htm.
- The list of annotations endnote gives historical information at section level.

All Queensland reprints are dated and authorised by the Parliamentary Counsel. The previous numbering system and distinctions between printed and electronic reprints are not continued.



Queensland

Transport Operations (Road Use Management—Road Rules) Regulation 2009

Contents

		Page
Part 1	Introductory	
Division 1	General	
1	Short title	17
2	Commencement	17
3	Object	17
Division 2	Some features of this regulation	
4	Definitions	18
5	Compliance with standards	18
6	Examples	18
7	Sections 7–10 not used	19
Part 2	Application of this regulation	
Division 1	Roads and road-related areas	
11	Regulation applies to vehicles and road users on roads and road-related areas	19
12	Section number not used	20
13	What is a road-related area	20
Division 2	Road users and vehicles	
14	Road users	21
15	What is a vehicle	21
15A	Personal mobility devices	21
16	Who is a driver	22
17	Who is a rider	22
18	Pedestrian includes personal mobility device user	22
19	Reference to driver includes rider etc.	22

Contents

Part 3	Speed limits	
20	Obedying the speed limit	23
21	Speed limit where a speed limit sign applies	23
22	Speed limit in a speed limited area	24
23	Speed limit in a school zone	25
24	Speed limit in a shared zone	26
24A	Speed limit for certain vehicles	27
25	Speed limit elsewhere	28
Part 4	Making turns	
Division 1	Left turns	
26	Application of division to roundabouts, road-related areas and adjacent land	28
27	Starting a left turn from a road (except a multi-lane road)	28
28	Starting a left turn from a multi-lane road	29
29	Making a left turn as indicated by a turn line	32
Division 2	Right turns	
30	Application of division to certain right turns	34
31	Starting a right turn from a road (except a multi-lane road)	34
32	Starting a right turn from a multi-lane road	36
33	Making a right turn	38
Division 3	Hook turns at intersections	
34	Making a hook turn at a hook turn only sign	39
35	Optional hook turn by a bicycle rider	41
36	Bicycle rider making a hook turn contrary to no hook turn by bicycles sign	43
Division 4	U-turns	
37	Beginning a U-turn	44
38	Giving way when making a U-turn	44
39	Making a U-turn contrary to a no U-turn sign	44
40	Making a U-turn at an intersection with traffic lights	45
41	Making a U-turn at an intersection without traffic lights	46
42	Starting a U-turn at an intersection	46
43	Section number not used	47
Part 5	Change of direction and stop signals	
Division 1	Change of direction signals	
44	Division does not apply to entering or leaving a roundabout	47

45	What is changing direction	47
46	Giving a left change of direction signal.	49
47	How to give a left change of direction signal	50
48	Giving a right change of direction signal	50
49	How to give a right change of direction signal	51
50	How to give a right change of direction signal by giving a hand signal	51
51	When use of direction indicator lights permitted.	52
Division 2	Stop signals	
52	Division does not apply to bicycle riders or certain tram drivers .	52
53	Giving a stop signal	53
54	How to give a stop signal	53
55	How to give a stop signal by giving a hand signal	53
Part 6	Traffic lights, traffic arrows and twin red lights	
Division 1	Obeying traffic lights and traffic arrows	
56	Stopping on a red traffic light or arrow	54
57	Stopping for a yellow traffic light or arrow.	57
58	Exceptions to stopping for a red or yellow traffic light.	58
59	Proceeding through a red traffic light	59
60	Proceeding through a red traffic arrow	59
60A	Proceeding through a bicycle storage area before a red traffic light or arrow	60
61	Proceeding when traffic lights or arrows at an intersection change to red or yellow	60
Division 2	Giving way at traffic lights and traffic arrows	
62	Giving way when turning at intersection with traffic lights	61
63	Giving way at an intersection with traffic lights not operating or only partly operating.	63
64	Giving way at a flashing yellow traffic arrow at an intersection. . .	64
65	Giving way at a marked foot crossing (except at an intersection) with a flashing yellow traffic light.	65
Division 3	Twin red lights (except at level crossings)	
66	Stopping for twin red lights (except at level crossings).	65
Part 7	Giving way	
Division 1	Giving way at a stop sign, stop line, give way sign or give way line applying to the driver	
67	Stopping and giving way at a stop sign or stop line at an intersection without traffic lights.	66
68	Stopping and giving way at a stop sign or stop line at other places	69

Contents

69	Giving way at a give way sign or give way line at an intersection, other than a roundabout	70
69A	Two or more drivers facing various signs or lines at an intersection	73
70	Giving way at a give way sign at a bridge or length of narrow road	73
71	Giving way at a give way sign or give way line at other places. . .	74
Division 2	Giving way at an intersection without traffic lights or a stop sign, stop line, give way sign or give way line	
72	Giving way at an intersection (except a T-intersection or roundabout)	75
73	Giving way at a T-intersection.	80
Division 3	Entering or leaving road-related areas and adjacent land	
74	Giving way when entering a road from a road-related area or adjacent land.	85
75	Giving way when entering a road-related area or adjacent land from a road	86
Division 4	Keeping clear of and giving way to particular vehicles	
76	Keeping clear of trams travelling in tram lanes etc.	87
77	Giving way to buses	88
78	Keeping clear of police and emergency vehicles	89
79	Giving way to police and emergency vehicles	89
79A	Giving way to escorted vehicles	90
Division 5	Crossings and shared zones	
80	Stopping at a children’s crossing	90
81	Giving way at a pedestrian crossing.	93
82	Overtaking or passing a vehicle at a children’s crossing or pedestrian crossing	95
83	Giving way to pedestrians in a shared zone.	96
Division 6	Other give way rules	
84	Giving way when driving through a break in a dividing strip.	96
85	Giving way on a painted island.	98
86	Giving way in median turning bays.	99
87	Giving way when moving from a side of a road or a median strip parking area	100
Part 8	Traffic signs and road markings	
Division 1	Traffic signs and road markings at intersections and other places	
88	Left turn signs.	101
89	Right turn signs	102
90	No turns signs	102

91	No left turn and no right turn signs	103
92	Traffic lane arrows	104
Division 2	Traffic signs and road markings generally	
93	No overtaking or passing signs	105
94	No overtaking on bridge signs	106
95	Emergency stopping lane only signs	107
96	Keep clear markings.	108
97	Road access signs	109
98	One-way signs	110
99	Keep left and keep right signs	111
100	No entry signs	112
101	Hand-held stop signs	112
101A	Safety ramp and arrester bed signs	113
Division 3	Signs for trucks, buses and other large vehicles	
102	Clearance and low clearance signs	114
103	Load limit signs.	114
104	No trucks signs	115
105	Trucks must enter signs	117
106	No buses signs	117
107	Buses must enter signs	118
108	Trucks and buses low gear signs	119
Part 9	Roundabouts	
109	What is a roundabout	120
110	Meaning of halfway around a roundabout	120
111	Entering a roundabout from a multi-lane road or a road with 2 or more lines of traffic travelling in the same direction.	120
112	Giving a left change of direction signal when entering a roundabout	126
113	Giving a right change of direction signal when entering a roundabout	126
114	Giving way when entering or driving in a roundabout	127
115	Driving in a roundabout to the left of the central traffic island . . .	127
116	Obedying traffic lane arrows when driving in or leaving a roundabout	128
117	Giving a change of direction signal when changing marked lanes or lines of traffic in a roundabout	128
118	Giving a left change of direction signal when leaving a roundabout	129
119	Giving way by the rider of a bicycle or animal to a vehicle leaving a roundabout	129

Contents

Part 10	Level crossings	
120	What is a level crossing	129
121	Stopping and giving way at a stop sign at a level crossing.	130
122	Giving way at a give way sign or give way line at a level crossing	131
123	Entering a level crossing when a train or tram is approaching etc.	131
124	Leaving a level crossing	132
Part 11	Keeping left, overtaking and other driving rules	
Division 1	General	
125	Unreasonably obstructing drivers or pedestrians	132
126	Keeping a safe distance behind vehicles	133
127	Keeping a minimum distance between long vehicles	133
128	Entering blocked intersections	134
128A	Entering particular blocked crossings.	134
Division 2	Keeping to the left	
129	Keeping to the far left side of a road.	134
130	Keeping to the left on a multi-lane road	135
131	Keeping to the left of oncoming vehicles	137
132	Keeping to the left of the centre of a road or the dividing line . . .	138
133	Exceptions to keeping to the left of the centre of a road	142
134	Exceptions to keeping to the left of a dividing line	143
135	Keeping to the left of a median strip.	146
136	Driving on a one-way service road.	147
137	Keeping off a dividing strip	147
138	Keeping off a painted island.	148
139	Exceptions for avoiding obstructions on a road	150
139A	Exceptions for passing bicycle rider.	151
Division 3	Overtaking	
140	No overtaking unless safe to do so	152
141	No overtaking etc. to the left of a vehicle	152
142	No overtaking to the right of a vehicle turning right etc.	153
143	Passing or overtaking a vehicle displaying a do not overtake turning vehicle sign.	154
144	Keeping a safe distance when overtaking	155
144A	Keeping a safe lateral distance when passing bicycle rider.	155
145	Driver being overtaken not to increase speed	156

Division 4	Driving in marked lanes or lines of traffic	
146	Driving within a single marked lane or line of traffic	157
147	Moving from 1 marked lane to another marked lane across a continuous line separating the lanes	158
148	Giving way when moving from 1 marked lane or line of traffic to another marked lane or line of traffic	159
148A	Giving way when moving within a single marked lane	160
149	Giving way when lines of traffic merge into a single line of traffic	161
150	Driving on or across a continuous white edge line	161
151	Riding a motorbike or bicycle alongside more than 1 other rider .	162
Division 5	Obeying overhead lane control devices applying to marked lanes	
152	Complying with overhead lane control devices	163
Division 6	Driving in marked lanes designated for special purposes	
153	Bicycle lanes	165
154	Bus lanes	166
155	Tram lanes	167
155A	Tramways	169
156	Transit lanes	170
157	Truck lanes	171
158	Exceptions to driving in special purpose lanes etc.	172
159	Marked lanes required to be used by particular kinds of vehicles	173
Division 7	Passing trams and safety zones	
160	Passing or overtaking a tram that is not at or near the left side of the road	175
161	Passing or overtaking a tram at or near the left side of a road. . .	175
162	Driving past a safety zone	176
163	Driving past the rear of a stopped tram at a tram stop	176
164	Stopping beside a stopped tram at a tram stop	177
164AA	Staying stopped if a tram comes from behind a stopped driver and stops	178
Part 12	Restrictions on stopping and parking	
Division 1	General	
164A	Minor traffic offences	179
165	Stopping in an emergency etc. or to comply with another provision	179
166	Application of part to bicycles.	180

Contents

Division 2	No stopping and parking signs and road markings	
167	No stopping signs	180
168	No parking signs	181
169	No stopping on a road with a yellow edge line	182
Division 3	Stopping at intersections and crossings	
170	Stopping in or near an intersection	182
171	Stopping on or near a children’s crossing	184
172	Stopping on or near a pedestrian crossing (except at an intersection) 185	
173	Stopping on or near a marked foot crossing (except at an intersection) 186	
174	Stopping on or near a bicycle crossing (except at an intersection)	187
175	Stopping on or near a level crossing	188
Division 4	Stopping on clearways and freeways and in emergency stopping lanes	
176	Stopping on a clearway	189
177	Stopping on a freeway	190
178	Stopping in an emergency stopping lane	191
Division 5	Stopping in zones for particular vehicles	
179	Stopping in a loading zone	191
180	Stopping in a truck zone	193
181	Stopping in a works zone	193
182	Stopping in a taxi zone	194
183	Stopping in a bus zone	195
184	Section number not used	195
185	Stopping in a permit zone	195
186	Stopping in a mail zone	196
Division 6	Other places where stopping is restricted	
187	Stopping in a bus lane, tram lane, tramway, transit lane, truck lane or on tram tracks	197
188	Stopping in a shared zone	197
189	Double parking	198
190	Stopping in or near a safety zone	199
191	Stopping near an obstruction	200
192	Stopping on a bridge or in a tunnel etc.	200
193	Stopping on a crest or curve outside a built-up area	201
194	Stopping near a fire hydrant etc.	202

195	Stopping at or near a bus stop	203
196	Stopping at or near a tram stop	204
197	Stopping on a path, dividing strip, nature strip, painted island or traffic island	204
198	Obstructing access to and from a footpath, driveway etc.	205
199	Stopping near a postbox.	206
200	Stopping on roads—heavy and long vehicles	207
201	Stopping on a road with bicycle parking sign	207
202	Stopping on a road with motorbike parking sign	208
203	Stopping in a parking area for people with disabilities	208
203A	Stopping in a slip lane	210
Division 7	Permissive parking signs and parking fees	
204	Meaning of particular information on or with permissive parking signs 210	
205	Parking for longer than indicated	213
205A	Parking outside times indicated	214
206	Time extension for people with disabilities	214
207	Section number not used	215
Division 8	Parallel parking	
208	Parallel parking on a road (except in a median strip parking area)	215
208A	Parallel parking in a road-related area (except in a median strip parking area).	217
209	Parallel parking in a median strip parking area	218
Division 9	Angle parking	
210	Angle parking	218
Division 10	Other parking related rules	
211	Parking in parking bays	224
212	Entering and leaving a median strip parking area	225
213	Making a motor vehicle secure.	226
213A	Evidentiary provision	227
Part 13	Lights and warning devices	
Division 1	Lights on vehicles (except bicycles, animals and animal-drawn vehicles)	
214	Division does not apply to riders of bicycles, animals or animal-drawn vehicles.	228
215	Using lights when driving at night or in hazardous weather conditions 228	
216	Towing a vehicle at night or in hazardous weather conditions . . .	229

Contents

217	Using fog lights	230
218	Using headlights on high-beam	231
219	Lights not to be used to dazzle other road users	232
220	Using lights on vehicles that are stopped	232
221	Using hazard warning lights	233
222	School bus not to be driven without warning lights and warning signs 233	
222A	Use of warning lights—picking up or setting down school children	233
Division 2	Lights on animal-drawn vehicles	
223	Using lights when riding an animal-drawn vehicle at night or in hazardous weather conditions	235
Division 3	Horns and radar detectors	
224	Using horns and similar warning devices	235
225	Using radar detectors and similar devices	236
Division 4	Portable warning triangles for heavy vehicles	
226	Heavy vehicles to be equipped with portable warning triangles . .	236
227	Using portable warning triangles	236
Division 5	Signs for oversize vehicles	
227A	Do not overtake turning vehicle signs for long vehicles	238
227B	Warning sign not to be displayed if not required by law	238
Part 14	Rules for pedestrians	
Division 1	General	
228	No pedestrian signs	239
229	Pedestrians on a road with a road access sign	239
230	Crossing a road—general	240
231	Crossing a road at pedestrian lights	240
232	Crossing a road at traffic lights	242
233	Crossing a road to or from a tram	243
234	Crossing a road on or near a crossing for pedestrians	243
235	Crossing a level crossing	244
235A	Crossing a pedestrian level crossing that has a red pedestrian light	246
236	Pedestrians not to cause a traffic hazard or obstruction	246
237	Getting on or into a moving vehicle	247
238	Pedestrians travelling along a road (except if using a wheeled recreational device, wheeled toy or personal mobility device) . . .	248
239	Pedestrians on a bicycle path or separated footpath	249

Division 2	Rules for persons travelling in or on wheeled recreational devices and wheeled toys	
240	Wheeled recreational devices and toys not to be used on certain roads 252	
240A	No wheeled recreational devices or toys sign	252
241	Travelling in or on a wheeled recreational device or toy on a road	253
242	Travelling in or on a wheeled recreational device or toy on a footpath or shared path	253
243	Travelling on rollerblades etc. on a bicycle path or separated footpath 255	
244	Wheeled recreational devices or wheeled toys being towed etc. .	256
244A	Section number not used	256
244B	Wearing of helmets by users of motorised scooters.	256
Division 3	Additional rules for using personal mobility devices	
244C	Application of pt 14, div 3	257
244D	Age restrictions for PMD user	257
244E	Speed limit for device	257
244F	PMD user to wear helmet.	258
244G	PMD user travelling along a road	258
244H	No personal mobility devices sign	259
244I	Using a device on a footpath or shared path	259
244J	Carrying people on device	259
244K	Travelling to the left of oncoming PMD users or riders on a path .	260
244L	Warning equipment on device	260
244M	Using device at night	260
244N	Bicycle crossing lights provisions also apply to PMD user.	260
244O	Using mobile phones on device	261
244P	Drinking liquor while using device	261
Part 15	Additional rules for bicycle riders	
245	Riding a bicycle	261
246	Carrying people on a bicycle	262
247B	Giving way while entering or in a bicycle storage area.	262
248	Riding across a road on particular crossings	263
249	Riding on a separated footpath	264
250	Riding on a footpath or shared path.	264
251	Riding to the left of oncoming bicycle riders or device users on a path 264	

Contents

252	No bicycles signs and markings	265
253	Bicycle riders not to cause a traffic hazard.	266
254	Bicycles being towed etc.	266
255	Riding too close to the rear of a motor vehicle	267
256	Bicycle helmets	267
257	Riding with a person on a bicycle trailer.	268
258	Equipment on a bicycle	269
259	Riding at night	269
260	Stopping for a red bicycle crossing light.	269
261	Stopping for a yellow bicycle crossing light	270
262	Proceeding when bicycle crossing lights change to yellow or red	271
Part 16	Rules for persons travelling in or on vehicles	
263	Application of part to persons in or on trams	272
264	Wearing of seatbelts by drivers	272
265	Wearing of seatbelts by passengers 16 years old or older.	272
266	Wearing of seatbelts by passengers under 16 years old	274
267	Exemptions from wearing seatbelts	278
268	How persons must travel in or on a motor vehicle	281
269	Opening doors and getting out of a vehicle etc.	283
270	Wearing motorbike helmets	283
271	Riding on motorbikes	284
272	Interfering with the driver's control of the vehicle etc.	285
Part 17	Additional rules for drivers of trams, tram recovery vehicles and buses	
Division 1	Trams	
273	Division also applies to tram recovery vehicles and buses travelling along tram tracks	286
274	Stopping for a red T light	286
275	Stopping for a yellow T light	286
276	Exception to stopping for a red or yellow T light.	287
277	Proceeding after stopping for a red or yellow T light	287
278	Proceeding when a red traffic light and a white T light or white traffic arrow is showing.	287
279	Proceeding when a white T light or white traffic arrow is no longer showing	288
Division 2	Buses, taxis and bicycles	
280	Application of division.	289

281	Stopping for a red B light	289
282	Stopping for a yellow B light	290
283	Exception to stopping for a red or yellow B light.	290
284	Proceeding after stopping for a red or yellow B light	290
285	Proceeding when a red traffic light and a white B light or white traffic arrow is showing.	291
286	Proceeding when a white B light or white traffic arrow is no longer showing	291
Part 18	Miscellaneous road rules	
Division 1	Miscellaneous rules for drivers	
287	Duties of a driver involved in a crash	292
288	Driving on a path	294
289	Driving on a nature strip	295
290	Driving on a traffic island	295
291	Making unnecessary noise or smoke	296
292	Section number not used	297
293	Removing fallen etc. things from the road	297
293A	Oil and grease	297
293B	Restriction on driving or stopping vehicle on road	298
294	Keeping control of a vehicle being towed	298
295	Motor vehicle towing another vehicle with a towline.	299
296	Driving a vehicle in reverse	300
297	Driver to have proper control of a vehicle etc.	300
298	Driving with a person in a trailer	301
299	Television receivers and visual display units in motor vehicles	301
300	Use of mobile phones.	302
300A	Drinking liquor while driving	302
300C	Limitation on use of wheeled recreational device or wheeled toy	303
300D	Driver must not damage rail infrastructure or obstruct level crossing	303
Division 2	Rules for people in charge of animals	
301	Leading an animal while in or on a vehicle.	304
301A	Harnessing an animal drawing a vehicle	305
301B	Riding an animal on a road-related area when possible	305
302	Rider of an animal on a footpath or nature strip to give way to pedestrians.	305
303	Riding an animal alongside more than 1 other rider.	305
303A	Giving way to restive horses.	306

Contents

Division 2A	Rules for people in charge of animal-drawn vehicles	
303B	Brakes	306
Division 3	Obeying directions	
304	Direction by police officer or traffic controller	307
Part 19	Exemptions	
305	Exemption for drivers of police vehicles	307
306	Exemptions for drivers of emergency vehicles	308
307	Stopping and parking exemption for police and emergency vehicles	308
308	Exemption for police officers and emergency workers on foot . . .	309
308A	Exemption for police officers using personal mobility devices . . .	309
309	Exemptions for drivers of trams etc.	309
310	Exemption for road workers etc.	310
311	Exemption for oversize vehicles	312
312	Exemption for tow truck drivers	313
313	Exemption for postal vehicles.	314
313A	Exemption for garbage truck drivers etc.	315
313B	Exemption for breakdown vehicles.	316
Part 20	Traffic control devices and traffic-related items	
Division 1	General	
314	Diagrams of traffic control devices, traffic-related items and symbols	317
315	Legal effect of traffic control devices	318
316	When do traffic control devices comply substantially with this regulation	318
317	Information on or with traffic control devices	321
318	Limited effect of certain traffic control devices	322
319	Legal effect of traffic-related items mentioned in this regulation .	323
320	When do traffic-related items comply substantially with this regulation	323
321	Meaning of information on or with traffic control devices and traffic-related items.	324
322	Reference to traffic control devices and traffic-related items on a road etc.	324
323	References to lights that are traffic signals.	326
323A	Audible lines.	326
Division 2	Application of traffic control devices to lengths of roads and areas	
324	Purpose of division.	327

325	References to traffic control devices—application to lengths of road and areas	327
326	When do traffic control devices apply to a length of road or area—the basic rules	327
327	Length of road to which a traffic sign (except a parking control sign) applies	328
328	References to a traffic control device applying to a length of road	328
329	Traffic control devices applying to a marked lane.	328
330	Traffic control devices applying to a slip lane	329
331	Traffic control devices applying to an intersection	329
332	Parking control signs applying to a length of road	330
333	Parking control signs applying to a length of road in an area to which another parking control sign applies etc.	330
334	How parking control signs apply to a length of road.	331
335	Traffic control devices applying to an area	332
336	How separated footpath signs and separated footpath road markings apply.	334
Division 3	Application of traffic control devices to persons	
337	Purpose of division.	335
338	References to traffic control devices—application to persons . . .	335
339	When do traffic control devices apply to a person—the basic rules	335
340	Traffic control devices (except road markings and parking control signs)	336
341	Road markings	336
342	Traffic signs (except parking control signs) applying to a length of road	337
343	Traffic signs (except parking control signs) applying to an area . .	337
344	Traffic control devices applying to a driver in a marked lane	338
345	Traffic control devices applying to a driver in a slip lane.	338
346	Parking control signs	338
Part 21	General	
347	Meaning of abbreviations and symbols	339
348	References to a driver doing something etc.	339
349	References to certain kinds of roads	339
350	References to stopping or parking on a length of road etc.	339
351	References to left and right	340
352	References to stopping as near as practicable to a place	340
352A	Giving way to pedestrians crossing a road.	340

Contents

353	Prescribed offences for ch 5, pt 7 of the Act	341
353AA	Prescribed offences for the Act, s 113A(2)(a) and (b)	341
353A	People with disabilities symbols—Act, sch 4, definition people with disabilities symbol	342
353B	Power-assisted bicycles—Act, sch 4, definition power-assisted bicycle 342	
Part 22	Repeal and transitional provisions	
354	Repeal	343
355	Continuation of Transport Operations (Road Use Management—Road Rules) Regulation 1999, s 266	343
356	References to Transport Operations (Road Use Management—Road Rules) Regulation 1999	343
Schedule 1	Abbreviations and symbols	344
Schedule 2	Standard or commonly used traffic signs	345
Schedule 3	Other permitted traffic signs	365
Schedule 4	Symbols and traffic-related items	389
Schedule 5	Dictionary	392
 Endnotes		
1	Index to endnotes	410
2	Key	410
3	Table of reprints	411
4	List of legislation	412
5	List of annotations	414

Transport Operations (Road Use Management—Road Rules) Regulation 2009

[as amended by all amendments that commenced on or before 1 January 2015]

Part 1 Introductory

Division 1 General

1 Short title

This regulation may be cited as the *Transport Operations (Road Use Management—Road Rules) Regulation 2009* or as the Queensland Road Rules.

2 Commencement

- (1) This regulation, other than sections 266 and 267(1), (1AA), (1AB), (1A), (1B) and (1C), commences on 12 October 2009.
- (2) Sections 266 and 267(1), (1AA), (1AB), (1A), (1B) and (1C) commence on 11 March 2010.

3 Object

The object of this regulation is to provide road rules in Queensland that are substantially uniform with road rules elsewhere in Australia.

[s 4]

Division 2 Some features of this regulation

4 Definitions

The dictionary in schedule 5 defines particular words used in this regulation.

5 Compliance with standards

(1) In this regulation, unless otherwise stated—

- (a) a reference to a standard using the designation made up of ‘AS’ and a number is a reference to the standard as in force from time to time under that designation; and

Example—

‘AS 1754’ is a reference to the standard that is in force under that designation at the relevant time, including, for example, AS 1754–1991.

- (b) a reference to a standard using the designation made up of ‘AS/NZS’ and a number is a reference to the standard as in force from time to time under that designation.

Example—

‘AS/NZS 1754’ is a reference to the standard that is in force under that designation at the relevant time, including, for example, AS/NZS 1754–1995, AS/NZS 1754–2000 or AS/NZS 1754–2004.

- (2) If this regulation requires a person to fit or use a thing that complies with a standard mentioned in subsection (1), the person complies with the requirement if, when the thing was manufactured, the thing complied with the standard in force under the designation at that time.

(3) In this section—

standard means AS or AS/NZS.

6 Examples

A diagram under a provision is an example for the provision.

7 Sections 7–10 not used

Note—

This regulation is based on the Australian Road Rules. Some provisions of the Australian Road Rules contain provisions that are not relevant to the operation of this regulation. To maximise uniformity between this regulation and the Australian Road Rules, the numbers of some sections that are not relevant have not been used in the numbering of this regulation, unless required for provisions particular to the State.

Part 2 Application of this regulation

Division 1 Roads and road-related areas

11 Regulation applies to vehicles and road users on roads and road-related areas

- (1) This regulation applies to vehicles and road users on roads and road-related areas.
- (2) A reference in this regulation (except in this division) to a **road** includes a reference to a **road-related area**, unless otherwise expressly stated in this regulation.

Examples for subsection (2)—

- 1 A reference in section 146 (which deals with driving within a single marked lane or line of traffic) to the road includes a reference to the road-related area of the road.
- 2 A reference in section 200(1) (which deals with certain heavy or long vehicles stopping on roads) to a length of road includes a reference to the road-related area of the length of road.
- 3 A reference in section 31 (which deals with starting a right turn from a road, except a multi-lane road) to a road does not include a reference to a road-related area, because of the definition in subsection (5) of that section.

[s 12]

12 Section number not used

13 What is a *road-related area*

- (1) A *road-related area* is any of the following—
 - (a) an area that divides a road;
 - (b) a footpath or nature strip adjacent to a road;
 - (c) an area that is not a road and that is open to the public and designated for use by cyclists or animals;
 - (d) an area that is not a road and that is open to, or used by, the public for parking vehicles.
- (2) However, unless the contrary intention appears, a reference in this regulation (except this division) to a *road-related area* includes a reference to—
 - (a) any shoulder of a road; and
 - (b) any other area that is a footpath or nature strip as defined in the dictionary.
- (3) In this section—

shoulder, of a road—

 - (a) includes any part of the road that is not designed to be used by motor vehicles in travelling along the road; and
 - (b) includes—
 - (i) for a kerbed road—any part of the kerb; and
 - (ii) for a sealed road—any unsealed part of the road, and any sealed part of the road outside an edge line on the road; but
 - (c) does not include a bicycle path, footpath or shared path.

Division 2 Road users and vehicles

14 Road users

A *road user* is a driver, rider, passenger or pedestrian.

15 What is a *vehicle*

A *vehicle* includes—

- (a) a motor vehicle, trailer and tram; and
- (b) a bicycle; and
- (c) an animal-drawn vehicle, and an animal that is being ridden or drawing a vehicle; and
- (d) a combination; and
- (e) a motorised wheelchair that can travel at over 10km/h (on level ground);

but does not include another kind of wheelchair, a train, a wheeled recreational device, a wheeled toy or a personal mobility device.

15A Personal mobility devices

- (1) This section applies for the purposes of the Act, schedule 4, definition *personal mobility device*, paragraph (b).
- (2) A vehicle is prescribed to be a personal mobility device if the vehicle—
 - (a) is designed to be self-balancing while a person is using the vehicle; and
 - (b) has 2 wheels that operate on a single axis; and
 - (c) is propelled by an electric motor; and
 - (d) can not reach a speed of more than 20km/h; and
 - (e) has a control that can limit the vehicle's speed to 12km/h or less; and

[s 16]

- (f) is no more than 850mm at the vehicle's widest part; and
- (g) weighs 60kg or less when the vehicle is not carrying a person or other load.

16 Who is a *driver*

- (1) A *driver* is the person who is driving a vehicle (except a motorbike, bicycle, animal or animal-drawn vehicle).
- (2) However, a *driver* does not include a person pushing a motorised wheelchair.

17 Who is a *rider*

- (1) A *rider* is the person who is riding a motorbike, bicycle, animal or animal-drawn vehicle.
- (2) A *rider* does not include—
 - (a) a passenger; or
 - (b) a person walking beside and pushing a bicycle.

18 Pedestrian includes personal mobility device user

A *pedestrian* includes a person who is using a personal mobility device, unless otherwise expressly stated in this regulation.

Note—

See also the Act, schedule 4, definition *pedestrian*.

19 Reference to driver includes rider etc.

Unless otherwise expressly stated in this regulation, a reference in this regulation (except in this division)—

- (a) to a *driver*, includes a reference to a rider; and
- (b) to *driving*, includes a reference to riding.

Part 3 Speed limits

20 Obeying the speed limit

A driver must not drive at a speed over the speed limit applying to the driver for the length of road where the driver is driving.

Maximum penalty—40 penalty units.

Note—

See also the Criminal Code, section 328A (Dangerous operation of a vehicle) and sections 83 (Careless driving of motor vehicles) and 84 (Dangerous driving of vehicles (other than motor vehicles) etc.) of the Act.

21 Speed limit where a speed limit sign applies

- (1) The speed limit applying to a driver for a length of road to which a speed limit sign applies is the number of kilometres per hour indicated by the number on the sign.
- (2) A speed limit sign on a road applies to the length of road beginning at the sign and ending at the nearest of the following—
 - (a) a speed limit sign on the road with a different number on the sign;
 - (b) an end speed limit sign or speed derestriction sign on the road;
 - (c) if the road ends at a T-intersection or dead end—the end of the road.

[s 22]

Examples—



Speed limit sign (Standard sign)

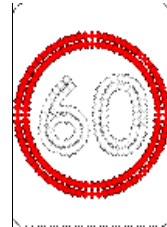

Speed limit sign (Variable illuminated message sign)

Other signs



End speed limit sign



Speed derestriction sign

22 Speed limit in a speed limited area

- (1) The speed limit applying to a driver for any length of road in a speed limited area is the number of kilometres per hour indicated by the number on the area speed limit sign on a road into the area, unless another speed limit applies to the driver for the length of road under another section of this part.

Example of another speed limit—

Although an area speed limit sign on a road into a speed limited area may indicate a speed limit of 60km/h, a particular length of road in the area may have a school zone sign indicating a 40km/h speed limit for that length of road.

- (2) A ***speed limited area*** is the network of roads in an area with—

- (a) an area speed limit sign on each road into the area, indicating the same number; and
 - (b) an end area speed limit sign on each road out of the area.
- (3) In this section—

road, in subsection (2)(a) and (b), does not include a road-related area.

Examples—



Area speed limit sign



End area speed limit sign

23 Speed limit in a school zone

- (1) The speed limit applying to a driver for any length of road in a school zone is the number of kilometres per hour indicated by the number on the school zone sign on a road, or the road, into the zone.
- (2) A **school zone** is—
 - (a) if there is a school zone sign and an end school zone sign, or a speed limit sign with a different number on the sign, on a road—that length of road; or
 - (b) if there is a school zone sign on a road that ends in a dead end and there is no sign mentioned in paragraph (a), on the length of road beginning at the sign and ending at the dead end—that length of road.

[s 24]

Examples—



School zone sign



End school zone sign

24 Speed limit in a shared zone

- (1) The speed limit applying to a driver for any length of road in a shared zone is the number of kilometres per hour indicated by the number on the shared zone sign on a road, or the road, into the zone.
- (2) A *shared zone* is—
 - (a) if there is a shared zone sign and an end shared zone sign on a road and there is no intersection on the length of road between the signs—that length of road; or
 - (b) if there is a shared zone sign on a road that ends in a dead end and there is no intersection on the length of road beginning at the sign and ending at the dead end—that length of road; or
 - (c) a network of roads in an area with—
 - (i) a shared zone sign on each road into the area indicating the same number; and
 - (ii) an end shared zone sign on each road out of the area; or
 - (d) a road related area that is between a shared zone sign that relates to the area and an end shared zone sign that relates to the area.
- (3) In subsection (2)(c)(i) and (ii)—

road does not include a road-related area.

Examples—



Shared zone sign



End shared zone sign

24A Speed limit for certain vehicles

- (1) This section applies to a driver despite a higher speed limit that would otherwise apply to the driver under this part.
- (2) The speed limit applying to the following drivers for a length of road where the driver is driving is—
 - (a) for a driver driving a tractor towing a sugar cane trailer—50km/h;
 - (b) for a driver driving an oversize vehicle that is required to travel with a pilot or escort vehicle—80km/h;
 - (c) for a driver driving a road train—90km/h;
 - (d) for a driver driving a bus with a GVM over 5t, or another vehicle with a GVM over 12t—100km/h.
- (3) In this section—

sugar cane trailer means a trailer—

- (a) with an ATM within the meaning of the Standards and Safety Regulation of not more than 20t; and
- (b) designed for carrying sugar cane.

tractor does not include a motor vehicle built to tow a semitrailer.

[s 25]

25 Speed limit elsewhere

- (1) If a speed limit sign does not apply to a length of road and the length of road is not in a speed limited area, school zone or shared zone, the speed limit applying to a driver for the length of road is the default speed limit.
- (2) The *default speed limit* applying to a driver for a length of road is—
 - (a) for a road in a built-up area—50km/h; or
 - (b) for a road that is not in a built-up area—100km/h.

Part 4 Making turns

Division 1 Left turns

26 Application of division to roundabouts, road-related areas and adjacent land

- (1) This division does not apply to a driver entering or leaving a roundabout.
- (2) This division applies to a driver turning left from a road into a road-related area or adjacent land, or from a road-related area into a road, as if the driver were turning left at an intersection.
- (3) In this section—
road does not include a road-related area.

27 Starting a left turn from a road (except a multi-lane road)

- (1) A driver turning left at an intersection from a road (except a multi-lane road) must approach and enter the intersection from as near as practicable to the far left side of the road.
Maximum penalty—20 penalty units.

- (1A) Subsection (1) also applies to a rider of a bicycle who approaches and enters an intersection from a bicycle storage area.
- (1B) Despite subsection (1), if there is space in a bicycle storage area for 2 riders of bicycles to be next to each other, the rider on the right may approach and enter the intersection as near as practicable to the right side of the other rider, but only if that other rider approaches and enters the intersection in accordance with this section.
- (2) In this section—
road does not include a road-related area.

Example—

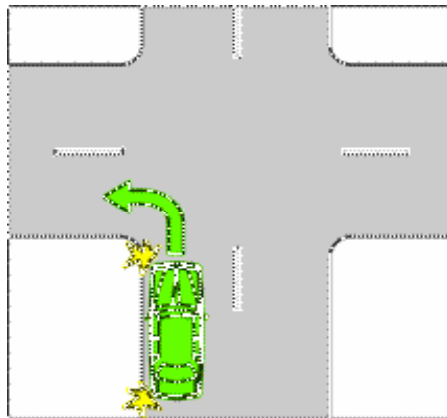

Starting a left turn from a road (except a multi-lane road)

28 Starting a left turn from a multi-lane road

- (1) A driver turning left at an intersection from a multi-lane road must approach and enter the intersection from within the left lane unless—
- (a) the driver is required or permitted to approach and enter the intersection from within another marked lane under section 88(1), 92 or 159; or

[s 28]

- (b) the driver is turning, at B lights or a white traffic arrow, in accordance with part 17, division 2; or
- (c) subsection (1A) or (2) applies to the driver.

Maximum penalty—20 penalty units.

Example for subsection (1)(a)—

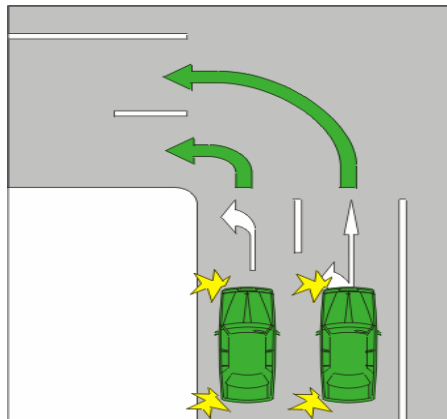

Starting a left turn on a multi-lane road with traffic lane arrows as required or permitted under section 92

- (1A) A driver turning left at an intersection from a multi-lane road that has a slip lane must approach and enter the intersection—
 - (a) from within the slip lane; or
 - (b) if there is an obstruction that prevents the driver from entering the intersection from within the slip lane—from within the left lane.

Maximum penalty—20 penalty units.

- (2) A driver may approach and enter the intersection from the marked lane next to the left lane as well as, or instead of, the left lane if—
 - (a) the driver's vehicle, together with any load or projection, is 7.5m long, or longer; and
 - (b) the vehicle displays a do not overtake turning vehicle sign; and

- (c) any part of the vehicle is within 50m of the nearest point of the intersection; and
- (d) it is not practicable for the driver to turn left from within the left lane; and
- (e) the driver can safely occupy the next marked lane and can safely turn left at the intersection by occupying the next marked lane, or both lanes.

Example—

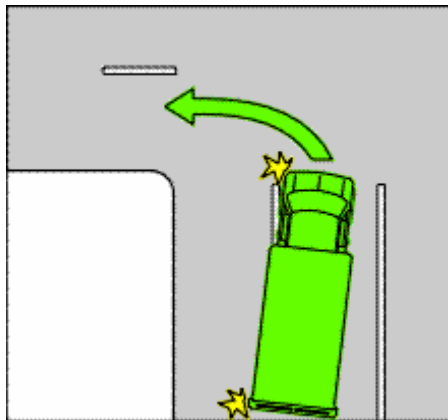

Long vehicle turning left from the left lane and next marked lane

- (2A) If there is a bicycle storage area before an intersection that extends across 1 or more marked lanes of a multi-lane road, a rider of a bicycle turning left must approach and enter the intersection from within the part of the bicycle storage area that is directly in front of the left marked lane or of a bicycle lane that is on the left side of the road.

Maximum penalty—20 penalty units.

- (3) In this section—

left lane means—

- (a) the marked lane nearest to the far left side of the road; or

[s 29]

- (b) if there is an obstruction (for example, a parked car or roadworks) in that marked lane—the marked lane nearest to that marked lane that is not obstructed.

marked lane, for a driver, does not include a special purpose lane in which the driver is not permitted to drive.

Examples of do not overtake turning vehicle signs—



29 Making a left turn as indicated by a turn line

- (1) If a driver is turning left at an intersection and there is a turn line indicating how the turn is required to be made, the driver must make the turn as indicated by the turn line unless—
- (a) the driver is turning, at B lights or traffic arrows, in accordance with part 17, division 2; or
 - (b) subsection (2) applies to the driver.

Maximum penalty—20 penalty units.

Example—

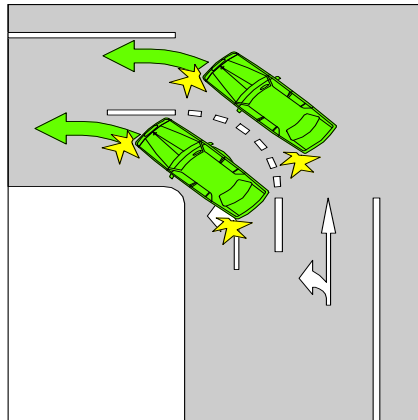

Making a left turn as indicated by a turn line

- (2) A driver may turn left at an intersection other than as indicated by a turn line if—
- (a) the driver's vehicle, together with any load or projection, is 7.5m long, or longer; and
 - (b) the vehicle displays a do not overtake turning vehicle sign; and
 - (c) it is not practicable for the driver to turn left as indicated by the turn line; and
 - (d) the driver can safely turn left other than as indicated by the turn line.

Examples of do not overtake turning vehicle signs—

DO NOT OVERTAKE TURNING VEHICLE



[s 30]

Division 2 Right turns

30 Application of division to certain right turns

- (1) This division does not apply to—
 - (a) a driver turning right at an intersection where there is a hook turn only sign; or
 - (b) the rider of a bicycle making a hook turn under division 3; or
 - (c) a driver making a U-turn; or
 - (d) a driver entering or leaving a roundabout.
- (2) This division applies to a driver turning right from a road into a road-related area or adjacent land, or from a road-related area into a road, as if the driver were turning right at an intersection.
- (3) In this section—

road does not include a road-related area.

31 Starting a right turn from a road (except a multi-lane road)

- (1) A driver turning right at an intersection from a road (except a multi-lane road) must approach and enter the intersection in accordance with this section.

Maximum penalty—20 penalty units.
- (2) If the road has a dividing line or median strip, the driver must approach and enter the intersection from the left of, parallel to, and as near as practicable to, the dividing line or median strip.
- (3) If the road does not have a dividing line or median strip and is not a one-way road, the driver must approach and enter the intersection from the left of, parallel to, and as near as practicable to, the centre of the road.

- (4) If the road is a one-way road, the driver must approach and enter the intersection from as near as practicable to the far right side of the road.
- (4A) Subsections (2), (3) and (4) also apply to a rider of a bicycle who approaches and enters an intersection from a bicycle storage area.
- (4B) Despite subsections (2), (3) and (4), if there is space in a bicycle storage area for 2 riders of bicycles to be next to each other, the rider on the left may approach and enter the intersection as near as practicable to the left side of the other rider, but only if that other rider approaches and enters the intersection in accordance with this section.
- (5) In this section—
road does not include a road-related area.

Examples—

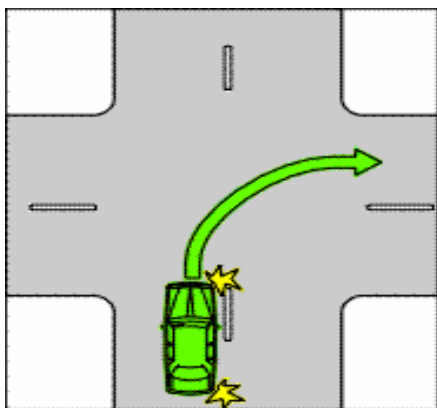

Example 1
Starting a right turn from a road
with a dividing line

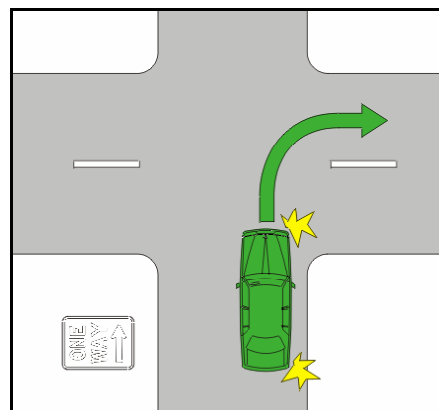

Example 2
Starting a right turn from a
one-way road

[s 32]

32 Starting a right turn from a multi-lane road

- (1) A driver turning right at an intersection from a multi-lane road must approach and enter the intersection from within the right lane unless—
 - (a) the driver is required or permitted to approach and enter the intersection from within another marked lane in accordance with section 89(1), 92 or 159; or
 - (b) the driver is turning, at B lights or a white traffic arrow, in accordance with part 17, division 2; or
 - (c) subsection (2) applies to the driver.

Maximum penalty—20 penalty units.

Example for subsection (1)(a)—

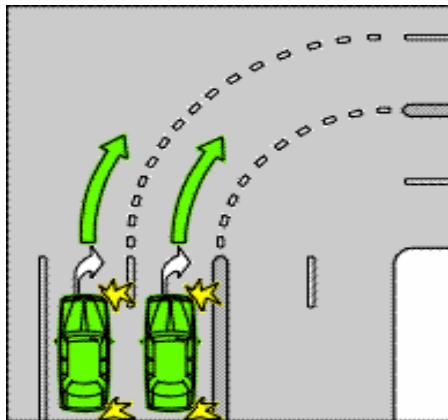

Starting a right turn on a multi-lane road with traffic lane arrows as required or permitted under section 92

- (2) A driver may approach and enter the intersection from the marked lane next to the right lane as well as, or instead of, the right lane if—
 - (a) the driver's vehicle, together with any load or projection, is 7.5m long, or longer; and
 - (b) the vehicle displays a do not overtake turning vehicle sign; and

- (c) any part of the vehicle is within 50m of the nearest point of the intersection; and
 - (d) it is not practicable for the driver to turn right from within the right lane; and
 - (e) the driver can safely occupy the next marked lane and can safely turn right at the intersection by occupying the next marked lane, or both lanes.
- (2A) If there is a bicycle storage area before an intersection that extends across 1 or more marked lanes of a multi-lane road, a rider of a bicycle turning right (but not making a hook turn) must approach and enter the intersection from within the part of the bicycle storage area that is directly in front of the right marked lane or of a bicycle lane that is on the right side of the road.

Maximum penalty—20 penalty units.

- (3) In this section—

marked lane, for a driver, does not include a special purpose lane in which the driver is not permitted to drive.

right lane means—

- (a) the marked lane nearest to the dividing line or median strip on the road; or
- (b) if there is an obstruction (for example, a parked car or roadworks) in that marked lane—the marked lane nearest to that marked lane that is not obstructed.

Examples of do not overtake turning vehicle signs—



[s 33]

33 Making a right turn

- (1) A driver turning right at an intersection must make the turn in accordance with this section unless—
 - (a) the driver is turning, at B lights or traffic arrows, in accordance with part 17, division 2; or
 - (b) subsection (4) applies to the driver.

Maximum penalty—20 penalty units.

- (2) If there is a turn line indicating how the turn is required to be made, the driver must make the turn as indicated by the turn line.
- (3) If there is no turn line indicating how the turn is required to be made, the driver must make the turn so the driver—
 - (a) passes as near as practicable to the right of the centre of the intersection; and
 - (b) turns into the left of the centre of the road the driver is entering, unless the driver is entering a one-way road.

Examples—

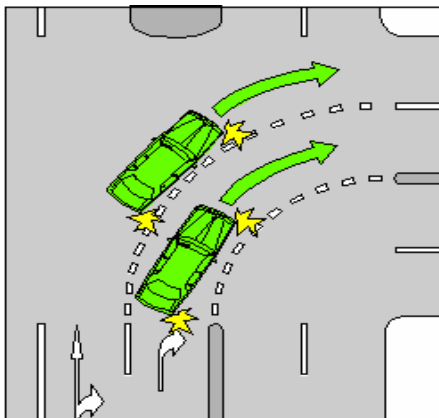

Making a right turn as indicated by turn lines

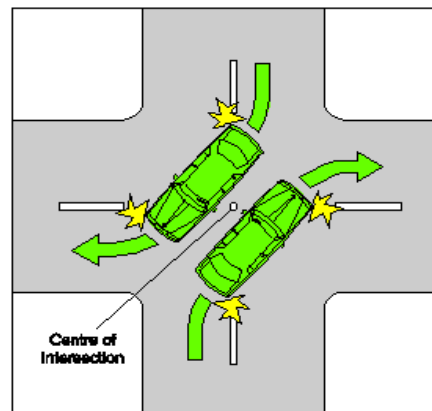

Making a right turn from a road with no turn lines indicating how to make the turn (diagram shows the location of the centre of the intersection)

- (4) A driver may turn right other than as indicated by a turn line if—
- the driver's vehicle, together with any load or projection, is 7.5m long, or longer; and
 - the vehicle displays a do not overtake turning vehicle sign; and
 - it is not practicable for the driver to turn right as indicated by the turn line; and
 - the driver can safely make the turn other than as indicated by the turn line.

Examples of do not overtake turning vehicle signs—



Division 3 Hook turns at intersections

34 Making a hook turn at a hook turn only sign

- (1) A driver turning right at an intersection with traffic lights and a hook turn only sign must turn right by making a hook turn in accordance with this section.

Maximum penalty—20 penalty units.

- (2) To make a **hook turn**, the driver must take, in sequence, each of the following steps—
- 1 Approach and enter the intersection from as near as practicable to the far left side of the road that the driver is leaving.

[s 34]

- 2 Move forward—
 - (a) keeping as near as practicable to the far left side of the intersection; and
 - (b) keeping clear of any marked foot crossing;until the driver is as near as practicable to the far side of the road that the driver is entering.
 - 3 Remain at the position reached under step 2 until the traffic lights on the road that the driver is entering change to green.
 - 4 Turn right into the road that the driver is entering.
- (3) In this section—

road does not include a road-related area.

Examples—



Hook turn only sign

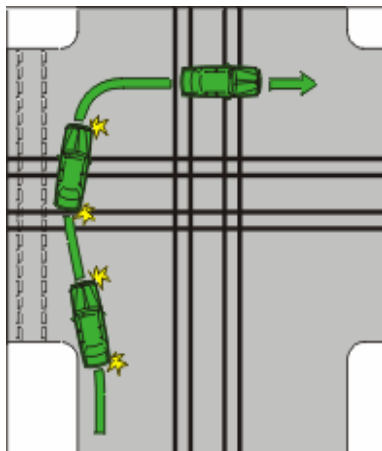

Making a hook turn at a hook turn only sign

35 Optional hook turn by a bicycle rider

(1) The rider of a bicycle turning right at an intersection, without a hook turn only sign or a no hook turn by bicycles sign, may turn right at the intersection by making—

- (a) a right turn under division 2; or
- (b) a hook turn under this section.

(2) The rider must make a hook turn under this section in accordance with subsection (3).

Maximum penalty—20 penalty units.

(3) To make a ***hook turn*** under this section, the rider must take, in sequence, each of the following steps—

- 1 Approach and enter the intersection from as near as practicable to the far left side of the road that the rider is leaving.
- 2 Move forward—
 - (a) keeping as near as practicable to the far left side of the intersection; and
 - (b) keeping clear of any marked foot crossing; and
 - (c) keeping clear, as far as practicable, of any driver turning left from the left of the intersection;until the rider is as near as practicable to the far side of the road that the rider is entering.
- 3 If there are traffic lights at the intersection, remain at the position reached under step 2 until the traffic lights on the road that the rider is entering change to green.
- 4 If there are no traffic lights at the intersection, remain at the position reached under step 2 until the rider has given way to approaching drivers on the road that the rider is leaving.
- 5 Turn right into the road that the rider is entering.

(4) To make a ***hook turn*** under this section at an intersection that has a bicycle hook turn storage area on the left side of the

[s 35]

intersection as the rider approaches the intersection, the rider must take the following initial 2 steps instead of the initial 2 steps listed in subsection (3)—

- 1 Approach the intersection from the far left side of the road the rider is leaving and enter the intersection by moving into the bicycle hook turn storage area, keeping clear of any marked foot crossing.
- 2 Move forward in the bicycle hook turn storage area until the rider is as near as practicable to the far side of the road that the rider is entering.

Example 1—

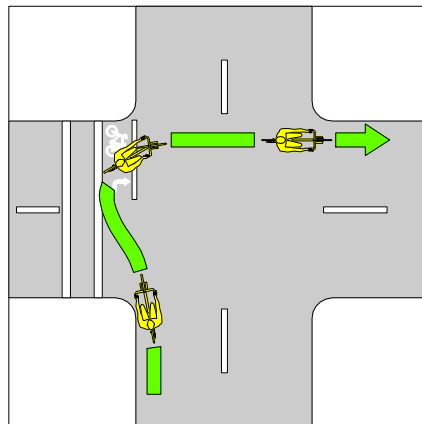

Bicycle rider making a hook turn at an intersection without traffic lights where there is a bicycle hook turn storage area

Example 2—

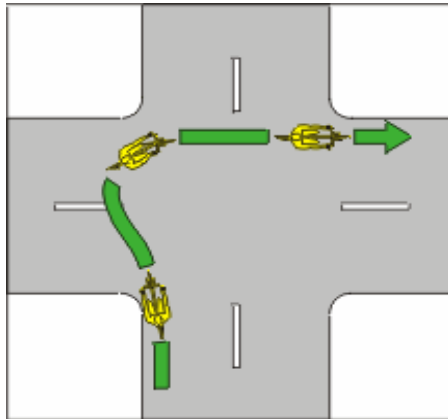

Bicycle rider making a hook turn at an intersection without traffic lights

(5) In this section—

bicycle hook turn storage area—

- (a) means an area between an intersection and a marked foot crossing, or if there is no marked foot crossing, a stop line, before the intersection that has painted on it 1 or more bicycle symbols and 1 or more right traffic lane arrows; and
- (b) includes any line that delineates the right side of the area, and any line that delineates the left side of the area that is not also a stop line or part of a marked foot crossing and excludes any bicycle storage area.

36 Bicycle rider making a hook turn contrary to no hook turn by bicycles sign

The rider of a bicycle must not make a hook turn at an intersection that has a no hook turn by bicycles sign.

Maximum penalty—20 penalty units.

[s 37]

Example—



No hook turn by bicycles sign

Division 4 U-turns

37 Beginning a U-turn

A driver must not begin a U-turn unless—

- (a) the driver has a clear view of any approaching traffic;
and
- (b) the driver can safely make the U-turn without
unreasonably obstructing the free movement of traffic.

Maximum penalty—20 penalty units.

38 Giving way when making a U-turn

A driver making a U-turn must give way to all vehicles and pedestrians.

Maximum penalty—20 penalty units.

39 Making a U-turn contrary to a no U-turn sign

- (1) A driver must not make a U-turn at a break in a dividing strip on a road if there is a no U-turn sign at the break in the dividing strip.

Maximum penalty—20 penalty units.

- (2) A driver must not make a U-turn on a length of road to which a no U-turn sign applies.

Maximum penalty—20 penalty units.

- (3) A no U-turn sign on a road (except a no U-turn sign at an intersection or at a break in a dividing strip) applies to the length of road beginning at the sign and ending at the nearer of the following—
- (a) the next intersection on the road;
 - (b) if the road ends at a T-intersection or dead end—the end of the road.

Example of no U-turn signs—



No U-turn sign (Standard sign)



No U-turn sign (Variable illuminated message sign)

40 Making a U-turn at an intersection with traffic lights

A driver must not make a U-turn at an intersection with traffic lights unless there is a U-turn permitted sign at the intersection.

Maximum penalty—20 penalty units.

Example of U-turn permitted sign—



[s 41]

41 Making a U-turn at an intersection without traffic lights

A driver must not make a U-turn at an intersection without traffic lights if there is a no U-turn sign at the intersection.

Maximum penalty—20 penalty units.

42 Starting a U-turn at an intersection

A driver making a U-turn at an intersection must start the U-turn—

- (a) if the road where the driver is turning has a dividing line or median strip—from the marked lane nearest, or as near as practicable, to the dividing line or median strip; or
- (b) in any other case—from the left of the centre of the road.

Maximum penalty—20 penalty units.

Example—

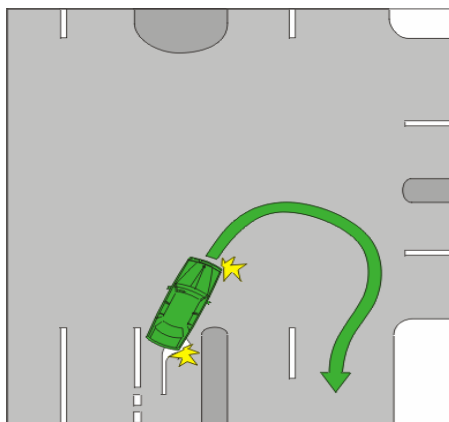

Starting a U-turn on a road with a median strip

43 Section number not used

Part 5 Change of direction and stop signals

Division 1 Change of direction signals

44 Division does not apply to entering or leaving a roundabout

This division does not apply to a driver entering, in or leaving a roundabout.

45 What is *changing direction*

- (1) A driver *changes direction* if—
 - (a) the driver changes direction to the left; or
 - (b) the driver changes direction to the right.
- (2) A driver *changes direction to the left* by doing any of the following—
 - (a) turning left;
 - (b) changing marked lanes to the left;
 - (c) diverging to the left;
 - (d) entering a marked lane, or a line of traffic, to the left;
 - (e) moving to the left from a stationary position;
 - (f) turning left into a marked lane, or a line of traffic, from a median strip parking area;
 - (g) at a T-intersection where the continuing road curves to the right—leaving the continuing road to proceed straight ahead onto the terminating road.

[s 45]

- (3) A driver *changes direction to the right* by doing any of the following—
- (a) turning right;
 - (b) changing marked lanes to the right;
 - (c) diverging to the right;
 - (d) entering a marked lane, or a line of traffic, to the right;
 - (e) moving to the right from a stationary position;
 - (f) turning right into a marked lane, or a line of traffic, from a median strip parking area;
 - (g) making a U-turn;
 - (h) at a T-intersection where the continuing road curves to the left—leaving the continuing road to proceed straight ahead onto the terminating road.

Examples for subsections (2)(g) and (3)(h)—

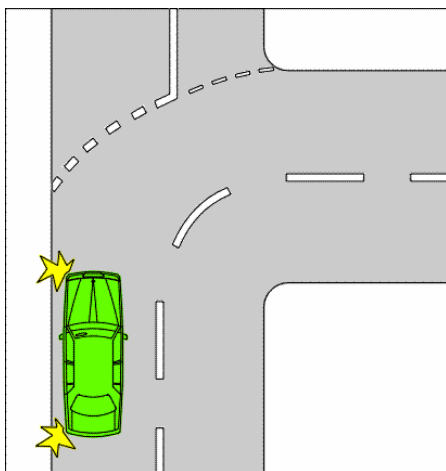

Example 1

Driver indicating change of direction at a T-intersection where the continuing road curves to the right and the driver is proceeding straight ahead onto the terminating road

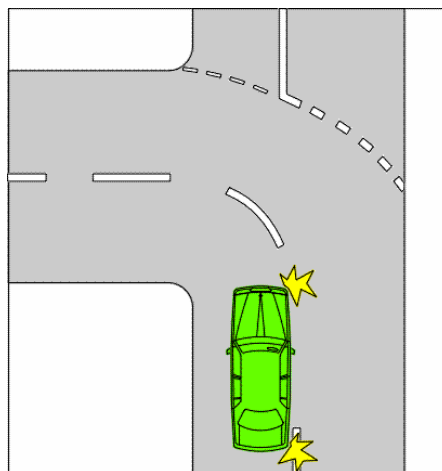

Example 2

Driver indicating change of direction at a T-intersection where the continuing road curves to the left and the driver is proceeding straight ahead onto the terminating road

46 Giving a left change of direction signal

- (1) Before a driver changes direction to the left, the driver must give a left change of direction signal in accordance with section 47 for long enough to comply with—
 - (a) subsection (2); and
 - (b) if subsection (3) applies to the driver—subsection (3).Maximum penalty—20 penalty units.
- (2) The driver must give the change of direction signal for long enough to give sufficient warning to other drivers and pedestrians.
- (3) If the driver is about to change direction by moving from a stationary position at the side of the road or in a median strip

[s 47]

parking area, the driver must give the change of direction signal for at least 5 seconds before the driver changes direction.

- (4) The driver must stop giving the change of direction signal as soon as the driver completes the change of direction.

Maximum penalty—20 penalty units.

- (5) This section does not apply to a driver if the driver's vehicle is not fitted with direction indicator lights.

47 How to give a left change of direction signal

The driver of a vehicle must give a left change of direction signal by operating the vehicle's left direction indicator lights.

48 Giving a right change of direction signal

- (1) Before a driver changes direction to the right, the driver must give a right change of direction signal in accordance with section 49 for long enough to comply with—

- (a) subsection (2); and

- (b) if subsection (3) applies to the driver—subsection (3).

Maximum penalty—20 penalty units.

- (2) The driver must give the change of direction signal for long enough to give sufficient warning to other drivers and pedestrians.
- (3) If the driver is about to change direction by moving from a stationary position at the side of the road or in a median strip parking area, the driver must give the change of direction signal for at least 5 seconds before the driver changes direction.
- (3A) Subsection (3) does not apply to the rider of a bicycle that is stopped in traffic but not parked.
- (4) The driver must stop giving the change of direction signal as soon as the driver completes the change of direction.

Maximum penalty—20 penalty units.

- (5) This section does not apply to—
- (a) the driver of a tram that is not fitted with direction indicator lights; or
 - (b) the rider of a bicycle making a hook turn.

49 How to give a right change of direction signal

- (1) The driver of a vehicle must give a right change of direction signal by operating the vehicle's right direction indicator lights.
- (2) However, if the vehicle's direction indicator lights are not in working order or are not clearly visible, or the vehicle is not fitted with direction indicator lights, the driver must give the change of direction signal by—
- (a) giving a hand signal in accordance with section 50; or
 - (b) using a mechanical signalling device fitted to the vehicle.

50 How to give a right change of direction signal by giving a hand signal

To give a hand signal for changing direction to the right, the driver must extend the right arm and hand horizontally and at right angles from the right side of the vehicle, with the hand open and the palm facing the direction of travel.

[s 51]

Example—

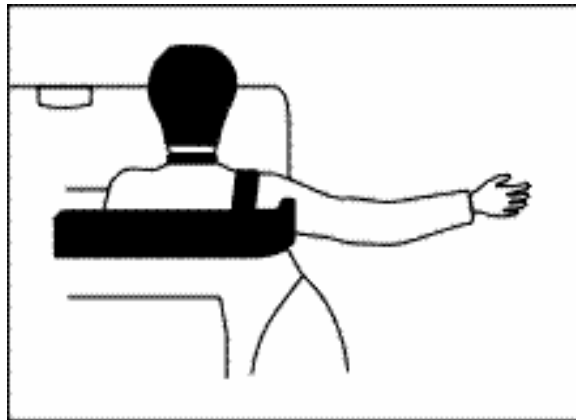

Giving a hand signal for changing direction to the right

51 When use of direction indicator lights permitted

The driver of a vehicle must not operate a direction indicator light except—

- (a) to give a change of direction signal when the driver is required to give the signal under this regulation; or
- (b) as part of the vehicle's hazard warning lights.

Maximum penalty—20 penalty units.

Division 2 Stop signals

52 Division does not apply to bicycle riders or certain tram drivers

This division does not apply to—

- (a) the rider of a bicycle; or
- (b) the driver of a tram that is not fitted with brake lights.

53 Giving a stop signal

- (1) A driver must give a stop signal in accordance with section 54 before stopping or when suddenly slowing.

Maximum penalty—20 penalty units.

- (2) If the driver is stopping, the driver must give the stop signal for long enough to give sufficient warning to other road users.

Maximum penalty—20 penalty units.

- (3) If the driver is slowing suddenly, the driver must give the stop signal while slowing.

Maximum penalty—20 penalty units.

54 How to give a stop signal

- (1) The driver of a vehicle must give a stop signal by means of the vehicle's brake lights.

- (2) However, if the vehicle's brake lights are not in working order or are not clearly visible, or the vehicle is not fitted with brake lights, the driver must give the stop signal by—

- (a) giving a hand signal in accordance with section 55; or
- (b) using a mechanical signalling device fitted to the vehicle.

55 How to give a stop signal by giving a hand signal

- (1) To give a hand signal for stopping or suddenly slowing, the driver must extend the right arm and hand at right angles from the right side of the vehicle with—

- (a) the upper arm horizontal and the forearm and hand pointing upwards; and
- (b) the hand open and the palm facing the direction of travel.

- (2) However, the rider of a motorbike may give the hand signal by extending the left arm and hand at right angles from the left side of the motorbike with—

[s 56]

- (a) the upper arm horizontal and the forearm and hand pointing upwards; and
- (b) the hand open and the palm facing the direction of travel.

Example—

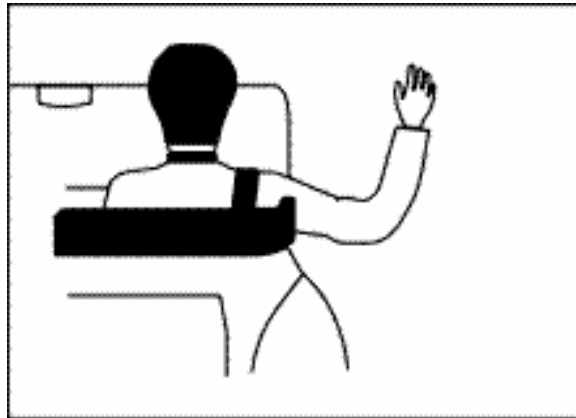

Giving a hand signal for stopping or suddenly slowing

Part 6 Traffic lights, traffic arrows and twin red lights

Division 1 Obeying traffic lights and traffic arrows

56 Stopping on a red traffic light or arrow

- (1) A driver approaching or at traffic lights showing a red traffic light—
 - (a) must stop—

- (i) if there is a stop line at or near the traffic lights—as near as practicable to, but before reaching, the stop line; or
 - (ii) if there is a stop here on red signal sign at or near the traffic lights, but no stop line—as near as practicable to, but before reaching, the sign; or
 - (iii) if there is no stop line or stop here on red signal sign at or near the traffic lights—as near as practicable to, but before reaching, the nearest or only traffic lights; and
- (b) must not proceed until—
- (i) the traffic lights change to green or flashing yellow or show no traffic light; or
 - (ii) a green or flashing yellow traffic arrow is showing, if the driver is turning in the direction indicated by the arrow.

Maximum penalty—20 penalty units.

Example for subsection (1)(a)(ii)—

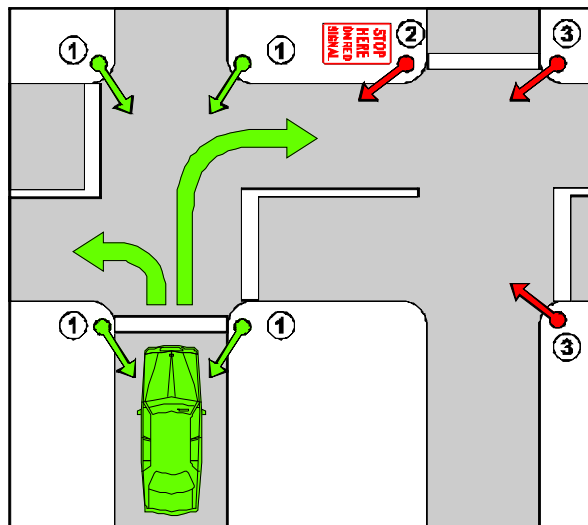

Stopping at a stop here on red signal sign on a road the driver is entering

[s 56]

- (1A) However, if the traffic lights are at an intersection with a left turn on red after stopping sign and the driver is turning left at the intersection, the driver may turn left after stopping.
- (2) A driver approaching or at traffic arrows showing a red traffic arrow who is turning in the direction indicated by the arrow—
- (a) must stop—
 - (i) if there is a stop line at or near the traffic arrows—as near as practicable to, but before reaching, the stop line; or
 - (ii) if there is a stop here on red arrow sign at or near the traffic arrows, but no stop line—as near as practicable to, but before reaching, the sign; or
 - (iii) if there is no stop line or stop here on red arrow sign at or near the traffic arrows—as near as practicable to, but before reaching, the nearest or only traffic arrows; and
 - (b) must not proceed until—
 - (i) the traffic arrows change to green or flashing yellow; or
 - (ii) the traffic lights show a green or flashing yellow traffic light and there is no red or yellow traffic arrow showing.

Maximum penalty—20 penalty units.

Examples—



Stop here on red signal sign



Stop here on red arrow sign

-
- (3) If there is a bicycle storage area before any traffic lights referred to in subsection (1) or (2), a reference to the stop line in subsection (1)(a) or (2)(a)—
- (a) in the case of a driver of a motor vehicle, is a reference to the first stop line that the driver comes, or came, to in approaching the lights; or
 - (b) in the case of a rider of a bicycle, is a reference to the stop line that is nearest to the intersection.

57 Stopping for a yellow traffic light or arrow

- (1) A driver who is approaching, or at, traffic lights showing a yellow traffic light—
- (a) must stop—
 - (i) if there is a stop line at or near the traffic lights and the driver can stop safely before reaching the stop line—as near as practicable to, and before reaching, the stop line; or
 - (ii) if there is no stop line at or near the traffic lights and the driver can stop safely before reaching the traffic lights—as near as practicable to, and before reaching, the nearest traffic lights; or
 - (iii) if the traffic lights are at an intersection and the driver can not stop safely under subparagraph (i) or (ii), but can stop safely before entering the intersection—before entering the intersection; and
 - (b) must not proceed until the traffic lights—
 - (i) change to green or flashing yellow; or
 - (ii) show no traffic light.

Maximum penalty—20 penalty units.

- (2) A driver who is approaching, or at, traffic arrows showing a yellow traffic arrow, and turning in the direction indicated by the arrow—
- (a) must stop—

[s 58]

- (i) if there is a stop line at or near the traffic arrows and the driver can stop safely before reaching the stop line—as near as practicable to, and before reaching, the stop line; or
 - (ii) if there is no stop line at or near the traffic arrows and the driver can stop safely before reaching the traffic arrows—as near as practicable to, and before reaching, the nearest traffic arrows; or
 - (iii) if the traffic arrows are at an intersection and the driver can not stop safely under subparagraph (i) or (ii), but can stop safely before entering the intersection—before entering the intersection; and
- (b) must not proceed until the traffic arrows—
- (i) change to green or flashing yellow; or
 - (ii) show no traffic arrow.

Maximum penalty—20 penalty units.

- (3) If the traffic lights or arrows are at an intersection and the driver can not stop safely under subsection (1) or (2) and enters the intersection, the driver must leave the intersection as soon as the driver can do so safely.

Maximum penalty—20 penalty units.

- (4) If there is a bicycle storage area before any traffic lights referred to in subsection (1) or (2), a reference to the stop line in subsection (1)(a) or (2)(a)—
- (a) in the case of a driver of a motor vehicle, is a reference to the first stop line that the driver comes, or came, to in approaching the lights; or
 - (b) in the case of a rider of a bicycle, is a reference to the stop line that is nearest to the intersection.

58 Exceptions to stopping for a red or yellow traffic light

- (1) A driver approaching or at traffic lights showing a red or yellow traffic light does not have to stop if a green traffic

arrow is also showing and the driver is turning in the direction indicated by the arrow.

- (2) A driver turning at an intersection with traffic lights who approaches, or is at, a red traffic light on the road that the driver is entering does not have to stop for the red traffic light if there is no stop line or stop here on red signal sign at or near the traffic light.

59 Proceeding through a red traffic light

- (1) If traffic lights at an intersection, bicycle crossing or marked foot crossing are showing a red traffic light, a driver facing the red traffic light must not enter the intersection, bicycle crossing or marked foot crossing.

Maximum penalty—20 penalty units.

- (2) However, if the traffic lights are at an intersection with a left turn on red after stopping sign and the driver is turning left at the intersection, the driver may turn left before the traffic lights change to green or flashing yellow.

Example—



Left turn on red after stopping sign

- (3) Subsection (1) does not apply to a driver if section 58(1) applies to the driver.

60 Proceeding through a red traffic arrow

If traffic arrows at an intersection or marked foot crossing are showing a red traffic arrow, and a driver is turning in the

[s 60A]

direction indicated by the arrow, the driver must not enter the intersection or marked foot crossing.

Maximum penalty—20 penalty units.

60A Proceeding through a bicycle storage area before a red traffic light or arrow

- (1) If there is a bicycle storage area before traffic lights that are showing a red traffic light, a driver of a motor vehicle must not allow any part of the vehicle to enter the bicycle storage area.

Maximum penalty—20 penalty units.

- (2) If there is a bicycle storage area before traffic arrows that are showing a red traffic arrow, and a driver of a motor vehicle is turning in the direction indicated by the arrow, the driver must not allow any part of the vehicle to enter the bicycle storage area.

Maximum penalty—20 penalty units.

61 Proceeding when traffic lights or arrows at an intersection change to red or yellow

- (1) This section applies to a driver—
- (a) at an intersection with traffic lights showing a green traffic light who has stopped after the stop line, stop here on red signal sign, or nearest or only traffic lights, at the intersection and is not making a hook turn at the intersection; or
 - (b) at an intersection with traffic arrows showing a green traffic arrow who is turning in the direction indicated by the arrow and has stopped after the stop line, stop here on red arrow sign, or nearest or only traffic arrows, at the intersection.

Example—

A driver may stop after the stop line at an intersection with traffic lights showing a green traffic light, and not proceed through the intersection, because traffic is congested.

-
- (2) If the traffic lights or arrows change to red or yellow while the driver is stopped and the driver has not entered the intersection, the driver must not enter the intersection.

Maximum penalty—20 penalty units.

- (3) However, if the traffic lights are at an intersection with a left turn on red after stopping sign and the driver is turning left at the intersection, the driver may turn left after stopping.

- (4) Also, subsection (2) does not apply to a driver if section 58(1) applies to the driver.

- (5) If the traffic lights or arrows change to red or yellow while the driver is stopped and the driver has entered the intersection, the driver must leave the intersection as soon as the driver can do so safely.

Maximum penalty—20 penalty units.

Division 2 Giving way at traffic lights and traffic arrows

62 Giving way when turning at intersection with traffic lights

- (1) A driver turning at an intersection with traffic lights must give way to—
- (a) any pedestrian at or near the intersection who is crossing the road the driver is entering; and
 - (aa) any rider of a bicycle at or near the intersection who is crossing the road the driver is entering on a marked foot crossing; and
 - (b) if the driver is turning left at a left turn on red after stopping sign at the intersection—
 - (i) any vehicle approaching from the right, turning right at the intersection into the road the driver is entering, or making a U-turn at the intersection; and

[s 62]

- (ii) any pedestrian or rider of a bicycle at or near the intersection who is on the road the driver is leaving; and
- (c) if the driver is turning right—any oncoming vehicle that is going straight ahead or turning left at the intersection (except a vehicle turning left using a slip lane).

Maximum penalty—20 penalty units.

- (2) However, a driver who is turning at an intersection with traffic arrows showing a green traffic arrow need not give way to an oncoming vehicle if the driver is turning in the direction indicated by the green traffic arrow.

Examples—

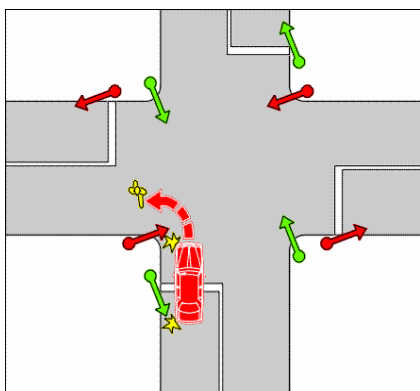

Example 1
Giving way to a pedestrian crossing the road the driver is entering

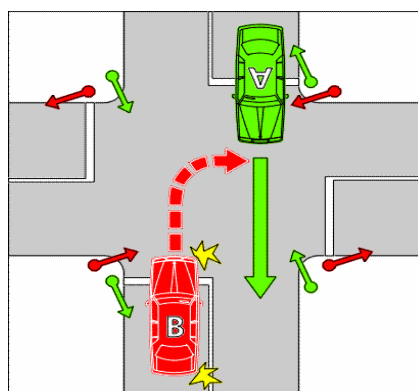

Example 2
Driver turning right giving way to an oncoming vehicle going straight ahead

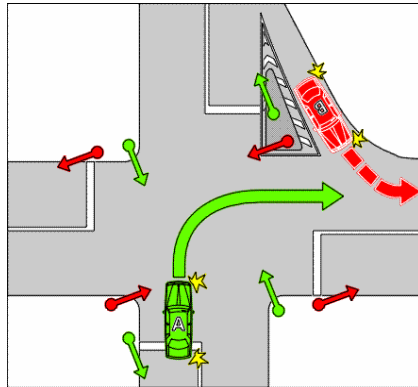

Example 3

Driver turning right does not have to give way to an oncoming vehicle that is turning left into the road the driver is entering using a slip lane

In example 1, the vehicle must give way to the pedestrian.

In examples 2 and 3, vehicle B must give way to vehicle A.

63 Giving way at an intersection with traffic lights not operating or only partly operating

- (1) This section applies to a driver at an intersection if—
 - (a) traffic lights at the intersection are not operating; or
 - (b) the traffic lights are showing only a flashing yellow traffic light.
- (2) If there is a traffic light-stop sign at the intersection, the driver must comply with section 67 as if the sign were a stop sign at an intersection without traffic lights.
Maximum penalty—20 penalty units.
- (3) If there is no traffic light-stop sign at the intersection, the driver must give way to vehicles and pedestrians at or near the intersection in accordance with section 72 or 73 as if the intersection were an intersection without traffic lights or a stop sign, stop line, give way sign or give way line.

[s 64]

Maximum penalty—20 penalty units.

Example—



Traffic light-stop sign

- (4) Subsection (3) does not apply if the intersection is a roundabout.
- (5) If the intersection is a roundabout, the driver must comply with section 114.

64 Giving way at a flashing yellow traffic arrow at an intersection

A driver turning in the direction indicated by a flashing yellow traffic arrow at an intersection with traffic lights must give way to—

- (a) any vehicle travelling on the road the driver is entering; and
- (b) any pedestrian at or near the intersection who is crossing the road the driver is entering; and
- (ba) any rider of a bicycle at or near the intersection who is crossing the road the driver is entering on a marked foot crossing; and
- (c) if the driver is turning right—any oncoming vehicle that is going straight ahead or turning left at the intersection (except a vehicle turning left using a slip lane).

Maximum penalty—20 penalty units.

65 Giving way at a marked foot crossing (except at an intersection) with a flashing yellow traffic light

- (1) This section applies to a driver approaching or at a marked foot crossing (except at or near an intersection) with a flashing yellow traffic light at the crossing.
- (2) The driver must—
 - (a) give way to any pedestrian or rider of a bicycle on the crossing; and
 - (b) not obstruct any pedestrian or rider of a bicycle on the crossing; and
 - (c) not overtake or pass a vehicle that is travelling in the same direction as the driver and is stopping, or has stopped, to give way at the crossing.

Maximum penalty—20 penalty units.

- (3) If there is no pedestrian or rider of a bicycle on the crossing, and no other vehicle travelling in the same direction as the driver that is stopping, or has stopped, to give way at the crossing, the driver may proceed through the crossing.

Division 3 Twin red lights (except at level crossings)

66 Stopping for twin red lights (except at level crossings)

- (1) A driver approaching or at twin red lights on a road (except at a level crossing) must stop in accordance with subsections (2) and (3).

Maximum penalty—20 penalty units.

- (2) If there is a stop line at or near the lights and the driver can stop safely before reaching the stop line, the driver must stop as near as practicable to, but before reaching, the stop line.
- (3) If there is no stop line at or near the lights and the driver can stop safely before reaching the lights, the driver must stop as near as practicable to, but before reaching, the lights.

[s 67]

- (4) If the driver stops for the lights, the driver must not proceed until the lights are not showing.

Maximum penalty—20 penalty units.

Part 7 Giving way

Division 1 Giving way at a stop sign, stop line, give way sign or give way line applying to the driver

67 Stopping and giving way at a stop sign or stop line at an intersection without traffic lights

- (1) This section applies to a driver at an intersection without traffic lights who is facing a stop sign or stop line.
- (2) The driver must stop as near as practicable to, but before reaching—

- (a) the stop line; or
(b) if there is no stop line—the intersection.

Maximum penalty—20 penalty units.

- (3) The driver must give way to a vehicle in, entering or approaching the intersection except—
- (a) an oncoming vehicle turning right at the intersection, if a stop sign, stop line, give way sign or give way line applies to the driver of the oncoming vehicle; or
(b) a vehicle turning left at the intersection using a slip lane; or
(c) a vehicle making a U-turn.

Maximum penalty—20 penalty units.

- (4) If the driver is turning left or right or making a U-turn, the driver must also give way to any pedestrian at or near the intersection crossing the road, or part of the road, the driver is entering.

Maximum penalty—20 penalty units.

- (5) For this section, an oncoming vehicle proceeding through a T-intersection on the continuing road is taken not to be turning.

Examples—



Example 1
Stop sign

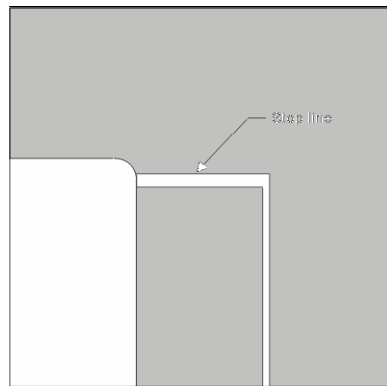

Example 2
Stop line

[s 67]

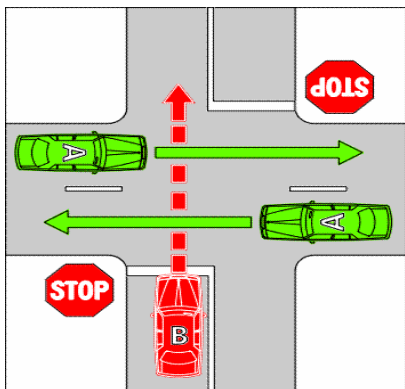

Example 3

Stopping and giving way at a stop sign to vehicles on the left and right

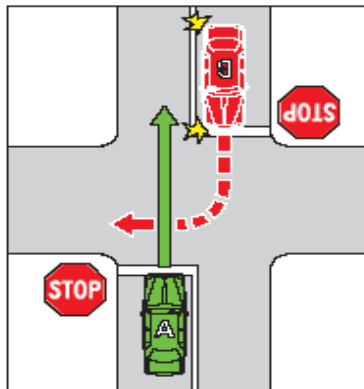

Example 4

Stopping and giving way at a stop sign to an oncoming vehicle at a stop sign

In example 3, vehicle B must stop and give way to each vehicle A.

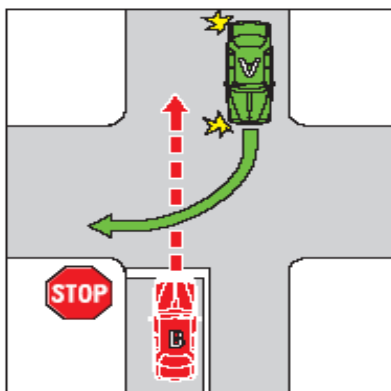

Example 5

Stopping and giving way at a stop sign to an oncoming vehicle that is not at a stop sign or give way sign

In examples 4 and 5, vehicle B must stop and give way to vehicle A.

68 Stopping and giving way at a stop sign or stop line at other places

- (1) This section applies to a driver approaching or at a place with a stop sign or stop line, unless the place is—
- (a) an intersection; or
 - (b) a children’s crossing; or
 - (c) an area of a road that is not a children’s crossing only because it does not have—
 - (i) children crossing flags; or
 - (ii) children’s crossing signs and twin yellow lights; or
 - (d) a level crossing; or
 - (e) a place with twin red lights.

Examples—

- a stop sign at a break in a dividing strip dividing the part of the road used by the main body of moving vehicles from a service road
 - a stop sign on an exit from a carpark where the exit joins the road
- (2) The driver must stop as near as practicable to, but before reaching—
- (a) the stop line; or
 - (b) if there is no stop line—the stop sign.

Maximum penalty—20 penalty units.

- (3) The driver must give way to any vehicle or pedestrian at or near the stop line or stop sign.

Maximum penalty—20 penalty units.

[s 69]

Examples—

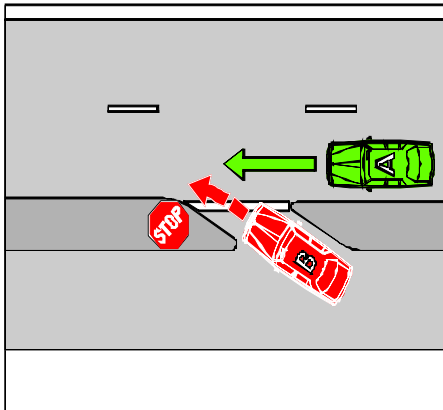

Example 1

Stopping and giving way at a stop sign at a break in a dividing strip

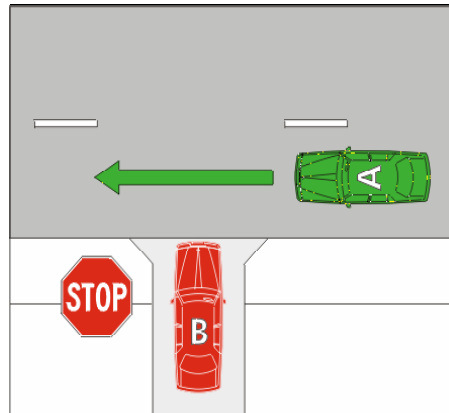

Example 2

Stopping and giving way at a stop sign where a carpark exit joins a road

In each example, vehicle B must stop and give way to vehicle A.

69 Giving way at a give way sign or give way line at an intersection, other than a roundabout

- (1) This section applies to a driver at an intersection, other than a roundabout, who is facing a give way sign or give way line.
- (2) Unless the driver is turning left using a slip lane, the driver must give way to a vehicle in, entering or approaching the intersection except—
 - (a) an oncoming vehicle turning right at the intersection, if a stop sign, stop line, give way sign or give way line applies to the driver of the oncoming vehicle; or
 - (b) a vehicle turning left at the intersection using a slip lane; or
 - (c) a vehicle making a U-turn.

Maximum penalty—20 penalty units.

- (2A) If the driver is turning left using a slip lane, the driver must give way to—
- (a) a vehicle, other than a vehicle making a U-turn at the intersection, that is—
 - (i) on the road that the driver is entering; or
 - (ii) turning right at the intersection into the road that the driver is entering; and
 - (b) a vehicle or a pedestrian on the slip lane.

Maximum penalty—20 penalty units.

- (3) If the driver is turning left or right or making a U-turn, the driver must also give way to any pedestrian at or near the intersection crossing the road, or part of the road, the driver is entering.

Maximum penalty—20 penalty units.

- (5) For this section, an oncoming vehicle proceeding through a T-intersection on the continuing road is taken not to be turning.

Examples—



Example 1
Give way sign

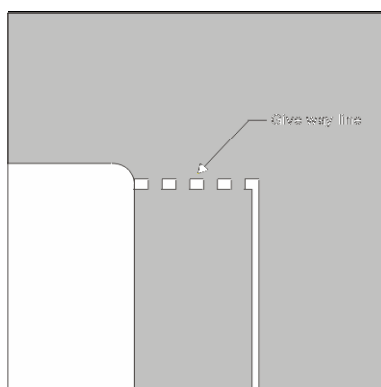

Example 2
Give way line

[s 69]

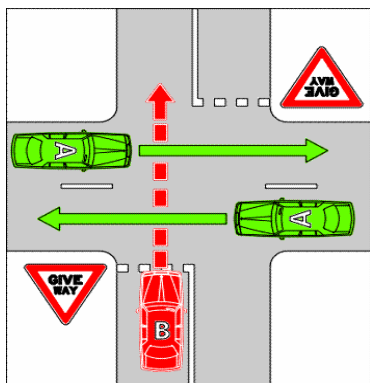

Example 3
Giving way at a give way sign to vehicles on the left and right

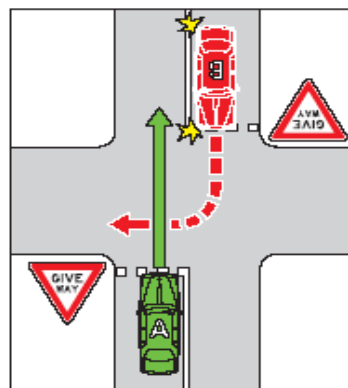

Example 4
Giving way at a give way sign to an oncoming vehicle at a give way sign

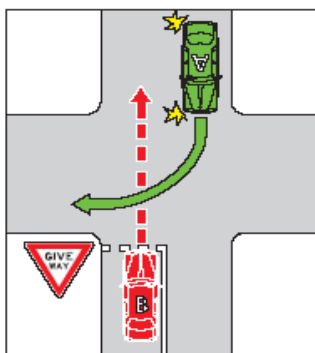

Example 5
Giving way at a give way sign to an oncoming vehicle that is not at a stop sign or give way sign

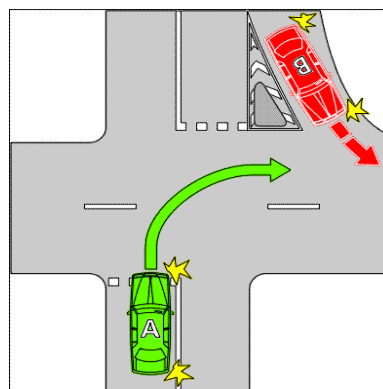

Example 6
Driver turning right at a give way line does not have to give way to a vehicle turning left using a slip lane

In example 3, vehicle B must give way to each vehicle A.

In examples 4, 5 and 6, vehicle B must give way to vehicle A.

69A Two or more drivers facing various signs or lines at an intersection

If 2 or more drivers at an intersection are each facing a stop sign, stop line, give way sign or give way line, each driver must give way to the other or others, as required under division 2, as if none of the drivers were facing a stop sign, stop line, give way sign or give way line.

Maximum penalty—20 penalty units.

70 Giving way at a give way sign at a bridge or length of narrow road

A driver approaching a bridge or length of narrow road with a give way sign must give way to any oncoming vehicle that is on, or approaching, the bridge or length of road when the driver reaches the sign.

Maximum penalty—20 penalty units.

Examples—

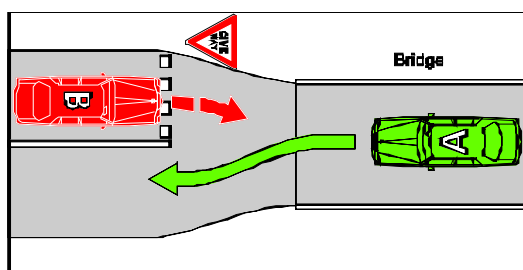

Example 1
Giving way at a bridge

[s 71]

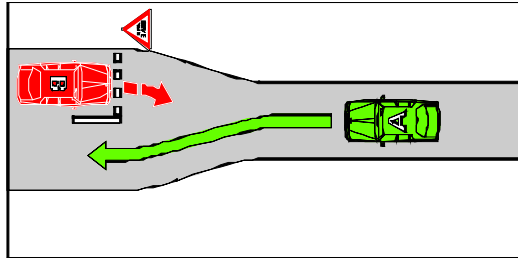

Example 2

Giving way at a length of narrow road

In each example, vehicle B must give way to vehicle A.

71 Giving way at a give way sign or give way line at other places

- (1) A driver approaching or at a place (except an intersection, bridge or length of narrow road, level crossing, or a place with twin red lights) with a give way sign or give way line must give way in accordance with this section.

Maximum penalty—20 penalty units.

Examples—

- a give way sign at a break in a dividing strip dividing the part of the road used by the main body of moving vehicles from a service road
 - a give way sign on a road at a place where a bicycle path meets the road
- (2) The driver must give way to any vehicle or pedestrian at or near the give way sign or give way line.

Examples—

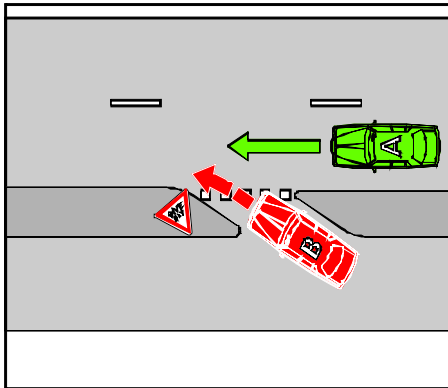

Example 1

Giving way at a give way sign at a break in a dividing strip

In example 1, vehicle B must give way to vehicle A.

In example 2, the motor vehicle must give way to the bicycle.

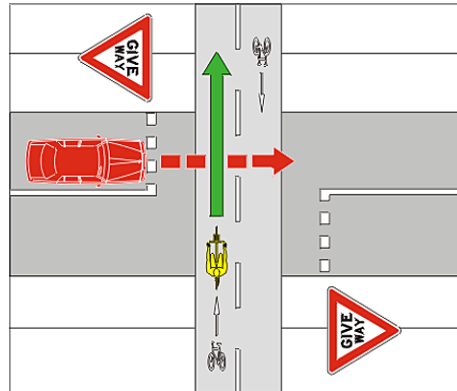

Example 2

Giving way at a give way sign where a bicycle path meets a road

Division 2 Giving way at an intersection without traffic lights or a stop sign, stop line, give way sign or give way line

72 Giving way at an intersection (except a T-intersection or roundabout)

- (1) A driver at an intersection (except a T-intersection or roundabout) who is not facing traffic lights or a stop sign, stop line, give way sign, or give way line, must give way in accordance with this section.

Maximum penalty—20 penalty units.

- (2) If the driver is going straight ahead, the driver must give way to any vehicle approaching from the right (except a vehicle

[s 72]

approaching or at a place with a stop sign, stop line, give way sign, or give way line).

Examples—

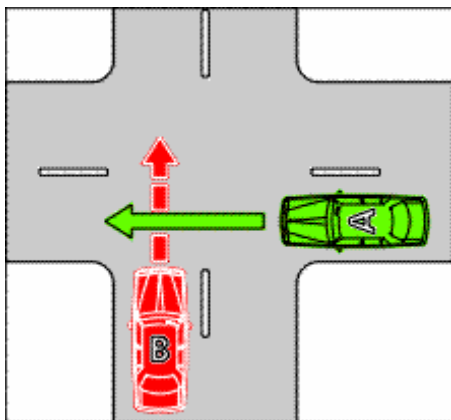

Example 1
Driver going straight ahead giving way to a vehicle on the right that is going straight ahead

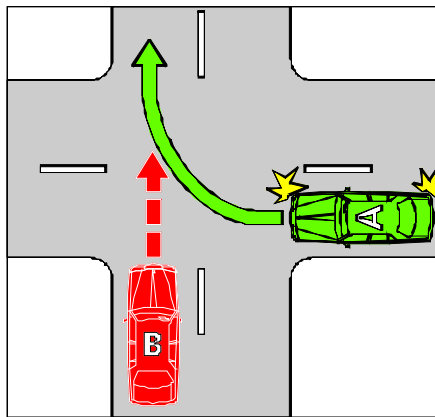

Example 2
Driver going straight ahead giving way to a vehicle on the right that is turning right

In each example, vehicle B must give way to vehicle A.

- (3) If the driver is turning left (except if the driver is using a slip lane), the driver must give way to—
 - (a) any vehicle approaching from the right (except a vehicle approaching or at a place with a stop sign, stop line, give way sign, or give way line); and
 - (b) any pedestrian at or near the intersection crossing the road the driver is entering.

Examples—

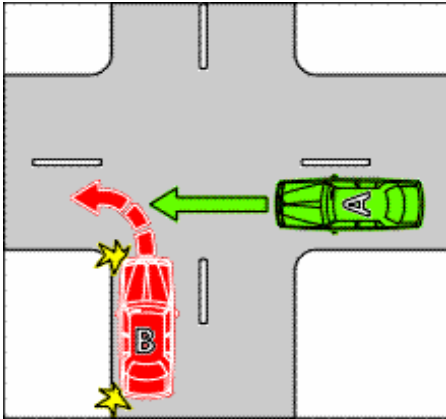

Example 3
Driver turning left giving way to a vehicle on the right that is going straight ahead

In example 3, vehicle B must give way to vehicle A.

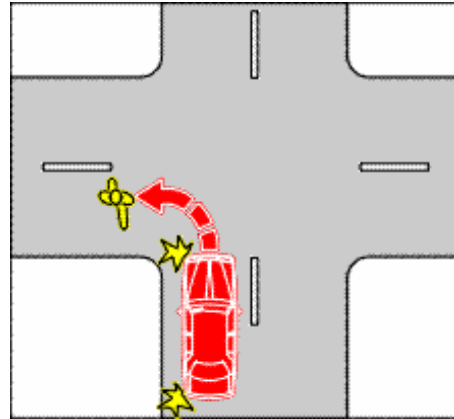

Example 4
Driver turning left giving way to a pedestrian crossing the road the driver is entering

In example 4, the vehicle must give way to the pedestrian.

- (4) If the driver is turning left using a slip lane, the driver must give way to—
- (a) any vehicle approaching from the right or turning right at the intersection into the road the driver is entering (except a vehicle making a U-turn at the intersection); and
 - (b) any pedestrian on the slip lane.

[s 72]

Example—

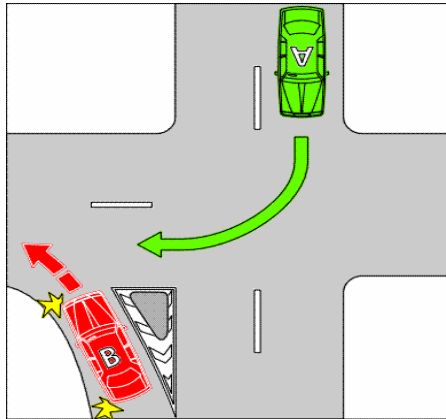

Example 5

Driver turning left using a slip lane giving way to a vehicle that is turning right into the road the driver is entering

In this example, vehicle B must give way to vehicle A.

- (5) If the driver is turning right, the driver must give way to—
- (a) any vehicle approaching from the right (except a vehicle approaching or at a place with a stop sign, stop line, give way sign, or give way line); and
 - (b) any oncoming vehicle that is going straight ahead or turning left at the intersection (except a vehicle turning left using a slip lane or a vehicle approaching or at a place with a stop sign, stop line, give way sign, or give way line); and
 - (c) any pedestrian at or near the intersection crossing the road the driver is entering.

Examples—

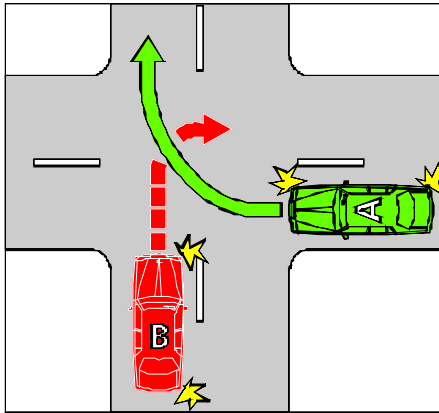

Example 6
Driver turning right giving way to a vehicle on the right that is turning right into the road the driver is leaving

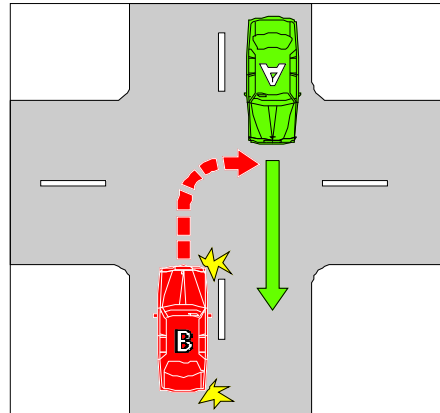

Example 7
Driver turning right giving way to an oncoming vehicle that is going straight ahead on the road the driver is leaving

In examples 6 and 7, vehicle B must give way to vehicle A.

[s 73]

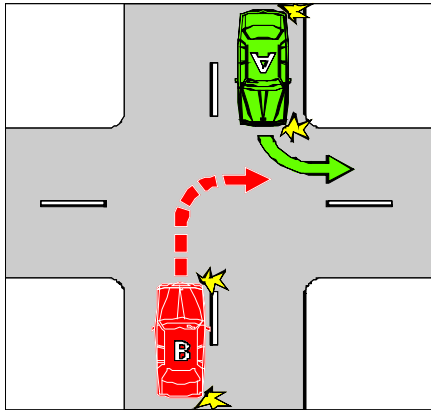

Example 8

Driver turning right giving way to an oncoming vehicle that is turning left into the road the driver is entering

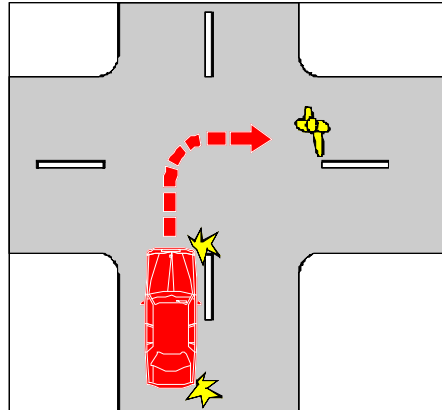

Example 9

Driver turning right giving way to a pedestrian crossing the road the driver is entering

In example 8, vehicle B must give way to vehicle A.

In example 9, the vehicle must give way to the pedestrian.

73 Giving way at a T-intersection

- (1) A driver at a T-intersection who is not facing traffic lights or a stop sign, stop line, give way sign, or give way line, must give way in accordance with this section.

Maximum penalty—20 penalty units.

- (2) If the driver is turning left (except if the driver is using a slip lane) or right from the terminating road into the continuing road, the driver must give way to—
 - (a) any vehicle travelling on the continuing road except—
 - (i) a vehicle approaching or at a place with a stop sign, stop line, give way sign, or give way line; or
 - (ii) a vehicle making a U-turn on the continuing road at the T-intersection; and

- (b) any pedestrian crossing the continuing road at or near the intersection.

Examples—

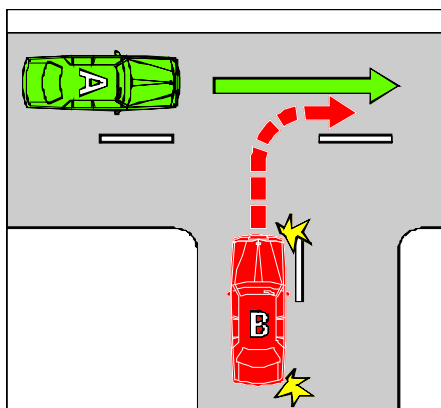

Example 1

Driver turning right from the terminating road giving way to a vehicle on the continuing road

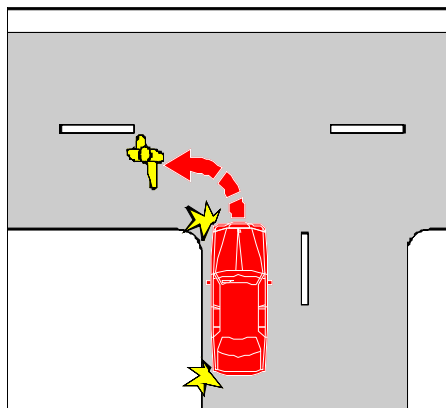

Example 2

Driver turning left (except if the driver is using a slip lane) from the terminating road giving way to a pedestrian crossing the continuing road

In example 1, vehicle B must give way to vehicle A.

In example 2, the vehicle must give way to the pedestrian.

- (3) If the driver is turning left from the terminating road into the continuing road using a slip lane, the driver must give way to—
- (a) any vehicle travelling on the continuing road (except a vehicle making a U-turn on the continuing road at the T-intersection); and
 - (b) any pedestrian on the slip lane.
- (4) If the driver is turning left (except if the driver is using a slip lane) from the continuing road into the terminating road, the driver must give way to any pedestrian crossing the terminating road at or near the intersection.

[s 73]

Example—

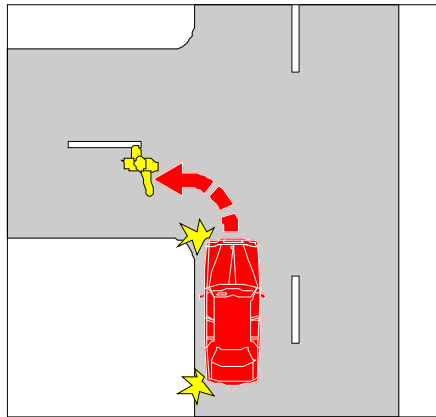

Example 3

Driver turning left (except if the driver is using a slip lane) from the continuing road giving way to a pedestrian crossing the terminating road

In this example, the vehicle must give way to the pedestrian.

- (5) If the driver is turning from the continuing road into the terminating road using a slip lane, the driver must give way to—
 - (a) any vehicle approaching from the right (except a vehicle making a U-turn from the terminating road at the T-intersection); and
 - (b) any pedestrian on the slip lane.
- (6) If the driver is turning right from the continuing road into the terminating road, the driver must give way to—
 - (a) any oncoming vehicle that is travelling through the intersection on the continuing road or turning left at the intersection (except a vehicle approaching or at a place with a stop sign, stop line, give way sign, or give way line); and
 - (b) any pedestrian crossing the terminating road at or near the intersection.

Examples—

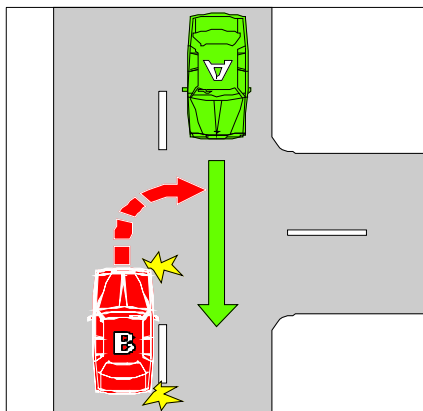

Example 4

Driver turning right from the continuing road giving way to an oncoming vehicle travelling through the intersection on the continuing road

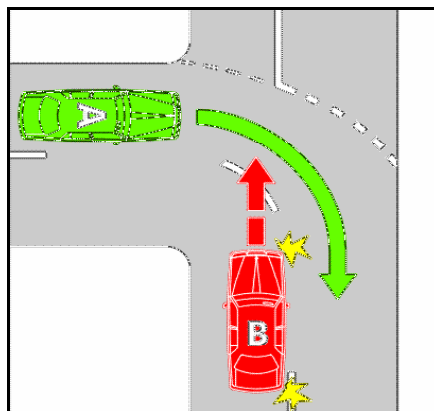

Example 5

Driver leaving the continuing road to go straight ahead on the terminating road giving way to a vehicle going through the intersection on the continuing road

Example 5 shows a T-intersection where the continuing road (marked with broken white lines) goes around a corner. Vehicle B is leaving the continuing road to enter the terminating road. In examples 4 and 5, vehicle B must give way to vehicle A.

[s 73]

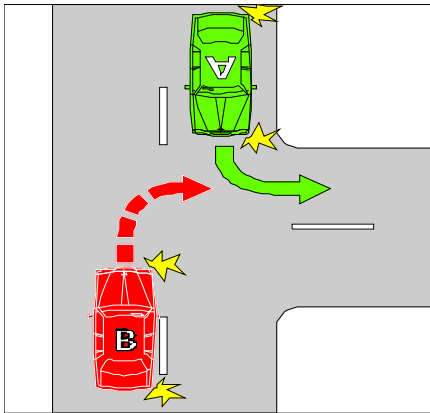

Example 6

Driver turning right from the continuing road giving way to an oncoming vehicle turning left from the continuing road

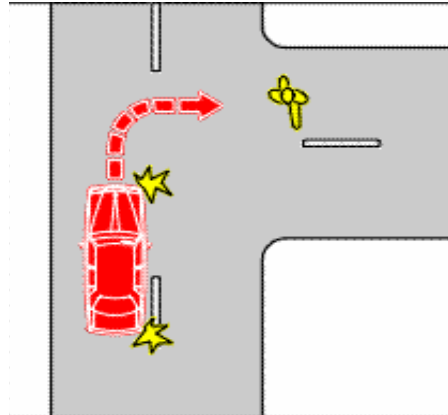

Example 7

Driver turning right from the continuing road giving way to a pedestrian crossing the terminating road

In example 6, vehicle B must give way to vehicle A.

In example 7, the vehicle must give way to the pedestrian.

(7) In this section—

- (a) *turning left from the continuing road into the terminating road*, for a driver, includes, where the continuing road curves to the right at a T-intersection, leaving the continuing road to proceed straight ahead onto the terminating road; and
- (b) *turning right from the continuing road into the terminating road*, for a driver, includes, where the continuing road curves to the left at a T-intersection, leaving the continuing road to proceed straight ahead onto the terminating road.

Division 3 Entering or leaving road-related areas and adjacent land

74 Giving way when entering a road from a road-related area or adjacent land

- (1) A driver entering a road from a road-related area, or adjacent land, without traffic lights or a stop sign, stop line, give way sign or give way line must give way to all of the following—
- (a) a vehicle travelling on the road or turning into the road, except a vehicle turning right into the road from a road-related area or adjacent land;
 - (b) a pedestrian on the road;
 - (c) a vehicle or a pedestrian on a road-related area that the driver crosses to enter the road;
 - (d) for a driver entering the road from a road-related area—
 - (i) a pedestrian on the road-related area; and
 - (ii) another vehicle ahead of the driver's vehicle or approaching from the left or right.

Maximum penalty—20 penalty units.

- (2) In this section—
road does not include a road-related area.

[s 75]

Example—

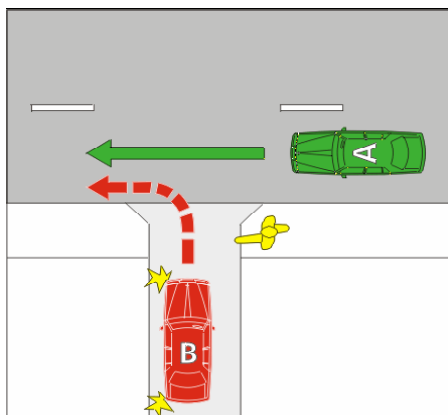

Driver entering a road from a road-related area giving way to a pedestrian on the footpath and a vehicle on the road

In this example, vehicle B must give way to the pedestrian on the footpath and to vehicle A.

75 Giving way when entering a road-related area or adjacent land from a road

- (1) A driver entering a road-related area or adjacent land from a place on a road without traffic lights or a stop sign, stop line, give way sign or give way line must give way to—
 - (a) any pedestrian on the road; and
 - (b) any vehicle or pedestrian on any road-related area that the driver crosses or enters; and
 - (c) if the driver is turning right from the road—any oncoming vehicle on the road that is going straight ahead or turning left; and
 - (d) if the road the driver is leaving ends at a T-intersection opposite the road-related area or adjacent land and the driver is crossing the continuing road—any vehicle on the continuing road.

Maximum penalty—20 penalty units.

- (2) In this section—
road does not include a road-related area.

Examples—

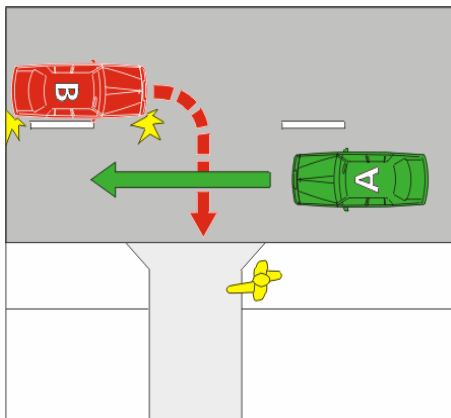

Example 1

Driver turning right from a road into a road-related area giving way to an oncoming vehicle that is going straight ahead and to a pedestrian on the footpath

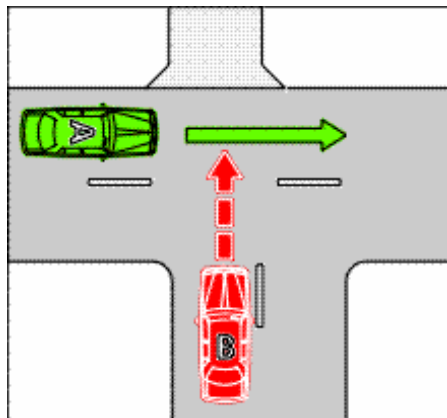

Example 2

Driver crossing a continuing road at a T-intersection to enter a road-related area giving way to a vehicle on the continuing road

In each example, vehicle B must give way to vehicle A. In example 1, vehicle B must also give way to the pedestrian on the footpath.

Division 4 Keeping clear of and giving way to particular vehicles

76 Keeping clear of trams travelling in tram lanes etc.

- (1) A driver must not move into the path of an approaching tram travelling in a tram lane, or on tram tracks marked along the left side of the tracks by a broken or continuous yellow line parallel to the tracks.

Maximum penalty—20 penalty units.

[s 77]

- (2) If a driver is in the path of an approaching tram travelling in a tram lane, or on tram tracks marked along the left side of the tracks by a broken or continuous yellow line parallel to the tracks, the driver must move out of the path of the tram as soon as the driver can do so safely.

Maximum penalty—20 penalty units.

- (3) In this section—

tram includes a bus travelling along tram tracks.

77 Giving way to buses

- (1) A driver driving on a length of road in a built-up area where the speed limit applying to the driver is not more than 70km/h, in the left lane or left line of traffic, or in a bicycle lane on the far left side of the road, must give way to a bus in front of the driver if—

- (a) the bus has stopped, or is moving slowly, at the far left side of the road or in a bus-stop bay; and
- (b) the bus displays a give way to buses sign and the right direction indicator lights of the bus are operating; and
- (c) the bus is about to enter or proceed in the lane or line of traffic in which the driver is driving.

Maximum penalty—20 penalty units.

- (2) In this section—

left lane, of a road, means—

- (a) the marked lane nearest to the far left side of the road (the *first lane*) or, if the first lane is a bicycle lane, the marked lane next to the first lane; or
- (b) if there is an obstruction in the first lane (for example, a parked car or roadworks) and the first lane is not a bicycle lane—the marked lane next to the first lane.

left line of traffic, for a road, means the line of traffic nearest to the far left side of the road.

Example—



Give way to buses sign

78 Keeping clear of police and emergency vehicles

- (1) A driver must not move into the path of an approaching police or emergency vehicle that is displaying a flashing blue or red light (whether or not it is also displaying other lights) or sounding an alarm.

Maximum penalty—20 penalty units.

- (2) If a driver is in the path of an approaching police or emergency vehicle that is displaying a flashing blue or red light (whether or not it is also displaying other lights) or sounding an alarm, the driver must move out of the path of the vehicle as soon as the driver can do so safely.

Maximum penalty—20 penalty units.

- (3) This section applies to the driver despite any other section of this regulation.

79 Giving way to police and emergency vehicles

- (1) A driver must give way to a police or emergency vehicle that is displaying a flashing blue or red light (whether or not it is also displaying other lights) or sounding an alarm.

Maximum penalty—20 penalty units.

- (2) This section applies to the driver despite any other section that would otherwise require the driver of a police or emergency vehicle to give way to the driver.

[s 79A]

79A Giving way to escorted vehicles

- (1) A driver must give way to an oversize vehicle that is being escorted by a pilot or escort vehicle.

Maximum penalty—20 penalty units.

- (2) This section applies to the driver despite any other section that would otherwise require the driver of an oversize vehicle to give way to the driver.

Division 5 Crossings and shared zones

80 Stopping at a children's crossing

- (1) A driver approaching a children's crossing must drive at a speed at which the driver can, if necessary, stop safely before the crossing.

Maximum penalty—20 penalty units.

- (2) A driver approaching or at a children's crossing must stop as near as practicable to, but before reaching, the stop line at the crossing if—
 - (a) a hand-held stop sign is displayed at the crossing; or
 - (b) a pedestrian or rider of a bicycle is on or entering the crossing.

Maximum penalty—20 penalty units.

- (3) If a driver stops at a children's crossing for a hand-held stop sign, the driver must not proceed until—
 - (a) there is no pedestrian, or rider of a bicycle, on or entering the crossing; and
 - (b) the holder of the sign—
 - (i) no longer displays the sign towards the driver; or
 - (ii) otherwise indicates that the driver may proceed.

Maximum penalty—20 penalty units.

- (4) If a driver stops at a children's crossing for a pedestrian or rider of a bicycle, the driver must not proceed until there is no pedestrian, or rider of a bicycle, on or entering the crossing.

Maximum penalty—20 penalty units.

- (5) For this section, if a children's crossing extends across a road with a dividing strip, the part of the children's crossing on each side of the dividing strip is taken to be a separate children's crossing.

- (6) A *children's crossing* is an area of a road—

- (a) at a place with stop lines marked on the road, and—

- (i) children crossing flags; or
(ii) children's crossing signs and twin yellow lights;
and

- (b) indicated by—

- (i) 2 red and white posts erected on each side of the road; or
(ii) 2 parallel continuous or broken lines on the road surface from 1 side of the road completely or partly across the road; and

- (c) extending across the road between the posts or lines.

[s 80]

Examples—



Children crossing flag



Children's crossing sign



Hand-held stop signs



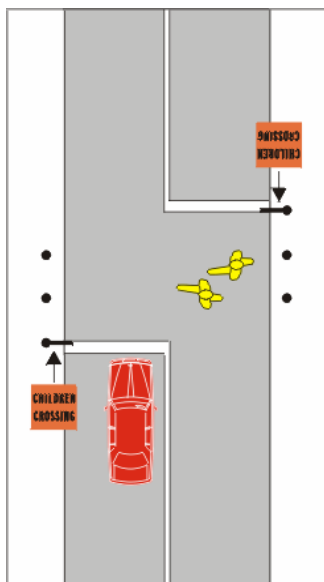

Example 1

Driver stopped at stop line for pedestrians on a children's crossing with children crossing flags

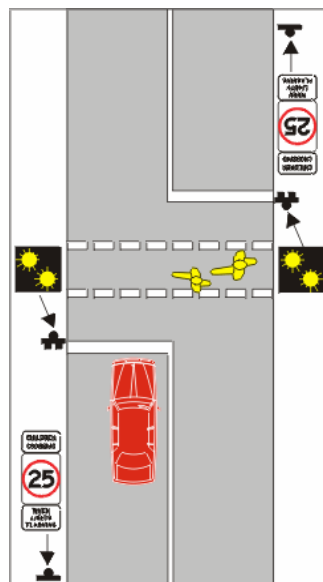

Example 2

Driver stopped at stop line for pedestrians on a children's crossing with children's crossing signs and twin yellow lights

In each of these examples, the driver must stop at the stop line because there are pedestrians on the children's crossing.

81 Giving way at a pedestrian crossing

- (1) A driver approaching a pedestrian crossing must drive at a speed at which the driver can, if necessary, stop safely before the crossing.

Maximum penalty—20 penalty units.

- (2) A driver must give way to any pedestrian or rider of a bicycle on a pedestrian crossing.

Maximum penalty—20 penalty units.

- (3) A *pedestrian crossing* is an area of a road—

- (a) at a place with white stripes on the road surface that—

[s 81]

- (i) run lengthwise along the road; and
 - (ii) are of approximately the same length; and
 - (iii) are approximately parallel to each other; and
 - (iv) are in a row that extends completely, or partly, across the road; and
- (b) with or without either or both of the following—
- (i) a pedestrian crossing sign;
 - (ii) alternating flashing twin yellow lights.

Examples—



Pedestrian crossing sign

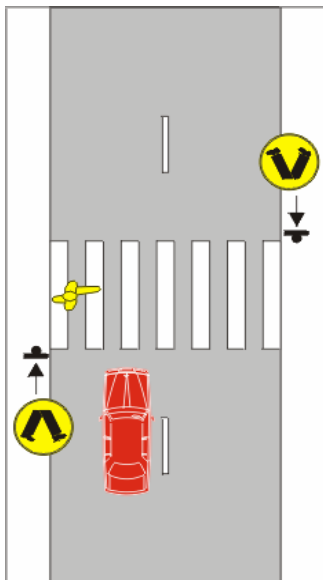

Example 1
Giving way to a pedestrian on a pedestrian crossing

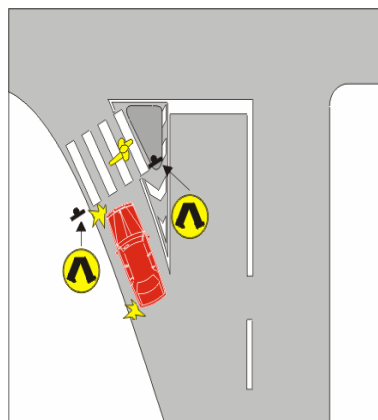

Example 2
Giving way to a pedestrian on a pedestrian crossing at a slip lane

In each of these examples, the driver must give way to the pedestrian on the crossing.

82 Overtaking or passing a vehicle at a children's crossing or pedestrian crossing

A driver approaching a children's crossing, or pedestrian crossing, must not overtake or pass a vehicle that is travelling in the same direction as the driver and is stopping, or has stopped, to give way to a pedestrian or rider of a bicycle at the crossing.

Maximum penalty—20 penalty units.

[s 83]

Example—

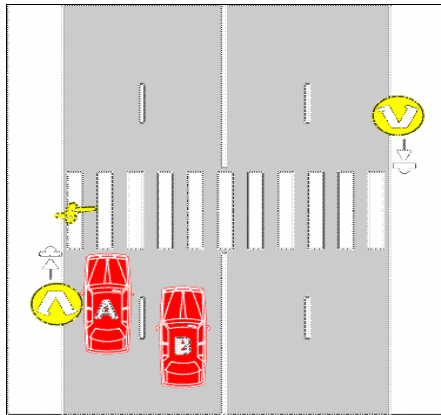

Driver not passing a vehicle that has stopped to give way to a pedestrian at a pedestrian crossing

In the example, vehicle A has stopped to give way to a pedestrian on the crossing. Vehicle B must not overtake or pass vehicle A.

83 Giving way to pedestrians in a shared zone

A driver driving in a shared zone must give way to any pedestrian in the zone.

Maximum penalty—20 penalty units.

Division 6 Other give way rules

84 Giving way when driving through a break in a dividing strip

- (1) If a driver drives through a break in a dividing strip that has no stop sign, stop line, give way sign or give way line, the driver must give way to—
 - (a) any tram on the dividing strip; and

- (b) any vehicle travelling on the part of the road the driver is entering (except a vehicle to which a stop sign, stop line, give way sign, or give way line, applies).

Maximum penalty—20 penalty units.

- (2) In this section—

tram includes a bus travelling along tram tracks.

Examples—

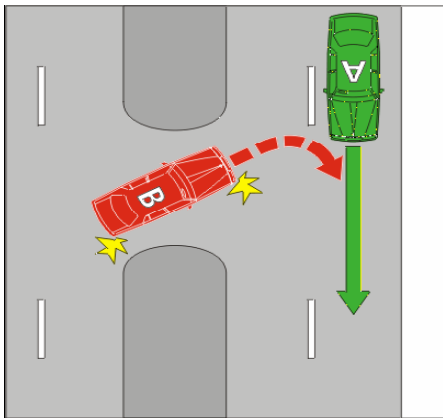

Example 1

Giving way when driving through a break in a median strip

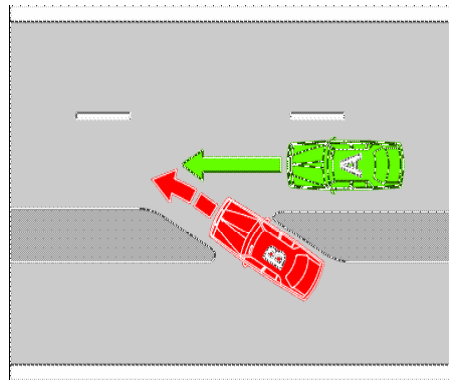

Example 2

Giving way when driving through a break in a dividing strip to leave a service road

[s 85]

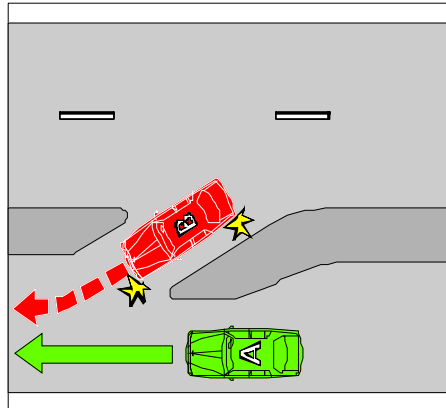

Example 3

Giving way when driving through a break in a dividing strip to enter a service road

In each of the examples, vehicle B must give way to vehicle A.

85 Giving way on a painted island

A driver entering a turning lane from a painted island must give way to any vehicle—

- (a) in the turning lane; or
- (b) entering the turning lane from the marked lane, or line of traffic, immediately adjacent to the turning lane.

Maximum penalty—20 penalty units.

Examples—

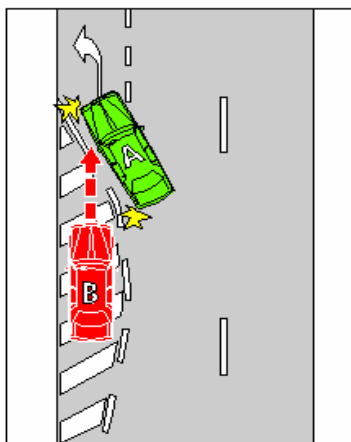

Example 1

Driver entering a turning lane from a painted island giving way to a vehicle entering the turning lane from the marked lane immediately to the right of the turning lane

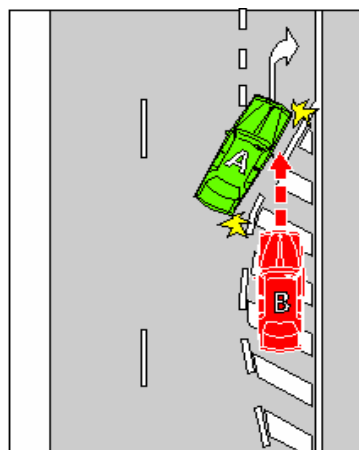

Example 2

Driver entering a turning lane from a painted island giving way to a vehicle entering the turning lane from the marked lane immediately to the left of the turning lane

In the examples, vehicle B must give way to vehicle A.

86 Giving way in median turning bays

- (1) A driver entering a median turning bay must give way to any oncoming vehicle already in the turning bay.

Maximum penalty—20 penalty units.

- (2) In this section—

median turning bay means a marked lane, or the part of a marked lane—

- (a) to which a median turning lane sign applies; or
- (b) where traffic lane arrows applying to the lane indicate that vehicles travelling in opposite directions must turn right.

[s 87]

Examples—



Example 1

Median turning lane sign

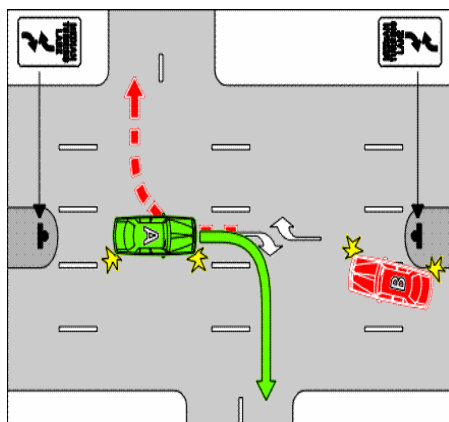

Example 2

Giving way in a median turning bay

In example 2, vehicle B must give way to vehicle A.

87 Giving way when moving from a side of a road or a median strip parking area

- (1) A driver entering a marked lane, or a line of traffic, from the far left or right side of a road must give way to any vehicle travelling in the lane or line of traffic.

Maximum penalty—20 penalty units.

- (2) However, the driver of a bus does not have to give way to a vehicle if—
 - (a) the driver of the vehicle is required to give way to the bus under section 77; and
 - (b) it is safe for the bus to enter the lane or line of traffic in which the vehicle is driving.

- (3) A driver turning from a median strip parking area into a marked lane, or a line of traffic, must give way to any vehicle travelling in the lane or line of traffic.

Maximum penalty—20 penalty units.

(4) In this section—

road does not include a road-related area, but includes any shoulder of the road.

Part 8 Traffic signs and road markings

Division 1 Traffic signs and road markings at intersections and other places

88 Left turn signs

(1) If there is a left turn only sign at an intersection, a driver must turn left at the intersection.

Maximum penalty—20 penalty units.

(2) If there is a left lane must turn left sign at an intersection, a driver who is in the left marked lane when entering the intersection must turn left at the intersection.

Maximum penalty—20 penalty units.

Examples—



Left turn only sign



Left lane must turn left sign

[s 89]

89 Right turn signs

- (1) If there is a right turn only sign at an intersection, a driver must turn right at the intersection.

Maximum penalty—20 penalty units.

- (2) If there is a right lane must turn right sign at an intersection, a driver who is in the right marked lane when entering the intersection must turn right at the intersection.

Maximum penalty—20 penalty units.

- (3) In this section—

turn right does not include make a U-turn.

Examples—



Right turn only sign



Right lane must turn right sign

90 No turns signs

If there is a no turns sign at an intersection, a driver must not turn left or right, or make a U-turn, at the intersection.

Maximum penalty—20 penalty units.

Example—



No turns sign

91 No left turn and no right turn signs

- (1) If there is a no left turn sign at an intersection, or another place on a road, a driver must not turn left at the intersection or place.

Maximum penalty—20 penalty units.

- (2) If there is a no right turn sign at an intersection, or another place on a road, a driver must not turn right or make a U-turn at the intersection or place.

Maximum penalty—20 penalty units.

Examples of no left turn signs—



No left turn sign (Standard sign)



No left turn sign (Variable illuminated message sign)

[s 92]

Examples of no right turn signs—



No right turn sign (Standard sign)



No right turn sign (Variable illuminated message sign)

- (3) However, a driver may make a U-turn at the intersection or place if there is a U-turn permitted sign at the intersection or place.

92 Traffic lane arrows

- (1) If a driver is driving in a marked lane at an intersection (except a roundabout) and there are traffic lane arrows applying to the lane, the driver must—
- (a) if the arrows indicate a single direction—drive in that direction; or
 - (b) if the arrows indicate 2 or more directions—drive in 1 of those directions.

Maximum penalty—20 penalty units.

- (2) However, this section does not apply to a driver if—
- (a) the arrows indicate a direction to the right (whether or not they also indicate another direction) at an intersection and the driver is making a U-turn at the intersection; or
 - (b) a traffic sign indicates that the driver may drive in a direction different to that indicated by the traffic lane arrows; or
 - (c) the driver is driving in the direction indicated by traffic lane arrows that apply to 1 or more marked lanes and there is an obstruction in each of those lanes; or

- (d) the driver is turning at an intersection in accordance with section 28(2) or 32(2).

Examples—

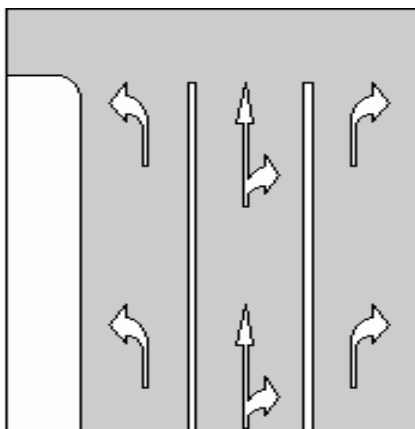

Example 1

Traffic lane arrows on the surface of marked lanes

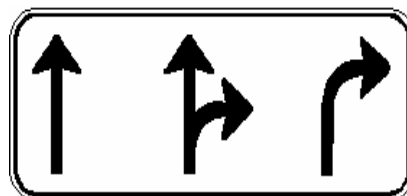

Example 2

Traffic lane arrows on a traffic sign

- (3) The existence of a bicycle storage area in a marked lane does not alter a driver's obligation to comply with this section.

Division 2 Traffic signs and road markings generally

93 No overtaking or passing signs

- (1) A driver must not—
- (a) drive past a no overtaking or passing sign if any oncoming vehicle is on the bridge or length of road to which the sign applies; or
 - (b) overtake a vehicle on a bridge or length of road to which a no overtaking or passing sign applies.

Maximum penalty—20 penalty units.

[s 94]

- (2) A no overtaking or passing sign on a road applies to the length of road (including a length of road on a bridge) beginning at the sign and ending—
- (a) if information on or with the sign indicates a distance—at that distance past the sign; or
 - (b) if the sign applies to a bridge—at the end of the bridge; or
 - (c) at an end no overtaking or passing sign on the road.

Examples—



No overtaking or passing sign

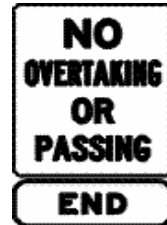

End no overtaking or passing sign

94 No overtaking on bridge signs

A driver on a bridge with a no overtaking on bridge sign must not overtake a vehicle between the sign and the far end of the bridge.

Maximum penalty—20 penalty units.

Example—



No overtaking on bridge sign

95 Emergency stopping lane only signs

- (1) A driver must not drive in an emergency stopping lane unless—
 - (a) the driver needs to drive in the emergency stopping lane to avoid a collision, to stop in the lane, or because the driver's vehicle is disabled; or
 - (b) the driver is permitted to drive in the emergency stopping lane under another section.

Maximum penalty—20 penalty units.

- (2) This section does not apply to the rider of a bicycle.
- (3) In this regulation—

emergency stopping lane means a marked lane, or the part of a marked lane, to which an emergency stopping lane only sign applies.

[s 96]

Example—



Emergency stopping lane only sign

96 Keep clear markings

- (1) A driver must not stop on an area of a road marked with a keep clear marking.

Maximum penalty—20 penalty units.

- (2) In this section—

keep clear marking means the words ‘keep clear’ marked across all or part of a road, with or without continuous lines marked across all or part of the road.

Examples—

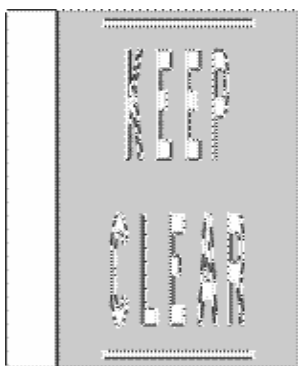

Keep clear marking bounded by line road markings

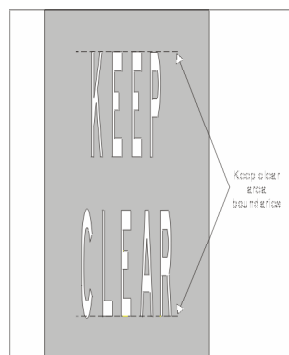

Keep clear marking with no line road markings

97 Road access signs

- (1) A driver must not drive on a length of road to which a road access sign applies if information on or with the sign indicates that the driver or the driver's vehicle is not permitted beyond the sign.

Maximum penalty—20 penalty units.

- (2) A road access sign on a road applies to the length of road beginning at the sign (including any road into which the length of road merges) and ending—
- (a) if the sign is on a freeway—at an end freeway sign or end road access sign on the road; or
 - (b) if the sign is not on a freeway—at the nearer of the following—
 - (i) if the road ends at a T-intersection or dead end—the end of the road;
 - (ii) an end road access sign on the road.

[s 98]

Examples—

A road access sign on an access ramp to a freeway applies to the access ramp and the freeway into which the access ramp merges.



Road access sign



End freeway sign



End road access sign

98 One-way signs

- (1) A driver must not drive on a length of road to which a one-way sign applies except in the direction indicated by the arrow on the sign.

Maximum penalty—20 penalty units.

- (2) A one-way sign on a road applies to the length of road beginning at the sign and ending at the nearer of the following—
 - (a) a two-way sign on the road;
 - (b) a keep left sign on the road;

- (c) another sign or road marking on the road that indicates that the road is a two-way road;
 - (d) if the road ends at a T-intersection—the end of the road.
- (3) This section does not apply to the rider of a motorbike that is a postal vehicle, the rider of a bicycle or the rider of an animal if the rider—
- (a) is riding on a footpath, nature strip or shared path adjacent to the length of road; and
 - (b) is permitted to ride on the footpath, nature strip or shared path under this regulation.

Examples—



One-way sign

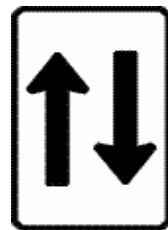

Two-way sign

99 Keep left and keep right signs

- (1) A driver driving past a keep left sign must drive to the left of the sign.
Maximum penalty—20 penalty units.
- (2) A driver driving past a keep right sign must drive to the right of the sign.
Maximum penalty—20 penalty units.
- (3) This section does not apply to the rider of a motorbike that is a postal vehicle, the rider of a bicycle or the rider of an animal if the rider—
 - (a) is riding on a footpath, nature strip or shared path; and

[s 100]

- (b) is permitted to ride on the footpath, nature strip or shared path under this regulation.

Examples—



Keep left sign



Keep right sign

100 No entry signs

A driver must not drive past a no entry sign.

Maximum penalty—20 penalty units.

Example—



No entry sign

101 Hand-held stop signs

- (1) A driver approaching a hand-held stop sign must stop before reaching the sign.

Maximum penalty—20 penalty units.

- (2) The driver must not proceed until the holder of the sign—
(a) no longer displays the sign towards the driver; or

(b) otherwise indicates that the driver may proceed.

Maximum penalty—20 penalty units.

- (3) This section does not apply to a driver approaching or at a hand-held stop sign at a children's crossing.

Examples of hand-held stop signs—



101A Safety ramp and arrester bed signs

- (1) A driver must not drive on a safety ramp or arrester bed unless it is necessary for the driver to do so in the interests of safety.

Maximum penalty—20 penalty units.

- (2) In this section—

arrester bed means an area to which an arrester bed sign applies.

safety ramp means an area to which a safety ramp sign applies.

Examples—



Arrester bed sign



Safety ramp sign

[s 102]

Division 3 Signs for trucks, buses and other large vehicles

102 Clearance and low clearance signs

- (1) A driver must not drive past a clearance sign, or a low clearance sign, if the driver's vehicle, or any vehicle connected to it, is higher than the height (in metres) indicated by the sign.

Maximum penalty—40 penalty units.

- (2) In this section—

vehicle includes any load carried by the vehicle.

Examples—



Clearance sign



Low clearance sign

103 Load limit signs

- (1) A driver must not drive past a bridge load limit (gross mass) sign or gross load limit sign if the total of the gross mass (in tonnes) of the driver's vehicle, and any vehicle connected to it, is more than the gross mass indicated by the sign.

Maximum penalty—20 penalty units.

- (2) A driver must not drive past a bridge load limit (mass per axle group) sign if the mass (in tonnes) carried by an axle group of the driver's vehicle, or any vehicle connected to it, is more than the mass indicated by the sign for the axle group.

Maximum penalty—20 penalty units.

- (3) In this section—
vehicle includes any load carried by the vehicle.

Examples—



Bridge load limit (gross mass) sign



Gross load limit sign

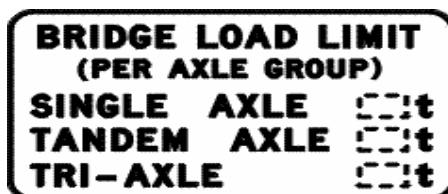

Bridge load limit (mass per axle group) sign

104 No trucks signs

- (1) A driver (except the driver of a bus) must not drive past a no trucks sign that has information on or with it indicating a mass if the GVM of the driver's vehicle (or, if the driver is driving a combination, any vehicle in the combination) is more than that mass.

Maximum penalty—20 penalty units.

- (2) A driver (except the driver of a bus) must not drive past a no trucks sign that has information on or with it indicating a length if the length of the driver's vehicle (or, if the driver is driving a combination, the length of the combination) is longer than that length.

[s 104]

Maximum penalty—20 penalty units.

- (3) The driver of a truck must not drive past a no trucks sign that has no information on or with it indicating a mass or length.

Maximum penalty—20 penalty units.

- (4) It is a defence to a charge under subsection (1), (2) or (3) for the driver to prove—

(a) the destination of the driver's vehicle was on or near the road on which the no trucks sign was located; and

(b) the driver—

(i) could not reach the vehicle's destination by another route; or

(ii) could reach the vehicle's destination by another route only by driving past another no trucks sign.

- (5) Subsections (1) to (3) do not apply to a driver of a motorised caravan on the Brisbane Urban Corridor or on the part of the Ipswich Motorway between Granard Road and the Albert Street pedestrian bridge at Goodna.

- (6) In this section—

Brisbane Urban Corridor means the route between Archerfield and Wishart consisting of Mt Gravatt–Capalaba Road west of the Gateway Motorway, Kessels Road, Riawena Road and Granard Road.

motorised caravan means—

(a) 1 vehicle with a GVM over 4.5t, designed mainly for people to live in; or

(b) a combination of 2 vehicles with a GVM over 4.5t if 1 of the vehicles is designed mainly for people to live in and the other has a GVM of less than 4.5t.

Example of a no trucks sign—

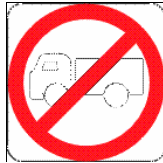

No trucks sign

105 Trucks must enter signs

If the driver of a truck drives past a trucks must enter sign, the driver must enter the area indicated by information on or with the sign.

Maximum penalty—20 penalty units.

Example—



Trucks must enter sign

106 No buses signs

- (1) The driver of a bus must not drive past a no buses sign that has information on or with it indicating a mass if the GVM of the bus is more than that mass.

Maximum penalty—20 penalty units.

[s 107]

- (2) The driver of a bus must not drive past a no buses sign that has information on or with it indicating a length if the bus is longer than that length.

Maximum penalty—20 penalty units.

- (3) The driver of a bus must not drive past a no buses sign that has no information on or with it indicating a mass or length.

Maximum penalty—20 penalty units.

Example—

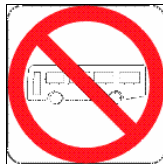

No buses sign

107 Buses must enter signs

If the driver of a bus drives past a buses must enter sign, the driver must enter the area indicated by information on or with the sign.

Maximum penalty—20 penalty units.

Example—



Buses must enter sign

108 Trucks and buses low gear signs

- (1) If the driver of a truck or bus is driving on a length of road to which a trucks and buses low gear sign applies, the driver must drive the truck or bus in a gear that is low enough to limit the speed of the truck or bus without the use of a primary brake.

Maximum penalty—20 penalty units.

- (2) Subsection (1) does not apply to the driver of a bus if information on or with the sign indicates that it applies only to trucks.
- (3) A trucks and buses low gear sign on a road applies to the length of road beginning at the sign and ending—
 - (a) if information on or with the sign indicates a distance—at that distance on the road from the sign; or
 - (b) in any other case—at an end trucks and buses low gear sign on the road.
- (4) In this section—

primary brake means the footbrake, or other brake, fitted to a truck or bus that is normally used to slow or stop the vehicle.

Examples—



Trucks and buses low gear sign



End trucks and buses low gear sign

[s 109]

Part 9 Roundabouts

109 What is a *roundabout*

A *roundabout* is an intersection—

- (a) with either—
 - (i) 1 or more marked lanes, all of which are for the use of vehicles travelling in the same direction around a central traffic island; or
 - (ii) room for 1 or more lines of traffic travelling in the same direction around a central traffic island; and
- (b) with or without a roundabout sign at each entrance.

Example—



Roundabout sign

110 Meaning of *halfway around a roundabout*

A driver leaves a roundabout *halfway around* the roundabout if the driver leaves the roundabout on a road that is straight ahead, or substantially straight ahead, from the road on which the driver enters the roundabout.

111 Entering a roundabout from a multi-lane road or a road with 2 or more lines of traffic travelling in the same direction

- (1) A driver entering a roundabout from a multi-lane road, or a road with room for 2 or more lines of traffic, other than animals, bicycles, motorbikes or motorised wheelchairs,

travelling in the same direction as the driver, must enter the roundabout in accordance with this section.

Maximum penalty—20 penalty units.

- (2) If the driver is to leave the roundabout less than halfway around it, the driver must enter the roundabout—
 - (a) from the left marked lane; or
 - (b) if the road is not a multi-lane road—as near as practicable to the left side of the road.

Example—

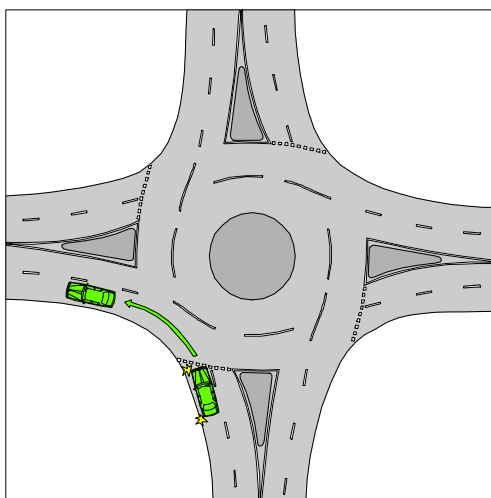

Example 1

Leaving a roundabout less than halfway around it

- (3) If the driver is to leave the roundabout more than halfway around it, the driver must enter the roundabout from—
 - (a) the right marked lane; or
 - (b) if the road is not a multi-lane road—the left of, parallel to, and as near as practicable to, the dividing line or median strip of the road.

[s 111]

Example—

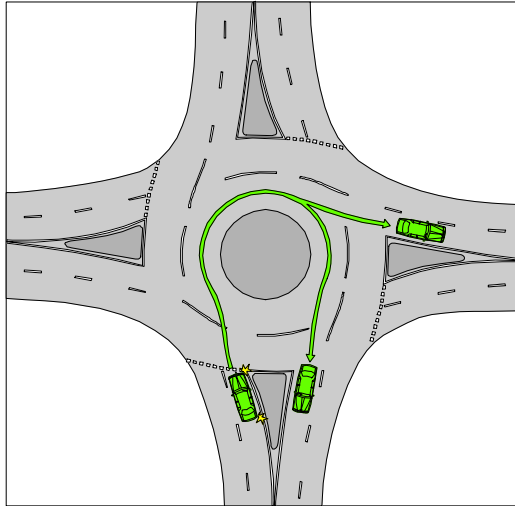

Example 2

Leaving a roundabout more than halfway around it

- (4) If the driver is to leave the roundabout halfway around it, the driver may enter the roundabout from—
 - (a) any marked lane; or
 - (b) if the road is not a multi-lane road—any part of the road on which vehicles travelling in the same direction as the driver may travel.

Example—

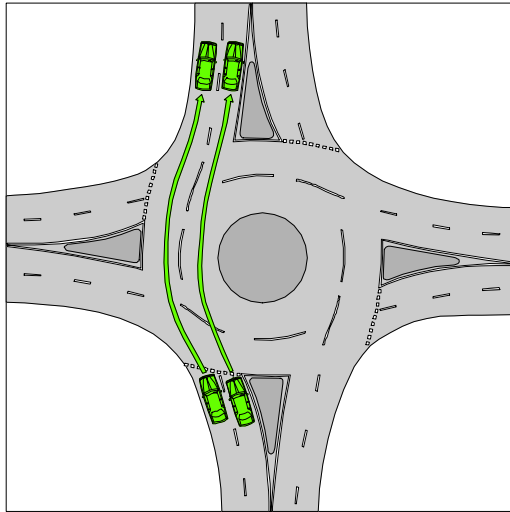

Example 3

Leaving a roundabout halfway around it

- (5) Despite subsections (2) to (4), if the driver is entering the roundabout from a marked lane and there are traffic lane arrows applying to the lane, the driver must—
- (a) if the arrows indicate a single direction—drive in that direction after entering the roundabout; or
 - (b) if the arrows indicate 2 or more directions—drive in 1 of those directions after entering the roundabout.

[s 111]

Examples—

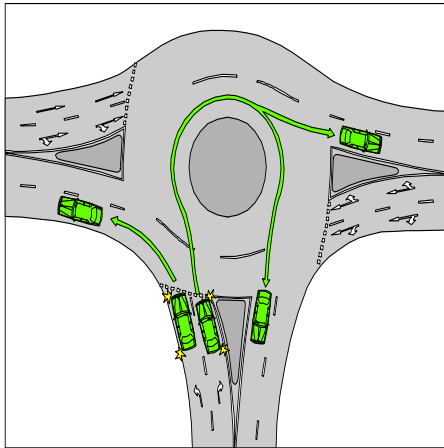

Example 4
Roundabout with 3 entry points

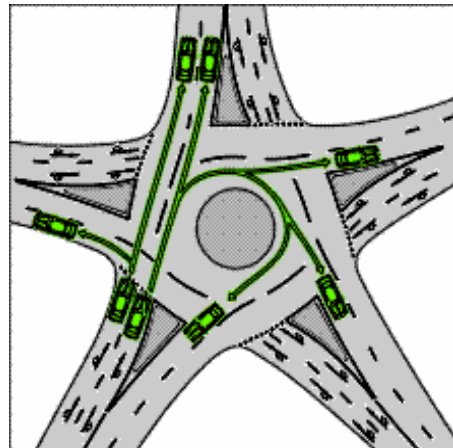

Example 5
Roundabout with 5 entry points

- (5A) Subsection (2)(b) does not apply to the rider of a bicycle.
- (6) Subsection (3) does not apply to the rider of a bicycle or animal.
- (7) Subsection (5) does not apply to the rider of a bicycle or an animal if the rider is to leave the roundabout more than halfway around it.
- (8) Despite subsection (2), a driver may approach and enter the roundabout from the marked lane next to the left lane as well as, or instead of, the left lane if—
 - (a) the driver's vehicle, together with any load or projection, is at least 7.5m long; and
 - (b) the vehicle displays a do not overtake turning vehicle sign; and
 - (c) any part of the vehicle is within 50m of the nearest point of the roundabout; and
 - (d) it is not practicable for the driver to leave the roundabout less than halfway around it from within the left lane; and

-
- (e) the driver can safely occupy the next marked lane and can safely leave the roundabout less than halfway around it by occupying the next marked lane or both lanes.
- (9) Despite subsection (3), a driver may approach and enter the roundabout from the marked lane next to the right lane as well as, or instead of, the right lane if—
- (a) the driver's vehicle, together with any load or projection, is at least 7.5m long; and
 - (b) the vehicle displays a do not overtake turning vehicle sign; and
 - (c) any part of the vehicle is within 50m of the nearest point of the roundabout; and
 - (d) it is not practicable for the driver to leave the roundabout more than halfway around it from within the right lane; and
 - (e) the driver can safely occupy the next marked lane and can safely leave the roundabout more than halfway around it by occupying the next marked lane or both lanes.
- (10) In this section—
- left lane*** means—
- (a) the marked lane nearest to the far left side of the road; or
 - (b) if there is an obstruction, including, for example, a parked car or roadworks in that marked lane—the marked lane nearest to that marked lane that is not obstructed.
- marked lane***, for a driver, does not include a special purpose lane in which the driver is not permitted to drive.
- right lane*** means—
- (a) the marked lane nearest to the dividing line or median strip of the road; or

[s 112]

- (b) if there is an obstruction, including, for example, a parked car or roadworks in that marked lane—the marked lane nearest to that marked lane that is not obstructed.

112 Giving a left change of direction signal when entering a roundabout

- (1) This section applies to a driver entering a roundabout if—
 - (a) the driver is to leave the roundabout at the first exit after entering the roundabout; and
 - (b) the exit is less than halfway around the roundabout.
- (2) Before entering the roundabout, the driver must give a left change of direction signal for long enough to give sufficient warning to other drivers and pedestrians.

Maximum penalty—20 penalty units.

- (3) The driver must continue to give the change of direction signal until the driver has left the roundabout.

Maximum penalty—20 penalty units.

- (4) This section does not apply to a driver if the driver's vehicle is not fitted with direction indicator lights.

113 Giving a right change of direction signal when entering a roundabout

- (1) This section applies to a driver entering a roundabout if the driver is to leave the roundabout more than halfway around it.
- (2) Before entering the roundabout, the driver must give a right change of direction signal for long enough to give sufficient warning to other drivers and pedestrians.

Maximum penalty—20 penalty units.

- (3) The driver must continue to give the change of direction signal while the driver is driving in the roundabout, unless—
 - (a) the driver is changing marked lanes, or entering another line of traffic; or

- (b) the driver's vehicle is not fitted with direction indicator lights; or
 - (c) the driver is about to leave the roundabout.
- Maximum penalty—20 penalty units.

114 Giving way when entering or driving in a roundabout

- (1) A driver entering a roundabout must give way to—
 - (a) any vehicle in the roundabout; and
 - (b) a tram that is entering or approaching the roundabout.

Maximum penalty—20 penalty units.
- (2) A driver driving in a roundabout must give way to a tram that is in, entering or approaching the roundabout.
Maximum penalty—20 penalty units.
- (3) In this section—
tram includes a bus travelling along tram tracks.

115 Driving in a roundabout to the left of the central traffic island

- (1) A driver driving in a roundabout must drive—
 - (a) to the left of the central traffic island in the roundabout; or
 - (b) if subsection (2) applies to the driver—on the edge of the central traffic island, to the left of the centre of the island; or
 - (c) if subsection (3) applies to the driver—over the central traffic island, to the left of the centre of the island.

Maximum penalty—20 penalty units.
- (2) This subsection applies to a driver if—
 - (a) the driver's vehicle is too large to drive in the roundabout without driving on the edge of the central traffic island; and

[s 116]

- (b) the driver can safely drive on the edge of the central traffic island.
- (3) This subsection applies to a driver if—
 - (a) the driver's vehicle is too large to drive in the roundabout without driving over the central traffic island; and
 - (b) the central traffic island is designed to allow a vehicle of that kind to be driven over it.

116 Obeying traffic lane arrows when driving in or leaving a roundabout

If a driver is driving in a marked lane in a roundabout and there are traffic lane arrows applying to the lane, the driver must—

- (a) if the arrows indicate a single direction—drive in or leave the roundabout in that direction; or
- (b) if the arrows indicate 2 or more directions—drive in or leave the roundabout in 1 of those directions.

Maximum penalty—20 penalty units.

117 Giving a change of direction signal when changing marked lanes or lines of traffic in a roundabout

- (1) A driver driving in a roundabout must give a left change of direction signal before the driver changes marked lanes to the left, or enters a part of the roundabout where there is room for another line of traffic to the left, in the roundabout, unless the driver's vehicle is not fitted with direction indicator lights.

Maximum penalty—20 penalty units.

- (2) A driver driving in a roundabout must give a right change of direction signal before the driver changes marked lanes to the right, or enters a part of the roundabout where there is room for another line of traffic to the right, in the roundabout.

Maximum penalty—20 penalty units.

118 Giving a left change of direction signal when leaving a roundabout

- (1) If practicable, a driver driving in a roundabout must give a left change of direction signal when leaving the roundabout.

Maximum penalty—20 penalty units.

- (2) The driver must stop giving the change of direction signal as soon as the driver has left the roundabout.

Maximum penalty—20 penalty units.

- (3) This section does not apply to a driver if the driver's vehicle is not fitted with direction indicator lights.

119 Giving way by the rider of a bicycle or animal to a vehicle leaving a roundabout

The rider of a bicycle or animal who is riding in the far left marked lane of a roundabout with 2 or more marked lanes, or the far left line of traffic in a roundabout with room for 2 or more lines of traffic, other than animals, bicycles, motorbikes or motorised wheelchairs, must give way to any vehicle leaving the roundabout.

Maximum penalty—20 penalty units.

Part 10 Level crossings

120 What is a *level crossing*

- (1) A *level crossing*—

(a) is an area (the *primary area*) where—

- (i) a road and a railway meet at substantially the same level, whether or not there is a level crossing sign on the road at all or any of the entrances to the area; or

[s 121]

- (ii) a road and tram tracks meet at substantially the same level and that has a level crossing sign on the road at each entrance to the area; and
 - (b) includes any other area adjacent to the primary area that has cross-hatched road markings painted on it.
- (2) In this section—
road does not include a road-related area.

Examples of level crossing signs—



121 Stopping and giving way at a stop sign at a level crossing

A driver at a level crossing with a stop sign must—

- (a) stop as near as practicable to, but before reaching, the stop line or, if there is no stop line, as near as practicable to, but before reaching, the stop sign; and
- (b) give way to any train or tram on, approaching or entering the crossing.

Maximum penalty—20 penalty units.

Example—



Stop sign

122 Giving way at a give way sign or give way line at a level crossing

A driver at a level crossing with a give way sign or give way line must give way to any train or tram on, approaching or entering the crossing.

Maximum penalty—20 penalty units.

Example—



Give way sign

123 Entering a level crossing when a train or tram is approaching etc.

A driver must not enter a level crossing if—

- (a) warning lights (for example, twin red lights or rotating red lights) are operating or warning bells are ringing; or
- (b) a gate, boom or barrier at the crossing is closed or is opening or closing; or

[s 124]

- (c) a train or tram is on or entering the crossing; or
- (d) a train or tram approaching the crossing can be seen from the crossing, or is sounding a warning, and there would be a danger of a collision with the train or tram if the driver entered the crossing; or
- (e) the driver can not drive through the crossing because the crossing, or a road beyond the crossing, is blocked.

Maximum penalty—20 penalty units.

Example for paragraph (e)—

The crossing, or a road beyond the crossing, may be blocked by congested traffic, a disabled vehicle, a collision between vehicles or between a vehicle and a pedestrian, or by stock on the road.

124 Leaving a level crossing

A driver who enters a level crossing must leave the level crossing as soon as the driver can do so safely.

Maximum penalty—20 penalty units.

Part 11 Keeping left, overtaking and other driving rules

Division 1 General

125 Unreasonably obstructing drivers or pedestrians

- (1) A driver must not unreasonably obstruct the path of another driver or a pedestrian.

Maximum penalty—20 penalty units.

- (2) For this section, a driver does not unreasonably obstruct the path of another driver or a pedestrian only because—

- (a) the driver is stopped in traffic; or
- (b) the driver is driving more slowly than other vehicles (unless the driver is driving abnormally slowly in the circumstances).

Example of a driver driving abnormally slowly—

a driver driving at a speed of 20km/h on a length of road to which a speed limit of 80km/h applies when there is no reason for the driver to drive at that speed on the length of road

126 Keeping a safe distance behind vehicles

A driver must drive a sufficient distance behind a vehicle travelling in front of the driver so the driver can, if necessary, stop safely to avoid a collision with the vehicle.

Maximum penalty—20 penalty units.

127 Keeping a minimum distance between long vehicles

- (1) The driver of a long vehicle must drive at least the required minimum distance behind another long vehicle travelling in front of the driver, unless the driver is—
 - (a) driving on—
 - (i) a multi-lane road; or
 - (ii) a length of road in a built-up area; or
 - (b) overtaking.

Maximum penalty—20 penalty units.

- (2) In this section—

long vehicle means a vehicle that, together with any load or projection, is 7.5m long, or longer.

required minimum distance means—

- (a) for a road train—200m; or
- (b) otherwise—60m.

[s 128]

128 Entering blocked intersections

A driver must not enter an intersection if the driver can not drive through the intersection because the intersection, or a road beyond the intersection, is blocked.

Maximum penalty—20 penalty units.

Example—

The intersection, or a road beyond the intersection, may be blocked by congested traffic, a disabled vehicle, a collision between vehicles or between a vehicle and a pedestrian, or by a fallen load on the road.

128A Entering particular blocked crossings

A driver must not enter a bicycle crossing, children's crossing, marked foot crossing or pedestrian crossing if the driver can not drive through the crossing because the crossing, or a road beyond the crossing, is blocked.

Maximum penalty—20 penalty units.

Example—

The crossing, or a road beyond the crossing, may be blocked by congested traffic, a disabled vehicle, a collision between vehicles or between a vehicle and a pedestrian, or a fallen load on the road.

Division 2 Keeping to the left

129 Keeping to the far left side of a road

- (1) A driver on a road, other than a multi-lane road, must drive as near as practicable to the far left side of the road.

Maximum penalty—20 penalty units.

- (2) This section does not apply to—
 - (a) the rider of a motorbike; or
 - (b) the rider of a bicycle when entering or riding in a roundabout.
- (3) In this section—

road does not include a road-related area.

130 Keeping to the left on a multi-lane road

- (1) This section applies to a driver driving on a multi-lane road if—
 - (a) the speed limit applying to the driver for the length of road where the driver is driving is over 80km/h; or
 - (b) a keep left unless overtaking sign applies to the length of road where the driver is driving.
- (2) The driver must not drive in the right lane unless—
 - (a) the driver is—
 - (i) turning right or making a U-turn from the centre of the road; and
 - (ii) giving a right change of direction signal; or
 - (b) the driver is overtaking; or
 - (c) a left lane must turn left sign or left traffic lane arrows apply to any other lane and the driver is not turning left; or
 - (d) the driver is required to drive in the right lane under section 159; or
 - (e) the driver is avoiding an obstruction; or
 - (f) the traffic in each other lane is congested; or
 - (g) the traffic in every lane is congested; or
 - (h) the right lane is a special purpose lane in which the driver, under another provision of this regulation, is permitted to drive; or
 - (i) there are only 2 marked lanes and the left lane is a slow vehicle turn out lane.

Maximum penalty—20 penalty units.

[s 130]

- (3) A keep left unless overtaking sign on a multi-lane road applies to the length of road beginning at the sign and ending at the nearest of the following—
- (a) an end keep left unless overtaking sign on the road;
 - (b) a traffic sign or road marking on the road that indicates that the road is no longer a multi-lane road;
 - (c) if the road ends at a T-intersection or dead end—the end of the road.
- (4) In this section—

lane, for a driver, means a marked lane for vehicles travelling in the same direction as the driver, but does not include a special purpose lane in which the driver is not permitted to drive.

slow vehicle turn out lane means a marked lane, or the part of a marked lane, to which a slow vehicle turn out lane sign applies.

Note—

A slow vehicle turn out lane is designed for slow-moving vehicles to move into to allow faster vehicles to pass in an adjacent marked lane.

Examples—



Keep left unless overtaking sign

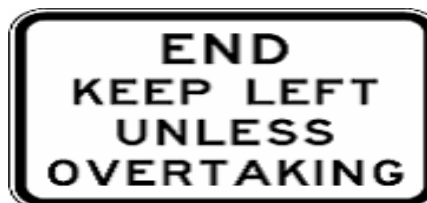

End keep left unless overtaking sign



Slow vehicle turn out lane sign

131 Keeping to the left of oncoming vehicles

- (1) A driver must drive to the left of any oncoming vehicle unless—
 - (a) the driver is turning right at an intersection; and
 - (b) the driver is passing an oncoming vehicle turning right at the intersection; and
 - (c) there is no traffic sign or road marking indicating that the driver must pass to the left of the oncoming vehicle.

Maximum penalty—20 penalty units.

- (2) This section does not apply to the rider of a motorbike that is a postal vehicle, the rider of a bicycle or the rider of an animal if—
 - (a) the rider is riding on a footpath, nature strip or shared path; and

[s 132]

- (b) the rider is permitted to ride on the footpath, nature strip or shared path under this regulation; and
- (c) either—
 - (i) the oncoming vehicle is not on the footpath, nature strip or shared path; or
 - (ii) the oncoming vehicle is not permitted, under this regulation, to be on the footpath, nature strip or shared path.

Examples—

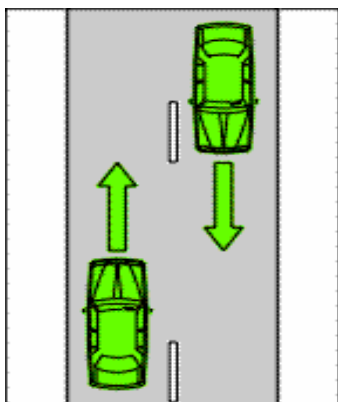

Example 1

Driving to the left of an oncoming vehicle

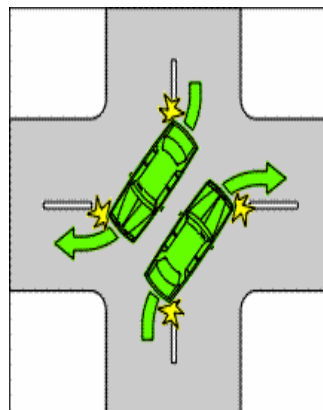

Example 2

Oncoming vehicles turning right passing to the right of each other

132 Keeping to the left of the centre of a road or the dividing line

- (1) A driver on a two-way road without a dividing line or median strip must drive to the left of the centre of the road, except as permitted under section 133, 139(1) or 139A(1).

Maximum penalty—20 penalty units.

- (2) A driver on a road with a dividing line (except 2 continuous dividing lines) must drive to the left of the dividing line, except as permitted under section 134, 139(2) or 139A(2).

Maximum penalty—20 penalty units.

- (2A) A driver on a road with a single continuous dividing line, a single continuous dividing line to the left of a broken dividing line or 2 parallel continuous dividing lines must not drive across the dividing lines to perform a U-turn.

Maximum penalty—20 penalty units.

- (3) A driver on a road with 2 continuous dividing lines must drive to the left of the dividing lines, except as permitted under section 139(2) or 139A(2).

Maximum penalty—20 penalty units.

- (4) This section, and sections 133, 134, 139(1) and (2) and 139A apply to a service road to which a two-way sign applies as if it were a separate road, but do not apply to any other service road.

- (5) In this section—

road does not include a footpath, nature strip, bicycle path, separated footpath or shared path.

Example of two-way sign—

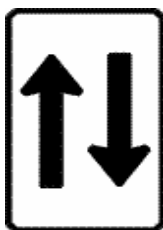

Two-way sign

[s 132]

Examples for subsection (2)—

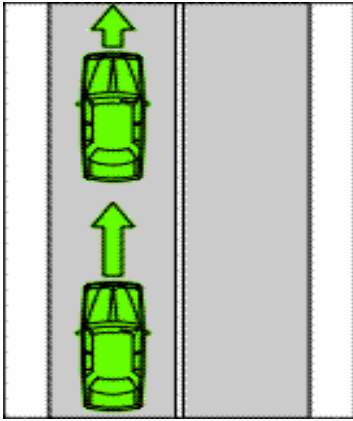

Example 1
Driving to the left of a single continuous dividing line only

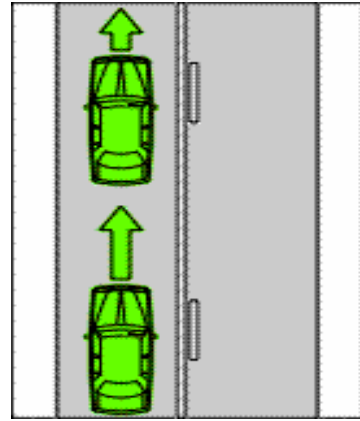

Example 2
Driving to the left of a single continuous dividing line to the left of a broken dividing line

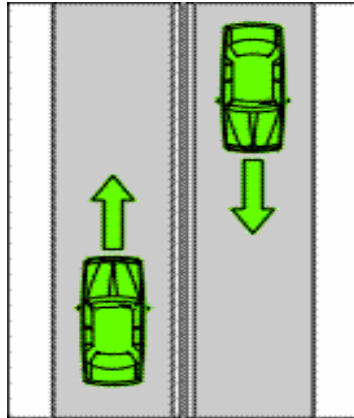

Example 3

Driving to the left of 2 parallel continuous dividing lines

Examples for subsection (2A)—

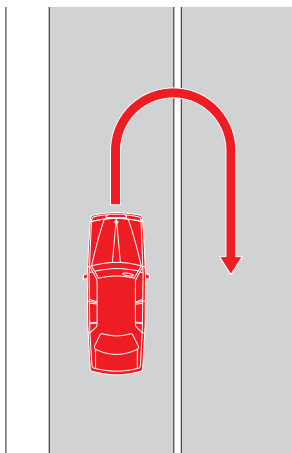

Example 4

Driving across a single continuous dividing line to perform a U-turn is not permitted

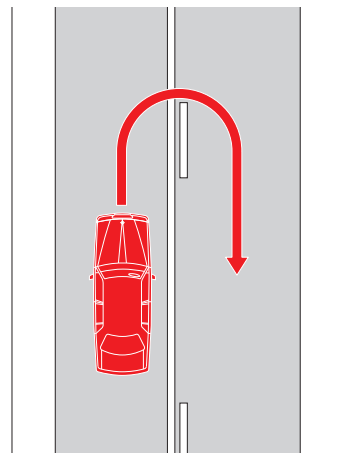

Example 5

Driving across a single continuous dividing line to the left of a broken dividing line to perform a U-turn is not permitted

[s 133]

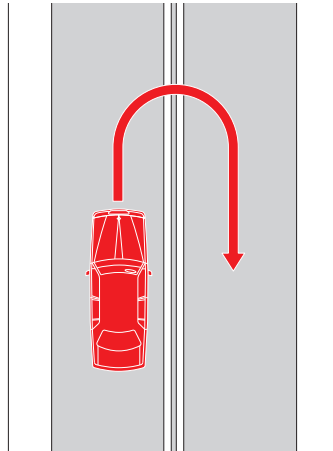

Example 6

Driving across 2 parallel continuous dividing lines to perform a U-turn is not permitted

133 Exceptions to keeping to the left of the centre of a road

- (1) This section applies to a driver on a two-way road without a dividing line or median strip.
- (2) The driver may drive to the right of the centre of the road—
 - (a) to overtake another driver; or
 - (b) to enter or leave the road; or
 - (c) to enter a part of the road of 1 kind from a part of the road of another kind (for example, moving to or from a service road or emergency stopping lane).
- (3) The driver may also drive to the right of the centre of the road if—
 - (a) because of the width or condition of the road, it is not practicable to drive to the left of the centre of the road; and
 - (b) the driver can do so safely.

134 Exceptions to keeping to the left of a dividing line

- (1) This section applies to a driver on a road with a dividing line.
- (2) If the dividing line is a single broken dividing line only, a broken dividing line to the left of a single continuous dividing line or 2 parallel broken dividing lines, the driver may drive to the right of the dividing line—
 - (a) to overtake another driver; or
 - (b) to perform a U-turn, unless the driver is prohibited from performing the U-turn under another provision of this regulation.
- (3) If the dividing line is a single continuous or broken dividing line, a broken dividing line to the left or right of a single continuous dividing line or 2 parallel broken dividing lines, the driver may drive to the right of the dividing line—
 - (a) to enter or leave the road; or
 - (b) to enter a part of the road of 1 kind from a part of the road of another kind (for example, moving to or from a service road or emergency stopping lane); or
 - (c) to park in angle parking on the opposite side of the road.

[s 134]

Examples—

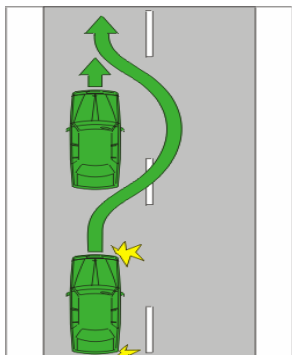

Example 1

Driving to the right of the centre of the road permitted—overtaking on a road with a broken dividing line only

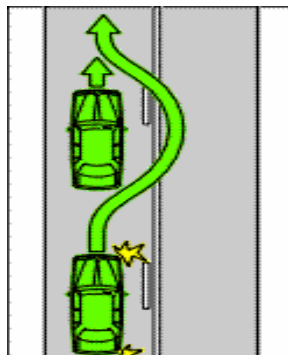

Example 2

Driving to the right of the centre of the road permitted—overtaking on a road with a broken dividing line to the left of a single continuous dividing line

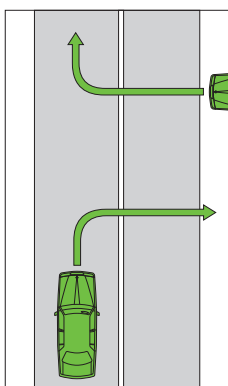

Example 2A

Driving across a single continuous dividing line is permitted to enter or leave the road

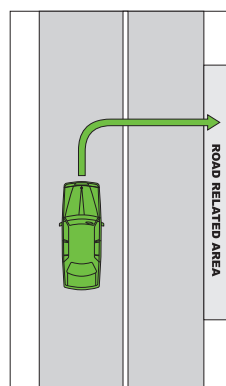

Example 2B

Driving across a single continuous dividing line is permitted to leave the road to enter a road-related area

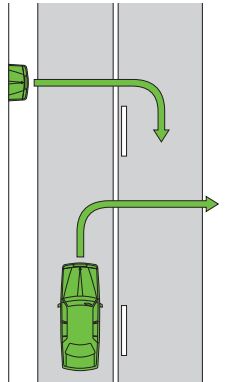

Example 2C

Driving across a single continuous dividing line to the left of a broken dividing line is permitted to enter or leave the road

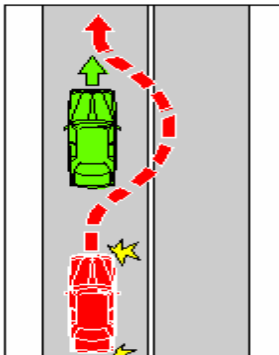

Example 3

Driving to the right of the centre of the road not permitted—overtaking on a road with a single continuous dividing line only

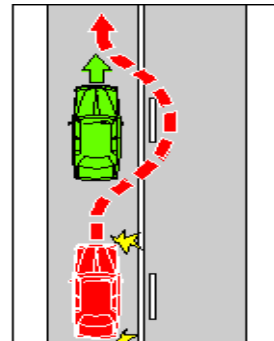

Example 4

Driving to the right of the centre of the road not permitted—overtaking on a road with a single continuous dividing line to the left of a broken dividing line

[s 135]

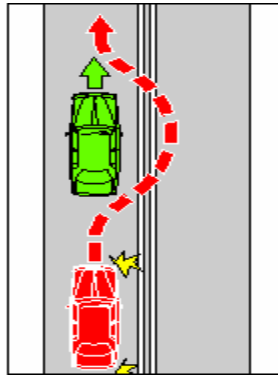

Example 5

Driving to the right of the centre of the road not permitted—overtaking on a road with 2 parallel continuous dividing lines

135 Keeping to the left of a median strip

- (1) A driver on a road with a median strip must drive to the left of the median strip, unless the driver is—
 - (a) entering or driving in a median strip parking area; or
 - (b) required to drive to the right of the median strip by a keep right sign.

Maximum penalty—20 penalty units.

- (2) In this section—
median strip does not include a painted island.

Example—



Keep right sign

136 Driving on a one-way service road

A driver on the part of the road that is a service road (except a service road to which a two-way sign applies) must drive in the same direction as a vehicle travelling on the part of the road closest to the service road must travel.

Maximum penalty—20 penalty units.

Example—

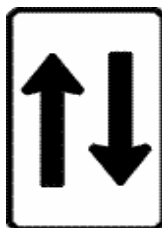

Two-way sign

137 Keeping off a dividing strip

(1) A driver must not drive on a dividing strip, except as permitted under this section or section 139(4) or 139A(3).

Maximum penalty—20 penalty units.

[s 138]

- (2) A driver may drive on a dividing strip that is at the same level as the road, and marked at each side by a continuous line—
 - (a) to enter or leave the road; or
 - (b) to enter or leave an area on the dividing strip to which a parking control sign applies if the driver is permitted to park in the area.
- (2A) For subsection (2), a dividing strip is taken to be at the same level as the road even if the dividing strip contains 1 or more pavement bars or markers.
- (3) In this section—

dividing strip does not include a painted island.

pavement bar means a raised rectangular block, with an approximately hemispherical cross-section, attached to an area of road, including, for example, a dividing strip—

- (a) perpendicular to the direction of travel of vehicles on the road; and
- (b) to—
 - (i) augment the visibility of the area; and
 - (ii) discourage, but not prohibit, movement of a vehicle in or across the area.

138 Keeping off a painted island

- (1) A driver must not drive on or over a single continuous line, or 2 parallel continuous lines, along a side of or surrounding a painted island, except as permitted under this section or section 139(4) or 139A(3).

Maximum penalty—20 penalty units.

Example—

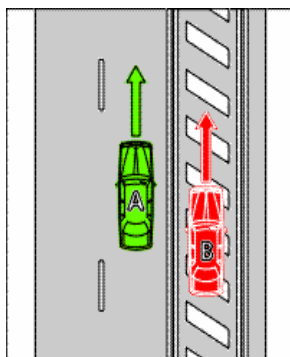

Painted island surrounded by 2 parallel continuous lines

In this example, vehicle B is contravening the section.

- (2) A driver may drive on or over a single continuous line along the side of or surrounding a painted island for up to 50m—
 - (a) to enter or leave the road; or
 - (b) to enter a turning lane that begins immediately after the painted island; or
 - (c) to enter a part of the road of one kind from a part of the road of another kind (for example, moving to or from a service road or emergency stopping lane); or
 - (d) to park in angle parking on the opposite side of the road.
- (3) Subsection (2)(a) does not apply in the case of a painted island—
 - (a) that separates a road that takes vehicles in 1 direction from another road that takes vehicles in the same direction at a place where the roads merge; or
 - (b) that separates 1 part of a road from other parts of the road to create a slip lane.

[s 139]

Examples—

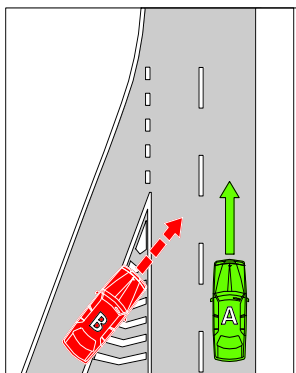

Example 1

Painted island separating traffic flow in the same direction

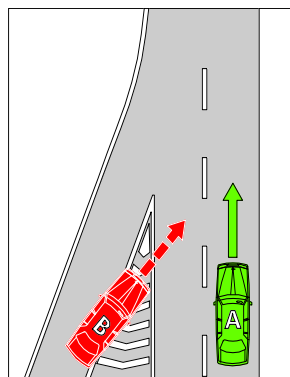

Example 2

Painted island separating traffic flow in the same direction

In examples 1 and 2, vehicle B is contravening the section.

139 Exceptions for avoiding obstructions on a road

- (1) A driver on a two-way road without a dividing line or median strip may drive to the right of the centre of the road to avoid an obstruction if—
 - (a) the driver has a clear view of any approaching traffic; and
 - (b) it is necessary and reasonable, in all the circumstances, for the driver to drive to the right of the centre of the road to avoid the obstruction; and
 - (c) the driver can do so safely.
- (2) A driver on a road with a dividing line may drive to the right of the dividing line to avoid an obstruction if—
 - (a) the driver has a clear view of any approaching traffic; and

-
- (b) it is necessary and reasonable, in all the circumstances, for the driver to drive to the right of the dividing line to avoid the obstruction; and
 - (c) the driver can do so safely.
- (3) For subsection (2), if the dividing line is a single continuous dividing line to the left of a broken dividing line, a single continuous dividing line only or 2 parallel continuous dividing lines, the hazard in driving to the right of the dividing line must be taken into account in deciding whether it is reasonable to drive to the right of the dividing line.
- (4) A driver may drive on a dividing strip, or on or over a single continuous line, or 2 parallel continuous lines, along a side of or surrounding a painted island, to avoid an obstruction if—
- (a) the driver has a clear view of any approaching traffic; and
 - (b) it is necessary and reasonable to drive on the dividing strip or painted island to avoid the obstruction; and
 - (c) the driver can do so safely.

139A Exceptions for passing bicycle rider

- (1) A driver on a two-way road without a dividing line or median strip may drive to the right of the centre of the road to pass the rider of a bicycle that is travelling in the same direction as the driver if—
- (a) the driver has a clear view of any approaching traffic; and
 - (b) the driving is necessary to comply with section 144A(1) for the passing of the rider; and
 - (c) the driver can do so safely.
- (2) A driver on a road with a dividing line may drive to the right of the dividing line to pass the rider of a bicycle that is travelling in the same direction as the driver if—
- (a) the driver has a clear view of any approaching traffic; and

[s 140]

- (b) the driving is necessary to comply with section 144A(1) for the passing of the rider; and
 - (c) the driver can do so safely.
- (3) A driver may drive on a dividing strip that is at the same level as the road, or on or over a single continuous line, or 2 parallel continuous lines, along a side of or surrounding a painted island to pass the rider of a bicycle that is travelling in the same direction as the driver if—
- (a) the driver has a clear view of any approaching traffic; and
 - (b) the driving is necessary to comply with section 144A(1) for the passing of the rider; and
 - (c) the driver can do so safely.

Note—

For the requirement to give a left or right change of direction signal, see section 46 or 48.

- (4) For subsection (3), a dividing strip is taken to be at the same level as the road even if the dividing strip contains 1 or more pavement bars or markers.

Division 3 Overtaking

140 No overtaking unless safe to do so

A driver must not overtake a vehicle unless—

- (a) the driver has a clear view of any approaching traffic; and
- (b) the driver can safely overtake the vehicle.

Maximum penalty—20 penalty units.

141 No overtaking etc. to the left of a vehicle

- (1) A driver (except the rider of a bicycle) must not overtake a vehicle to the left of the vehicle unless—

-
- (a) the driver is driving on a multi-lane road and the vehicle can be safely overtaken in a marked lane to the left of the vehicle; or
 - (b) the vehicle is turning right, or making a U-turn from the centre of the road, and is giving a right change of direction signal and it is safe to overtake to the left of the vehicle; or
 - (c) the vehicle is stationary and can be safely overtaken to the left of the vehicle.

Maximum penalty—20 penalty units.

- (2) The rider of a bicycle must not ride past, or overtake, to the left of a vehicle that is turning left and is giving a left change of direction signal.

Maximum penalty—20 penalty units.

- (3) In this section—

turning right does not include making a hook turn.

vehicle does not include a tram, a bus travelling along tram tracks, or any vehicle displaying a do not overtake turning vehicle sign.

142 No overtaking to the right of a vehicle turning right etc.

- (1) A driver must not overtake to the right of a vehicle if the vehicle is—
 - (a) turning right or making a U-turn from the centre of the road; and
 - (b) giving a right change of direction signal.

Maximum penalty—20 penalty units.

- (2) In this section—

turning right does not include making a hook turn.

vehicle does not include a tram, a bus travelling along tram tracks, or any vehicle displaying a do not overtake turning vehicle sign.

[s 143]

143 Passing or overtaking a vehicle displaying a do not overtake turning vehicle sign

- (1) A driver must not drive past, or overtake, to the left of a vehicle displaying a do not overtake turning vehicle sign, unless—
 - (a) if the vehicle is turning left and is giving a left change of direction signal—
 - (i) the driver is driving on a multi-lane road and it is safe to pass, or overtake, in a marked lane to the left of the vehicle; or
 - (ii) it is otherwise safe to pass, or overtake, to the left of the vehicle; or
 - (b) otherwise—
 - (i) the driver is driving on a multi-lane road and it is safe to pass, or overtake, in a marked lane to the left of the vehicle; or
 - (ii) the vehicle is turning right, or making a U-turn from the centre of the road, and is giving a right change of direction signal and it is safe to pass, or overtake, to the left of the vehicle; or
 - (iii) the vehicle is stationary and it is safe to pass, or overtake, to the left of the vehicle; or
 - (iv) it is otherwise safe to pass, or overtake, to the left of the vehicle.

Maximum penalty—20 penalty units.

- (2) A driver must not drive past, or overtake, to the right of a vehicle displaying a do not overtake turning vehicle sign if the vehicle is turning right, or making a U-turn from the centre of the road, and is giving a right change of direction signal, unless it is safe to do so.

Maximum penalty—20 penalty units.

Example—

A driver driving on a multi-lane road who is turning right at an intersection to which a right turn only sign applies may drive past a

vehicle displaying a do not overtake turning vehicle sign that is turning right from another marked lane, and giving a right change of direction signal, if it is safe to do so.

(3) In this section—

turning right does not include making a hook turn.

Examples of do not overtake turning vehicle signs—



144 Keeping a safe distance when overtaking

Subject to section 144A(1), a driver overtaking a vehicle—

- (a) must pass the vehicle at a sufficient distance to avoid a collision with the vehicle or obstructing the path of the vehicle; and
- (b) must not return to the marked lane or line of traffic where the vehicle is travelling until the driver is a sufficient distance past the vehicle to avoid a collision with the vehicle or obstructing the path of the vehicle.

Maximum penalty—20 penalty units.

144A Keeping a safe lateral distance when passing bicycle rider

- (1) The driver of a motor vehicle passing the rider of a bicycle that is travelling in the same direction as the driver must pass the bicycle at a sufficient distance from the bicycle.

Maximum penalty—40 penalty units.

[s 145]

Note—

Section 129 generally requires the rider of a bicycle on a road, other than a multi-lane road, to ride as near as practicable to the far left side of the road.

- (2) A *sufficient distance from the bicycle* is—
- (a) if the applicable speed limit is not more than 60km/h—a lateral distance from the bicycle of at least 1m; or
 - (b) if the applicable speed limit is more than 60km/h—a lateral distance from the bicycle of at least 1.5m.
- (3) For subsection (2), the lateral distance is the distance between the following points—
- (a) the furthestmost point to the left on the driver's vehicle or any projection from the vehicle (whether or not attached to the vehicle);
 - (b) the furthestmost point to the right on the bicycle, any bicycle trailer towed by the bicycle, the rider or any passenger in or on the trailer.

Example of what is part of a bicycle for paragraph (b)—

a basket or pannier bags attached to the bicycle

Example of what is not part of a bicycle for paragraph (b)—

a flag or stick, whether or not flexible, attached to the bicycle, that projects sideways from the bicycle

145 Driver being overtaken not to increase speed

If a driver is overtaking another driver on a two-way road by crossing a dividing line, or crossing to the right of the centre of the road, the other driver must not increase the speed at which the driver is driving until the first driver—

- (a) has passed the other driver; and
- (b) has returned to the marked lane or line of traffic where the other driver is driving; and
- (c) is a sufficient distance in front of the other driver to avoid a collision.

Maximum penalty—20 penalty units.

Division 4 Driving in marked lanes or lines of traffic

146 Driving within a single marked lane or line of traffic

- (1) A driver on a multi-lane road must drive so the driver's vehicle is completely in a marked lane, unless the driver is—
- (a) entering a part of the road of 1 kind from a part of the road of another kind (for example, moving to or from a service road or a shoulder of the road); or
 - (b) entering or leaving the road; or
 - (c) moving from 1 marked lane to another marked lane; or
 - (d) avoiding an obstruction; or
 - (e) obeying a traffic control device applying to the marked lane; or
 - (f) permitted to drive in more than 1 marked lane under this regulation; or
 - (g) passing the rider of a bicycle that is travelling in the same direction as the driver and the driver's vehicle is not completely in a marked lane in order to comply with section 144A(1) for the passing of the rider.

Maximum penalty—20 penalty units.

- (2) A driver on a road with 2 or more lines of traffic travelling in the same direction as the driver, but without marked lanes, must drive so the driver's vehicle is completely in a single line of traffic unless—
- (a) it is not practicable to drive completely in a single line of traffic; or
 - (b) the driver is entering a part of the road of 1 kind from a part of the road of another kind (for example, moving to or from a service road or a shoulder of the road); or

[s 147]

- (c) the driver is entering or leaving the road; or
- (d) the driver is moving from 1 line of traffic to another line of traffic; or
- (e) the driver is avoiding an obstruction; or
- (f) the driver is passing a bicycle that is travelling in the same direction as the driver and the driver's vehicle is not completely in a single line of traffic in order to comply with section 144A(1) for the passing of the rider.

Maximum penalty—20 penalty units.

147 Moving from 1 marked lane to another marked lane across a continuous line separating the lanes

- (1) A driver on a multi-lane road must not move from 1 marked lane to another marked lane by crossing a continuous line separating the lanes unless—
 - (a) the driver is avoiding an obstruction; or
 - (b) the driver is obeying a traffic control device applying to the first marked lane; or
 - (c) the driver is permitted to drive in both marked lanes under subsection (2); or
 - (d) either of the marked lanes is a special purpose lane in which the driver is permitted to drive under this regulation and the driver is moving to or from the special purpose lane; or
 - (e) either of the marked lanes is a special purpose lane during specified times only and the driver—
 - (i) is moving to or from the lane when it is not a special purpose lane; and
 - (ii) is permitted to drive in the lane when it is not a special purpose lane under this regulation.

Maximum penalty—20 penalty units.

-
- (2) A driver on a multi-lane road may move from 1 marked lane to another marked lane by crossing a continuous line separating the lanes if—
- (a) the driver makes the move to approach or enter an intersection from the multi-lane road and section 28(2) or 32(2) applies to the driver for the purpose of making the move; or
 - (b) the driver makes the move to approach or enter a roundabout from the multi-lane road and section 111(8) or (9) applies to the driver for the purpose of making the move; or
 - (c) both of the following apply—
 - (i) the driver is passing the rider of a bicycle that is travelling in the same direction as the driver and the movement is necessary to comply with section 144A(1) for the passing of the rider;
 - (ii) the driver can perform the movement safely.

148 Giving way when moving from 1 marked lane or line of traffic to another marked lane or line of traffic

- (1) A driver who is moving from 1 marked lane (whether or not the lane is ending) to another marked lane must give way to any vehicle travelling in the same direction as the driver in the marked lane to which the driver is moving.

Maximum penalty—20 penalty units.

[s 148A]

Examples—

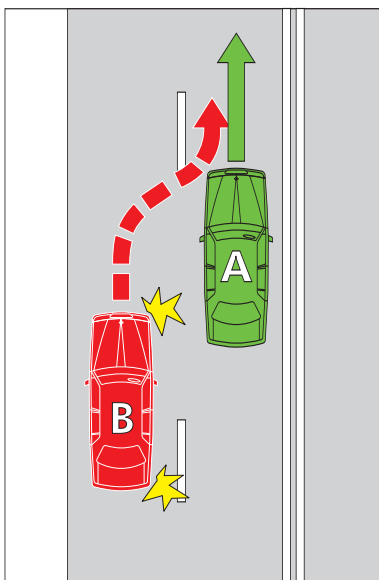

Example 1

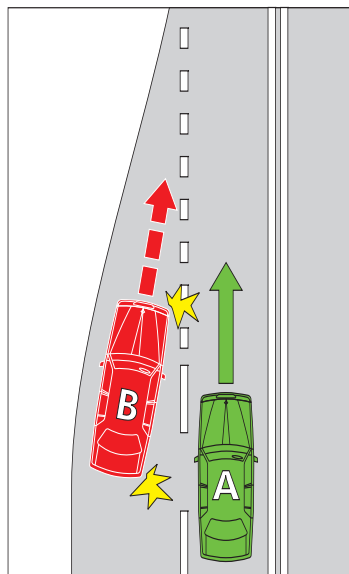

Example 2

In these examples, vehicle B must give way to vehicle A.

- (2) A driver on a road with 2 or more lines of traffic travelling in the same direction as the driver, and who is moving from 1 line of traffic to another line of traffic, must give way to any vehicle travelling in the same direction as the driver in the line of traffic to which the driver is moving.

Maximum penalty—20 penalty units.

- (3) Subsection (2) does not apply to a driver if the line of traffic in which the driver is driving is merging with the line of traffic to which the driver is moving.

148A Giving way when moving within a single marked lane

If a driver diverges to the left or right within a marked lane, the driver must give way to any vehicle that is in the lane.

Maximum penalty—20 penalty units.

149 Giving way when lines of traffic merge into a single line of traffic

A driver in a line of traffic that is merging with 1 or more lines of traffic travelling in the same direction as the driver must give way to a vehicle in another line of traffic if any part of the vehicle is ahead of the driver's vehicle.

Maximum penalty—20 penalty units.

Example—

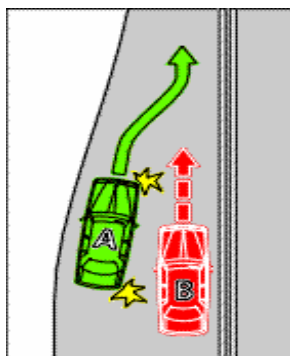

Giving way when lines of traffic merge into a single line of traffic

In this example, vehicle B must give way to vehicle A.

150 Driving on or across a continuous white edge line

- (1) A driver must not drive on or over a continuous white edge line on a road unless subsection (1A) or (1B) applies to the driver.

Maximum penalty—20 penalty units.

- (1A) A driver may drive on or over a continuous white edge line on a road if the driver is—
- (a) overtaking a vehicle that is turning right, or making a U-turn from the centre of the road, and is giving a right change of direction signal; or

[s 151]

- (b) driving a slow-moving vehicle, and it is necessary for the driver to drive on or over the edge line to allow the vehicle to be overtaken or passed by another vehicle; or
 - (c) driving a vehicle that is too wide, or too long, to drive on the road without driving on or over the edge line; or
 - (d) avoiding an obstruction.
- (1B) A driver may drive on or over a continuous white edge line on a road for up to 100m if the driver is—
- (a) turning at an intersection; or
 - (b) entering or leaving the road; or
 - (c) entering a part of the road of 1 kind from a part of the road of another kind (for example, moving to or from a service road, a shoulder of the road or an emergency stopping lane); or
 - (d) stopping at the side of the road (including any shoulder of the road).
- (2) This section does not apply to the rider of a bicycle or animal.
- (3) For this section, a driver drives over a continuous white edge line on a road if—
- (a) for a line on the far left side of the road—the driver's vehicle is completely or partly to the left of the line; or
 - (b) for a line on the far right side of the road—the driver's vehicle is completely or partly to the right of the line.

151 Riding a motorbike or bicycle alongside more than 1 other rider

- (1) The rider of a motorbike or bicycle must not ride on a road that is not a multi-lane road alongside more than 1 other rider, unless subsection (3) applies to the rider.

Maximum penalty—20 penalty units.

- (2) The rider of a motorbike or bicycle must not ride in a marked lane alongside more than 1 other rider in the marked lane, unless subsection (3) applies to the rider.

Maximum penalty—20 penalty units.

- (3) The rider of a motorbike or bicycle may ride alongside more than 1 other rider if the rider is overtaking the other riders.
- (4) If the rider of a motorbike or bicycle is riding on a road that is not a multi-lane road alongside another rider, or in a marked lane alongside another rider in the marked lane, the rider must ride not over 1.5m from the other rider.

Maximum penalty—20 penalty units.

- (5) In this section—

road does not include a road-related area, but includes a bicycle path, a shared path and any shoulder of the road.

Division 5 Obeying overhead lane control devices applying to marked lanes

152 Complying with overhead lane control devices

- (1) A driver in a marked lane to which an overhead lane control device applies must comply with this section.

Maximum penalty—20 penalty units.

- (2) If the device displays an illuminated red diagonal cross or is a traffic sign displaying a red diagonal cross, the driver must not drive in the marked lane past the device.
- (3) If the device displays a flashing illuminated red diagonal cross, the driver must leave the marked lane as soon as it is safe to do so.
- (4) If the device displays an illuminated white, green or yellow arrow pointing downwards or indicating 1 or more directions, the driver may drive in the marked lane past the device.

[s 152]

Example—

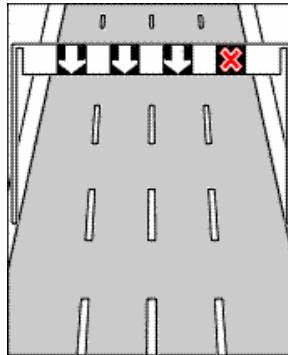

Overhead lane control device applying to marked lanes

- (5) Also, if the device displays a speed limit sign (variable illuminated message sign), the driver may drive in the marked lane past the device.

Note—

See also section 20.

- (6) A lane control ends sign on a road has the effect that once the driver has passed the sign, the overhead lane control device for which the sign is displayed no longer regulates which marked lanes the driver may or must drive in or must leave.

Example—



Lane control ends sign

Division 6 Driving in marked lanes designated for special purposes

153 Bicycle lanes

- (1) A driver (except the rider of a bicycle) must not drive in a bicycle lane, unless the driver is permitted to drive in the bicycle lane under this section or section 158.

Maximum penalty—20 penalty units.

- (2) If stopping or parking is permitted at a place in a bicycle lane under this regulation, a driver may drive for up to 50m in the bicycle lane to stop or park at that place.
- (3) A driver may drive for up to 50m in a bicycle lane if the driver is—
 - (a) driving a bus or taxi; and
 - (b) dropping off, or picking up, passengers.
- (4) A *bicycle lane* is a marked lane, or the part of a marked lane—

[s 154]

- (a) beginning at a bicycle lane sign applying to the lane, or a road marking consisting of a white bicycle symbol and the word 'lane' painted in white; and
- (b) ending at the nearest of the following—
 - (i) an end bicycle lane sign applying to the lane, or a road marking consisting of a white bicycle symbol and the words 'end lane' painted in white;
 - (ii) an intersection (unless the lane is at the unbroken side of the continuing road at a T-intersection or continued across the intersection by broken lines);
 - (iii) if the road ends at a dead end—the end of the road.

Examples—



Bicycle lane sign



End bicycle lane sign

154 Bus lanes

- (1) A driver must not drive in a bus lane, unless the driver is—
 - (a) driving—
 - (i) a bus; or
 - (ii) a bicycle or taxi; or
 - (b) permitted to drive in the bus lane under section 158.Maximum penalty—20 penalty units.
- (2) A **bus lane** is a marked lane, or the part of a marked lane—

- (a) beginning at a bus lane sign (whether or not there is also a bus lane road marking) and ending at the nearest of the following—
 - (i) an end bus lane sign;
 - (ii) a traffic sign that indicates the beginning of another special purpose lane; or
 - (b) beginning at a bus lane road marking (if there is no bus lane sign) and ending at the next intersection.
- (3) In this section—

bus lane road marking means a road marking consisting of—

- (a) the letters ‘BL’; or
- (b) the words ‘bus lane’; or
- (c) the words ‘bus only’.

Examples—



Bus lane sign



End bus lane sign

155 Tram lanes

- (1) A driver must not drive in a tram lane, unless the driver is—
 - (a) driving—
 - (i) a tram, tram recovery vehicle or bus; or
 - (ii) a bicycle, bus or taxi; or
 - (b) permitted to drive in the tram lane under this section or section 158.

[s 155]

Maximum penalty—20 penalty units.

- (2) A driver may drive in a tram lane if the driver is driving a truck and it is necessary for the driver to drive in the tram lane to reach a place to drop off, or pick up, passengers or goods.
- (3) A **tram lane** is a part of a road with tram tracks that—
 - (a) is between a tram lane sign and an end tram lane sign; and
 - (b) is marked along the left side of the tracks (when facing the direction of travel of a tram on the tracks) by a continuous yellow line parallel to the tracks.

Examples—



Tram lane sign



End tram lane sign

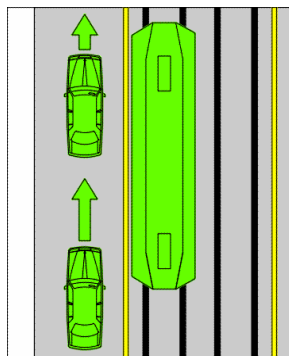

Tram lane

155A Tramways

- (1) A driver (except the driver of a tram, tram recovery vehicle or bus) must not drive in a tramway, unless the driver is permitted to drive in the tramway under subsection (2).

Maximum penalty—20 penalty units.

- (2) A driver may drive in a tramway if—
- (a) it is necessary for the driver to drive in the tramway to avoid an obstruction; and
 - (b) when driving in the tramway, the driver does not move into the path of an approaching tram or bus travelling in the tramway.
- (3) A *tramway* is a part of a road with tram tracks that—
- (a) is between a tramway sign and an end tramway sign; and
 - (b) is marked along the left side of the tracks (when facing the direction of travel of a tram on the tracks) by either—
 - (i) 2 continuous yellow lines parallel to the tracks; or
 - (ii) a structure (for example, a dividing strip, pedestrian refuge, traffic island, row of bollards or separation kerb), whether or not the structure is also being used to indicate a safety zone;
- but does include any part of the road where vehicles are permitted to cross the tramway.
- (4) For the purposes of subsection (3)(b)(i), a line is to be considered to be continuous despite any break in it that is designed to permit vehicles to cross the tramway.

[s 156]

Examples—



Tramway sign



End tramway sign

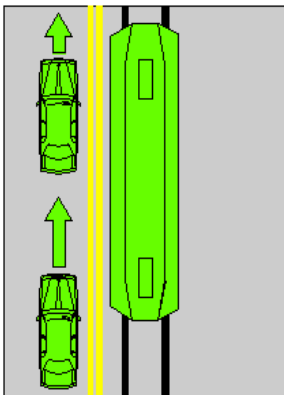

Tramway with double yellow line

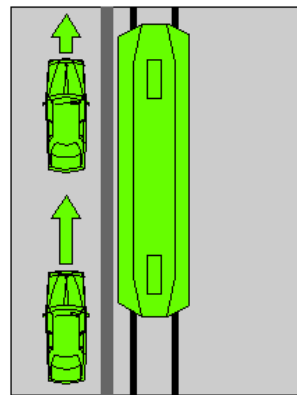

Tramway with separation kerb

156 Transit lanes

- (1) A driver must not drive in a transit lane, unless—
 - (a) the driver is driving—
 - (i) a bicycle, bus, motorbike, taxi or tram; or
 - (ii) if the transit lane sign applying to the transit lane is a transit lane (T2) sign—a vehicle carrying at least 1 other person; or

- (iii) if the transit lane sign applying to the transit lane is a transit lane (T3) sign—a vehicle carrying at least 2 other people; or
- (b) the driver is permitted to drive in the transit lane under section 158.

Maximum penalty—20 penalty units.

- (2) A **transit lane** is a marked lane, or the part of a marked lane—
 - (a) beginning at a transit lane sign; and
 - (b) ending at an end transit lane sign.

Examples of transit lane signs—



Transit lane (T2) sign



Transit lane (T3) sign

Examples of end transit lane signs—



End transit lane (T2) sign



End transit lane (T3) sign

157 Truck lanes

- (1) A driver must not drive in a truck lane, unless—

[s 158]

- (a) the driver is driving a truck; or
- (b) the driver is permitted to drive in the truck lane under section 158.

Maximum penalty—20 penalty units.

- (2) A **truck lane** is a marked lane, or the part of a marked lane—
- (a) beginning at a truck lane sign; and
 - (b) ending at an end truck lane sign.

Examples—



Truck lane sign



End truck lane sign

158 Exceptions to driving in special purpose lanes etc.

- (1) The driver of any vehicle may drive for up to the permitted distance in a bicycle lane, bus lane, tram lane, transit lane or truck lane if it is necessary for the driver to drive in the lane—
- (a) to enter or leave the road; or
 - (b) to enter a part of the road of 1 kind from a part of the road of another kind (for example, moving to or from a service road, the shoulder of the road or an emergency stopping lane); or
 - (c) to overtake a vehicle that is—
 - (i) turning right, or making a U-turn from the centre of the road; and
 - (ii) giving a right change of direction signal; or

-
- (d) to enter a marked lane, or a part of the road where there is room for a line of traffic, other than animals, bicycles, motorbikes or motorised wheelchairs, from the side of the road.
- (2) The driver of any vehicle may drive in a bicycle lane, bus lane, tram lane, transit lane or truck lane if—
 - (a) it is necessary for the driver to drive in the lane to avoid an obstruction; or
 - (b) information on or with a traffic sign applying to the lane indicates that the driver may drive in the lane.
 - (3) It is a defence to the prosecution of a driver for an offence against a provision of this division for driving in a bicycle lane, bus lane, tram lane, transit lane or truck lane if—
 - (a) it is necessary for the driver to drive in the lane to stop at a place in the lane; and
 - (b) either—
 - (i) the driver is permitted to stop at that place under this regulation; or
 - (ii) it is a defence under section 165 for the driver to stop at that place; and
 - (c) if the lane is a bicycle lane—the driver drives in the lane for no more than the permitted distance.
 - (4) In this section—

permitted distance means—

 - (a) for a bicycle lane or a tram lane—50m; or
 - (b) for any other lane—100m.

159 Marked lanes required to be used by particular kinds of vehicles

- (1) If information on or with a traffic sign applying to a length of road indicates that a vehicle of a particular kind must drive in a particular marked lane, a driver driving a vehicle of that

[s 159]

kind on the length of road must drive in the indicated lane, unless—

- (a) the driver is avoiding an obstruction; or
- (b) the driver is obeying a traffic control device applying to the indicated lane; or
- (c) the driver is permitted to drive in the indicated lane and also another marked lane under this regulation; or
- (d) the driver is intending to turn off the road or to make a U-turn and, in order to do so safely without disrupting other vehicles on the road, it is necessary to position the vehicle in another lane before starting or making the turn.

Maximum penalty—20 penalty units.

- (2) A traffic sign mentioned in this section that is on a road applies to the length of road beginning at the sign and ending at the nearest of the following—
 - (a) a traffic sign or road marking on the road that indicates that the first traffic sign no longer applies;
 - (b) the next intersection on the road;
 - (c) if the road ends at a T-intersection or dead end—the end of the road.

Examples of a traffic sign mentioned in the section and a traffic sign indicating that the first traffic sign no longer applies—



Trucks use left lane sign



End trucks use left lane sign

Division 7 Passing trams and safety zones

160 **Passing or overtaking a tram that is not at or near the left side of the road**

- (1) This section applies to a driver driving on a road with tram tracks that are not at or near the far left side of the road.
- (2) The driver must not drive past, or overtake, a tram to the right of the tram, unless a traffic sign or a road marking indicates that the driver may drive past, or overtake, the tram to the right of the tram.

Maximum penalty—20 penalty units.

- (3) The driver must not drive past, or overtake, a tram if the tram is turning left or is giving a left change of direction signal, unless—
 - (a) the driver is turning left; and
 - (b) there is no danger of a collision with the tram.

Maximum penalty—20 penalty units.

- (4) In this section—

tram includes a bus travelling along tram tracks.

161 **Passing or overtaking a tram at or near the left side of a road**

- (1) This section applies to a driver driving on a road with tram tracks at or near the far left side of the road.
- (2) The driver must not drive past, or overtake, a tram to the left of the tram unless the driver is turning left and there is no danger of a collision with the tram.

Maximum penalty—20 penalty units.

- (3) The driver must not drive past, or overtake, a tram if the tram is turning right or is giving a right change of direction signal.

Maximum penalty—20 penalty units.

[s 162]

(4) In this section—

tram includes a bus travelling along tram tracks.

162 Driving past a safety zone

(1) A driver driving past a safety zone—

- (a) must not drive on the safety zone; and
- (b) must drive to the left of the safety zone at a speed that does not put at risk the safety of any pedestrian crossing the road to or from the safety zone.

Maximum penalty—20 penalty units.

(2) A *safety zone* is an area of a road—

- (a) at a place with safety zone signs at or near a tram stop; and
- (b) indicated by a structure on the road (for example, a dividing strip, pedestrian refuge or traffic island).

Example—



Safety zone sign

163 Driving past the rear of a stopped tram at a tram stop

(1) This section applies if—

- (a) a driver is driving behind the rear of a tram travelling in the same direction as the driver; and
- (b) the tram stops at a tram stop, other than a tram stop at the far left side of the road; and

-
- (c) there is no safety zone, dividing strip or traffic island between the tram and the part of the road where the driver is driving.
- (2) The driver must stop before passing the rear of the tram.
Maximum penalty—20 penalty units.
- (3) After stopping under subsection (2), the driver must not drive past the tram if—
- (a) one or more of the doors on the side of the tram closest to the driver are open or opening; or
 - (b) a pedestrian is entering or crossing the road between the tram tracks and the far left side of the road.
- Maximum penalty—20 penalty units.
- (4) Also, after stopping under subsection (2), if the tram remains at the tram stop and subsection (3)(a) and (b) do not apply, the driver must not drive past the tram at a speed over 10km/h.
Maximum penalty—20 penalty units.
- (5) Subsections (2) to (4) do not apply to a driver if the driver is directed to drive past the tram by an authorised officer.
- (6) In this section—
tram includes a bus travelling along tram tracks.

164 Stopping beside a stopped tram at a tram stop

- (1) This section applies if—
- (a) a driver is driving alongside, or overtaking, a tram travelling in the same direction as the driver; and
 - (b) the tram stops at a tram stop, other than a tram stop at the far left side of the road; and
 - (c) there is no safety zone, dividing strip or traffic island between the tram and the part of the road where the driver is driving.
- (2) The driver must stop when the tram stops.

[s 164AA]

Maximum penalty—20 penalty units.

- (3) After stopping under subsection (2), the driver must not drive past, or overtake, the tram if—
- (a) one or more of the doors on the side of the tram closest to the driver are open or opening; or
 - (b) a pedestrian is entering or crossing the road between the tram tracks and the far left side of the road.

Maximum penalty—20 penalty units.

- (4) Also, after stopping under subsection (2), if the tram remains at the tram stop and subsection (3)(a) and (b) do not apply, the driver must not drive past, or overtake, the tram at a speed over 10km/h.

Maximum penalty—20 penalty units.

- (5) Subsections (2) to (4) do not apply to a driver if the driver is directed to drive past the tram by an authorised officer.
- (6) In this section—
tram includes a bus travelling along tram tracks.

164AA Staying stopped if a tram comes from behind a stopped driver and stops

- (1) This section applies if—
- (a) a driver is stopped beside a tram stop; and
 - (b) a tram stops at the tram stop, other than at the far left side of the road; and
 - (c) there is no safety zone, dividing strip or traffic island between the tram and the part of the road where the driver is driving.
- (2) The driver must not proceed if—
- (a) one or more of the doors on the side of the tram closest to the driver are open or opening; or
 - (b) a pedestrian is entering or crossing the road between the tram tracks and the far left side of the road.

Maximum penalty—20 penalty units.

- (3) If the tram remains at the tram stop and subsection (2)(a) and (b) do not apply, the driver must not drive past the tram at a speed over 10km/h.

Maximum penalty—20 penalty units.

- (4) Subsections (2) and (3) do not apply to a driver if the driver is directed to drive past the tram by an authorised officer.
- (5) In this section—
tram includes a bus travelling along tram tracks.

Part 12 Restrictions on stopping and parking

Division 1 General

164A Minor traffic offences

For section 108 of the Act, definition *minor traffic offence*, the offences in this part are prescribed.

165 Stopping in an emergency etc. or to comply with another provision

It is a defence to the prosecution of a driver for an offence against a provision of this part if—

- (a) the driver stops at a particular place, or in a particular way, to avoid a collision, and the driver stops for no longer than is necessary to avoid the collision; or
- (b) the driver stops at a particular place, or in a particular way, because the driver's vehicle is disabled, and the driver stops for no longer than is necessary for the

[s 166]

vehicle to be moved safely to a place where the driver is permitted to park the vehicle under the Act; or

- (c) the driver stops at a particular place, or in a particular way, to deal with a medical or other emergency, or to assist a disabled vehicle, and the driver stops for no longer than is necessary in the circumstances; or
- (d) the driver stops at a particular place, or in a particular way, because the condition of the driver, a passenger, or the driver's vehicle makes it necessary for the driver to stop in the interests of safety, and the driver stops for no longer than is necessary in the circumstances; or
- (e) the driver stops at a particular place, or in a particular way, to comply with this regulation, and the driver stops for no longer than is necessary to comply with the other provision.

Example for paragraph (e)—

If a driver stops at an intersection at a stop line, stop sign, or traffic lights, or to give way to a vehicle, the driver does not contravene section 170 (Stopping in or near an intersection).

166 Application of part to bicycles

This part does not apply to a bicycle that is parked at a bicycle rail or in a bicycle rack.

Division 2 No stopping and parking signs and road markings

167 No stopping signs

A driver must not stop on a length of road or in an area to which a no stopping sign applies.

Maximum penalty—20 penalty units.

Examples of no stopping signs—



No stopping sign (for a length of road)



No stopping sign (for an area)

168 No parking signs

- (1) The driver of a vehicle must not stop on a length of road or in an area to which a no parking sign applies, unless the driver—
 - (a) is dropping off, or picking up, passengers or goods; and
 - (b) does not leave the vehicle unattended; and
 - (c) completes the dropping off, or picking up, of the passengers or goods, and drives on, as soon as possible and, in any case, within the required time after stopping.

Maximum penalty—20 penalty units.

- (2) For this section, a driver leaves a vehicle *unattended* if the driver leaves the vehicle so the driver is over 3m from the closest point of the vehicle.
- (3) In this section—

required time means—

- (a) if information on or with the sign indicates a time—the indicated time; or
- (b) if there is no indicated time—2 minutes; or
- (c) if there is no indicated time, or the indicated time is less than 5 minutes, and section 206 applies to the driver—5 minutes.

[s 169]

Examples of no parking signs—



No parking sign (for a length of road)



No parking sign (for an area)

169 No stopping on a road with a yellow edge line

A driver must not stop at the side of a road marked with a continuous yellow edge line.

Maximum penalty—20 penalty units.

Division 3 Stopping at intersections and crossings

170 Stopping in or near an intersection

- (1) A driver must not stop at a place in an intersection unless—
 - (a) the driver is permitted to stop at the place under this regulation; or
 - (b) the intersection is a T-intersection without traffic lights and the driver stops along the continuous side of the continuing road at the intersection.

Maximum penalty—20 penalty units.

- (2) A driver must not stop on a road within 20m from the nearest point of an intersecting road at an intersection with traffic lights, unless the driver—
 - (a) stops at a place on a length of road, or in an area, to which a parking control sign applies; and

(b) is permitted to stop at that place under this regulation.

Maximum penalty—20 penalty units.

(3) However, subsection (2) does not apply if a no stopping sign is installed within 20m from the nearest point.

Example—

If a no stopping sign is installed 6m from the nearest point of an intersecting road to which subsection (2) would otherwise apply, it is not an offence against subsection (2) for a driver to stop within 20m, but more than 6m, from the nearest point.

(4) A driver must not stop on a road within 10m from the nearest point of an intersecting road at an intersection without traffic lights, unless—

(a) the driver—

(i) stops at a place on a length of road, or in an area, to which a parking control sign applies; and

(ii) is permitted to stop at that place under this regulation; or

(b) if the intersection is a T-intersection—the driver stops along the continuous side of the continuing road at the intersection.

Maximum penalty—20 penalty units.

(5) However, subsection (4) does not apply if a no stopping sign is installed within 10m from the nearest point.

(6) For this section, distances are measured—

(a) in the direction in which the driver is driving; and

(b) as shown in—

(i) for subsection (2)—example 1; or

(ii) for subsection (4)—example 2.

(7) In this section—

road does not include a road-related area, but includes any shoulder of the road.

[s 171]

Examples—

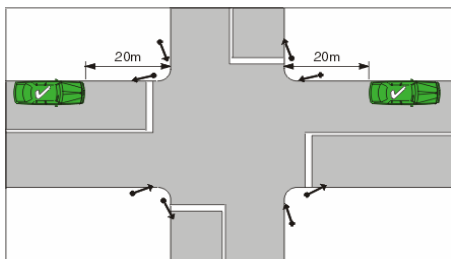

Example 1
Measurement of distance—intersection
with traffic lights

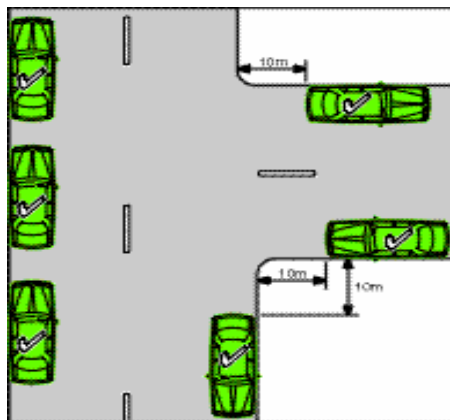

Example 2
Measurement of
distance—T-intersection
without traffic
lights

171 Stopping on or near a children's crossing

- (1) A driver must not—
 - (a) stop on a children's crossing; or
 - (b) stop on a road within 20m before a children's crossing or 10m after a children's crossing, unless the driver—
 - (i) stops at a place on a length of road, or in an area, to which a parking control sign applies; and
 - (ii) is permitted to stop at that place under this regulation.

Maximum penalty—20 penalty units.

- (2) For this section, distances are measured—
 - (a) in the direction in which the driver is driving; and
 - (b) as shown in example 1 or 2.

(3) In this section—

road does not include a road-related area, but includes any shoulder of the road.

Examples—

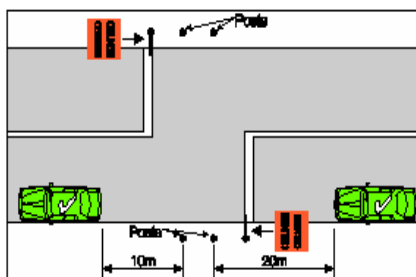

Example 1

Measurement of distance—children's crossing with red and white posts

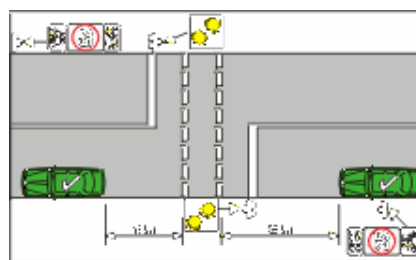

Example 2

Measurement of distance—children's crossing with 2 parallel continuous or broken lines

172 Stopping on or near a pedestrian crossing (except at an intersection)

(1) A driver must not stop on a pedestrian crossing that is not at an intersection, or on the road within 20m before the crossing and 10m after the crossing, unless the driver—

- (a) stops at a place on a length of road, or in an area, to which a parking control sign applies; and
- (b) is permitted to stop at that place under this regulation.

Maximum penalty—20 penalty units.

(2) For this section, distances are measured—

- (a) in the direction in which the driver is driving; and
- (b) as shown in the example.

(3) In this section—

road does not include a road-related area, but includes any shoulder of the road.

[s 173]

Example—

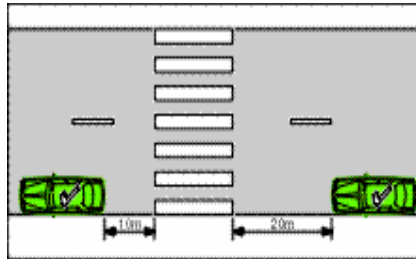

Measurement of distance—pedestrian crossing

173 Stopping on or near a marked foot crossing (except at an intersection)

- (1) A driver must not stop on a marked foot crossing that is not at an intersection, or on the road within 10m before the traffic lights pole nearest to the driver at the crossing and 3m after the crossing, unless the driver—
 - (a) stops at a place on a length of road, or in an area, to which a parking control sign applies; and
 - (b) is permitted to stop at that place under this regulation.

Maximum penalty—20 penalty units.

- (2) For this section, distances are measured—
 - (a) in the direction in which the driver is driving; and
 - (b) as shown in the example.

- (3) In this section—

road does not include a road-related area, but includes any shoulder of the road.

Example—

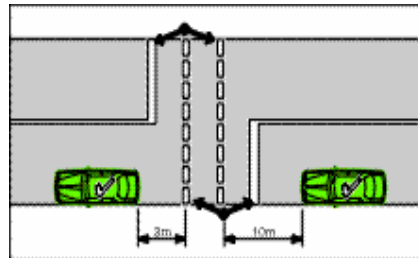

Measurement of distance—marked foot crossing

174 Stopping on or near a bicycle crossing (except at an intersection)

- (1) This section applies to a bicycle crossing that is not at an intersection.
- (2) A driver driving along the road on which the crossing is located must not stop on the crossing, or on the road within 10m before the traffic lights nearest to the driver at the crossing and 3m after the crossing, unless the driver—
 - (a) stops at a place on a length of road, or in an area, to which a parking control sign applies; and
 - (b) is permitted to stop at that place under this regulation.

Maximum penalty—20 penalty units.

- (3) For this section, distances are measured—
 - (a) in the direction in which the driver is driving; and
 - (b) as shown in the example.

- (4) In this section—

road does not include a road-related area, but includes any shoulder of the road.

[s 175]

Example—

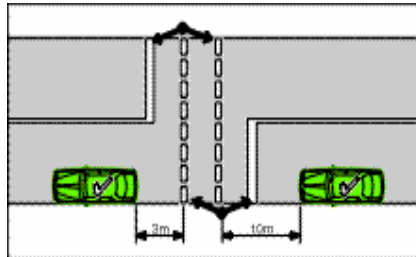

Measurement of distance—bicycle crossing lights

175 Stopping on or near a level crossing

- (1) A driver must not stop on a level crossing, or on a road within 20m before the nearest rail or track to the driver approaching the crossing and 20m after the nearest rail or track to the driver leaving the crossing, unless the driver—
 - (a) stops at a place on a length of road, or in an area, to which a parking control sign applies; and
 - (b) is permitted to stop at that place under this regulation.

Maximum penalty—20 penalty units.

- (2) For this section, distances are measured as shown in the example.
- (3) In this section—

road does not include a road-related area, but includes any shoulder of the road.

Example—

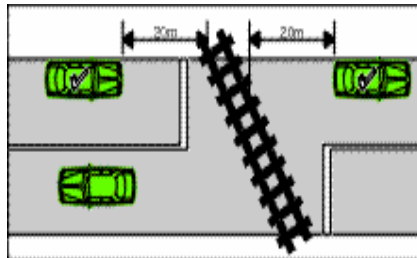

Measurement of distance—level crossing

Division 4 Stopping on clearways and freeways and in emergency stopping lanes

176 Stopping on a clearway

(1) A driver must not stop on a length of road, other than a road-related area, to which a clearway sign applies, unless the driver is—

- (a) driving a bus or taxi; and
- (b) dropping off, or picking up, passengers.

Maximum penalty—20 penalty units.

(2) A clearway sign applies, for the days or times indicated on the sign, to a length of road beginning at the sign and ending at the nearest of the following—

- (a) a clearway sign on the road that indicates different days or times;
- (b) an end clearway sign on the road;
- (c) the end of the road.

[s 177]

Examples—

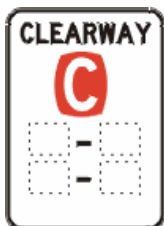

Clearway sign



End clearway signs

177 Stopping on a freeway

- (1) A driver must not stop on a freeway, unless the driver stops in an emergency stopping lane.

Maximum penalty—20 penalty units.

- (2) A **freeway** is a length of road to which a freeway sign applies.
- (3) A freeway sign on a road applies to a length of road beginning at the sign (including any road into which the length of road merges) and ending at the next end freeway sign on the road.

Examples of freeway signs—



Example of end freeway sign—



178 Stopping in an emergency stopping lane

A driver (except the rider of a bicycle) must not stop in an emergency stopping lane unless—

- (a) the condition of the driver, a passenger or the driver's vehicle, or any other factor, makes it necessary or desirable for the driver to stop in the emergency stopping lane in the interests of safety; and
- (b) the driver stops for no longer than is necessary in the circumstances.

Maximum penalty—20 penalty units.

Division 5 Stopping in zones for particular vehicles

179 Stopping in a loading zone

- (1) A driver must not stop in a loading zone, unless the driver is driving—
 - (a) a bus that is dropping off, or picking up, passengers; or
 - (b) a truck that is dropping off, or picking up, passengers or goods; or
 - (c) a motor vehicle displaying a commercial vehicle identification label issued by the local government for the local government area in which the loading zone is situated; or

[s 179]

- (d) another motor vehicle that is—
 - (i) dropping off, or picking up, goods; or
 - (ii) dropping off, or picking up, passengers.

Maximum penalty—20 penalty units.

- (2) A driver who is permitted to stop in a loading zone under subsection (1)(a), (b) or (c) must not stay continuously in the zone for longer than—
 - (a) 30 minutes; or
 - (b) if information on or with the loading zone signs applying to the loading zone indicates another time—the indicated time.

Maximum penalty—20 penalty units.

- (2A) A driver who is permitted to stop in a loading zone under subsection (1)(d)(i) must not stay continuously in the zone for longer than—
 - (a) 20 minutes; or
 - (b) if information on or with the loading zone signs applying to the loading zone indicates another time—the indicated time.

Maximum penalty—20 penalty units.

- (2B) A driver who is permitted to stop in a loading zone under subsection (1)(d)(ii) must not stay continuously in the zone for longer than 2 minutes.

Maximum penalty—20 penalty units.

- (3) A **loading zone** is a length of a road to which a loading zone sign applies.

Example—



Loading zone sign

180 Stopping in a truck zone

- (1) A driver must not stop in a truck zone, unless the driver is driving a truck that is dropping off, or picking up, passengers or goods.

Maximum penalty—20 penalty units.

- (2) A *truck zone* is a length of a road to which a truck zone sign applies.

Example—



Truck zone sign

181 Stopping in a works zone

- (1) A driver must not stop in a works zone, unless the driver is driving a vehicle that is engaged in construction work in or near the zone.

[s 182]

Maximum penalty—20 penalty units.

- (2) A **works zone** is a length of a road to which a works zone sign applies.

Example—



Works zone sign

182 Stopping in a taxi zone

- (1) A driver must not stop in a taxi zone, unless the driver is driving a taxi.

Maximum penalty—20 penalty units.

- (2) A **taxi zone** is a length of a road to which a taxi zone sign applies.

Example—



Taxi zone sign

183 Stopping in a bus zone

- (1) A driver must not stop in a bus zone, unless the driver is driving a bus (except a bus of a kind that is not permitted to stop in the bus zone by information on or with the bus zone sign applying to the bus zone).

Maximum penalty—20 penalty units.

- (2) A *bus zone* is a length of a road to which a bus zone sign applies.

Example—



Bus zone sign

184 Section number not used

185 Stopping in a permit zone

- (1) A driver must not stop in a permit zone, unless the driver's vehicle displays a current permit issued under this regulation that permits the vehicle to stop in the zone.

Maximum penalty—20 penalty units.

- (2) A *permit zone* is a length of a road to which a permit zone sign applies.

[s 186]

Example—



Permit zone sign

186 Stopping in a mail zone

- (1) A driver must not stop in a mail zone.
Maximum penalty—20 penalty units.
- (2) A *mail zone* is a length of a road to which a mail zone sign applies.

Example—



Mail zone sign

Division 6 Other places where stopping is restricted

187 Stopping in a bus lane, tram lane, tramway, transit lane, truck lane or on tram tracks

- (1) A driver must not stop in a bus lane, transit lane or truck lane, unless the driver—
- (a) is—
 - (i) driving a bus or taxi; and
 - (ii) dropping off, or picking up, passengers; or
 - (b) is permitted to drive in the lane under this regulation.

Maximum penalty—20 penalty units.

- (2) A driver (except the driver of a tram, a tram recovery vehicle or a bus) must not stop in a tram lane, a tramway or on tram tracks.

Maximum penalty—20 penalty units.

188 Stopping in a shared zone

A driver must not stop in a shared zone unless—

- (a) the driver stops at a place on a length of road, or in an area, to which a parking control sign applies and the driver is permitted to stop at that place under the Act; or
- (b) the driver—
 - (i) stops in a parking bay; and
 - (ii) is permitted to stop in the parking bay under this regulation; or
- (c) the driver is dropping off, or picking up, passengers or goods; or

[s 189]

- (d) the driver is engaged in the door-to-door delivery or collection of goods, or in the collection of waste or garbage.

Maximum penalty—20 penalty units.

189 Double parking

- (1) A driver must not stop on a road if to do so would put any part of the vehicle that the driver is driving between a vehicle that is parked on the road and the centre of the road.

Maximum penalty—20 penalty units.

- (2) A driver does not contravene subsection (1) by parking on the side of the road, or in a median strip parking area, in accordance with section 210.

Examples—

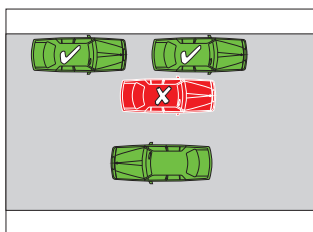

Example 1
**Double parked on a two-way road
without a dividing line**

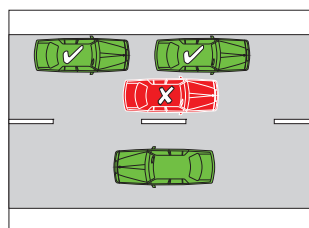

Example 2
**Double parked on a two-way road with a
centre dividing line**

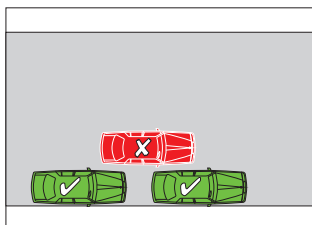

Example 3

Double parked on the right side of a one-way road with no vehicles parked on the left side of the road

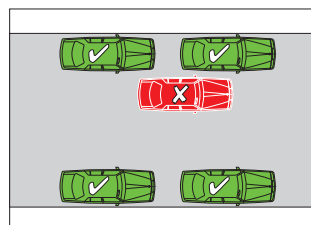

Example 4

Double parked on the left side of a one-way road with other vehicles lawfully parked on the right side of the road

In the examples, a vehicle marked with an 'X' is stopped in contravention of this section.

190 Stopping in or near a safety zone

- (1) A driver must not stop in a safety zone, or on a road within 10m before or after a safety zone, unless the driver—
 - (a) stops at a place on a length of road, or in an area, to which a parking control sign applies; and
 - (b) is permitted to stop at that place under this regulation.Maximum penalty—20 penalty units.
- (2) For this section, distances are measured—
 - (a) in the direction in which the driver is driving; and
 - (b) from the end of the structure; and
 - (c) as shown in example 2.
- (3) In this section—

road does not include a road-related area, but includes any shoulder of the road.

[s 191]

Examples—



Example 1
Safety zone sign

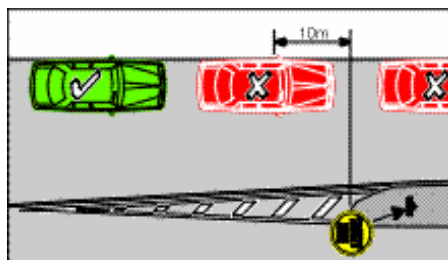

Example 2
Measurement of distance—safety zone

In example 2, the vehicles marked with an 'X' are stopped in contravention of this section.

191 Stopping near an obstruction

A driver must not stop on a road near an obstruction on the road in a position that obstructs traffic on the road.

Maximum penalty—20 penalty units.

192 Stopping on a bridge or in a tunnel etc.

- (1) A driver must not stop on a bridge, causeway, ramp or similar structure unless—
 - (a) the road is at least as wide on the structure as it is on each of the approaches; or
 - (b) the driver—
 - (i) stops at a place on a length of road, or in an area, to which a parking control sign applies; and
 - (ii) is permitted to stop at that place under this regulation.

Maximum penalty—20 penalty units.

- (2) A driver must not stop in a tunnel or underpass unless—

- (a) the road is at least as wide in the tunnel or underpass as it is on each of the approaches; or
- (b) the driver—
 - (i) stops at a place on a length of road, or in an area, to which a parking control sign applies; and
 - (ii) is permitted to stop at that place under this regulation.

Maximum penalty—20 penalty units.

Example—

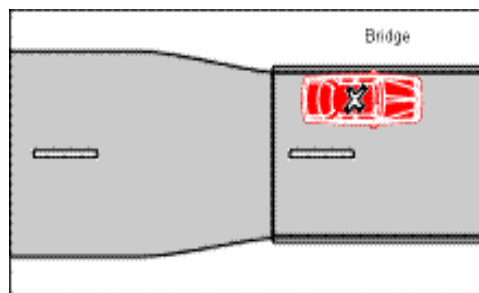

Stopping on a bridge where the road on the bridge is narrower than on an approach
In the example, the vehicle is stopped in contravention of subsection (1).

193 Stopping on a crest or curve outside a built-up area

- (1) A driver must not stop on or near a crest or curve on a length of road that is not in a built-up area unless—
 - (a) the driver's vehicle is visible for 100m to drivers approaching the vehicle and travelling in the direction of travel of traffic on the same side of the road as the vehicle; or
 - (b) the driver—
 - (i) stops at a place on a length of road, or in an area, to which a parking control sign applies; and

[s 194]

(ii) is permitted to stop at that place under this regulation.

Maximum penalty—20 penalty units.

(2) In this section—

road does not include a road-related area, but includes any shoulder of a road.

194 Stopping near a fire hydrant etc.

(1) A driver must not stop within 1m of a fire hydrant, fire hydrant indicator, or fire plug indicator, unless—

(a) the driver—

(i) is driving a bus; and

(ii) stops at a bus stop or in a bus zone; and

(iii) does not leave the bus unattended; or

(b) the driver—

(i) is driving a taxi; and

(ii) stops in a taxi zone; and

(iii) does not leave the taxi unattended.

Maximum penalty—20 penalty units.

(2) For this section, a driver leaves a vehicle *unattended* if the driver leaves the vehicle so the driver is over 3m from the closest point of the vehicle.

(3) In this section—

fire hydrant means an upright pipe with a spout, nozzle or other outlet for drawing water from a main or service pipe in case of fire or other emergency.

Examples—

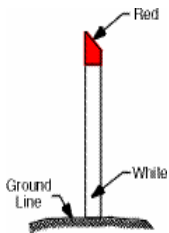

Fire hydrant indicators

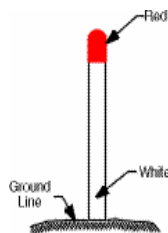
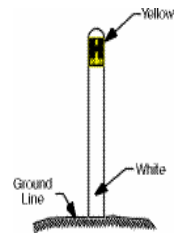

Fire plug indicator

195 Stopping at or near a bus stop

- (1) A driver (except the driver of a bus) must not stop at a bus stop, or on the road, within 20m before a sign on the road that indicates the bus stop, and 10m after the sign, unless the driver—
 - (a) stops at a place on a length of road, or in an area, to which a parking control sign applies; and
 - (b) is permitted to stop at that place under this regulation.

Maximum penalty—20 penalty units.

- (2) For this section, distances are measured in the direction in which the driver is driving.

[s 196]

- (3) In this section—

road does not include a road-related area, but includes any shoulder of the road.

196 Stopping at or near a tram stop

- (1) A driver (except the driver of a tram, a tram recovery vehicle or a bus travelling along tram tracks) must not stop at a tram stop or on the road within 20m before a sign that indicates a tram stop, unless—
- (a) the driver stops at a place on a length of road, or in an area, to which a parking control sign applies; and
 - (b) the driver is permitted to stop at that place under this regulation.

Maximum penalty—20 penalty units.

- (2) For this section, the distance is measured in the direction in which the driver is driving.
- (3) In this section—
- road* does not include a road-related area, but includes any shoulder of the road.

197 Stopping on a path, dividing strip, nature strip, painted island or traffic island

- (1) A driver must not stop on a bicycle path, footpath, shared path or dividing strip, or a nature strip adjacent to a length of road in a built-up area, unless the driver—
- (a) stops at a place on a length of road, or in an area, to which a parking control sign applies; and
 - (b) is permitted to stop at that place under this regulation.

Maximum penalty—20 penalty units.

- (1A) A driver must not stop on a painted island.

Maximum penalty—20 penalty units.

- (1B) A driver must not stop on a traffic island.

Maximum penalty—20 penalty units.

- (2) Subsections (1) and (1B) do not apply to the rider of a bicycle or animal.

198 Obstructing access to and from a footpath, driveway etc.

- (1) A driver must not stop on a road in a position that obstructs access by vehicles or pedestrians to or from a footpath ramp or a similar way of access to a footpath, or a bicycle path or passageway unless—
- (a) the driver is driving a bus that is dropping off, or picking up, passengers; or
 - (b) the driver—
 - (i) stops in a parking bay; and
 - (ii) is permitted to stop in the parking bay under this regulation.

Maximum penalty—20 penalty units.

- (2) A driver must not stop on or across a driveway or other way of access for vehicles travelling to or from adjacent land unless—
- (a) the driver—
 - (i) is dropping off or picking up passengers; and
 - (ii) does not leave the vehicle unattended; and
 - (iii) completes the dropping off or picking up of the passengers, and drives on, as soon as practicable and, in any case, within 2 minutes after stopping; or
 - (b) the driver—
 - (i) stops in a parking bay; and
 - (ii) is permitted to stop in the parking bay under this regulation.

Maximum penalty—20 penalty units.

[s 199]

- (3) For subsection (2)(a)(ii), a driver leaves a vehicle unattended if the driver is more than 3m from the closest part of the vehicle.

Example—

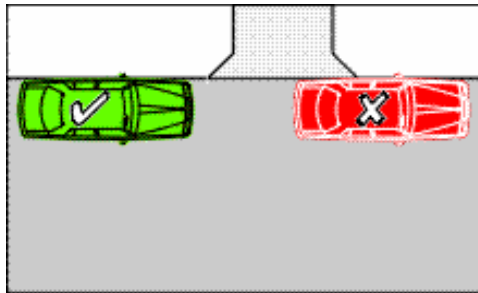

Blocking a driveway

In the example, the vehicle marked with an 'X' is stopped in contravention of subsection (2).

199 Stopping near a postbox

A driver must not stop on a road within 3m of a public postbox unless—

- (a) the driver is dropping off, or picking up, passengers or mail; or
- (b) the driver—
 - (i) stops at a place on a length of road, or in an area, to which a parking control sign applies; and
 - (ii) is permitted to stop at that place under this regulation.

Maximum penalty—20 penalty units.

200 Stopping on roads—heavy and long vehicles

- (1) The driver of a heavy vehicle, or long vehicle, must not stop on a length of road that is not in a built-up area, except on the shoulder of the road.

Maximum penalty—20 penalty units.

- (2) Subject to subsections (2A) and (2B), the driver of a heavy vehicle, or long vehicle, must not stop on a length of road in a built-up area for longer than 1 hour, unless the driver is permitted to stop on the length of road for longer than 1 hour by information on or with a traffic control device.

Maximum penalty—20 penalty units.

- (2A) The driver of a heavy vehicle, or long vehicle, may stop on a length of road in a built-up area for longer than 1 hour if the driver is engaged in dropping off or picking up goods for all of the period when the vehicle is stopped.

- (2B) Subsections (2) and (2A) apply unless a local law otherwise provides.

- (3) In this section—

heavy vehicle means a vehicle with a GVM of 4.5t or more.

long vehicle means a vehicle that, together with any load or projection, is 7.5m long, or longer.

road does not include a road-related area, but includes any shoulder of a road.

201 Stopping on a road with bicycle parking sign

A driver (except the rider of a bicycle) must not stop on a length of road to which a bicycle parking sign applies, unless the driver is dropping off, or picking up, passengers.

Maximum penalty—20 penalty units.

[s 202]

Example—



Bicycle parking sign

202 Stopping on a road with motorbike parking sign

A driver (except the rider of a motorbike) must not stop on a length of road to which a motorbike parking sign applies, unless the driver is dropping off, or picking up, passengers.

Maximum penalty—20 penalty units.

Example—



Motorbike parking sign

203 Stopping in a parking area for people with disabilities

- (1) A driver must not stop in a parking area for people with disabilities unless—
 - (a) the driver's vehicle displays a current parking permit for people with disabilities; and

- (b) the driver complies with the conditions of use of the permit.

Maximum penalty—20 penalty units.

- (2) A ***parking area for people with disabilities*** is a length or area of a road—
 - (a) to which a permissive parking sign displaying a people with disabilities symbol applies; or
 - (b) to which a people with disabilities parking sign applies; or
 - (c) indicated by a road marking (a ***people with disabilities road marking***) that consists of, or includes, a people with disabilities symbol.

Examples—



People with disabilities symbols



Permissive parking sign displaying a people with disabilities symbol (for a length of road)



Permissive parking sign displaying a people with disabilities symbol (for an area)

[s 203A]



People with disabilities parking sign

203A Stopping in a slip lane

A driver must not stop in a slip lane unless—

- (a) a parking control sign applies to the place where the driver stops; and
- (b) the driver is permitted to stop at the place under this regulation.

Maximum penalty—20 penalty units.

Division 7 Permissive parking signs and parking fees

204 Meaning of particular information on or with permissive parking signs

- (1) This section explains the meaning of certain information on or with a permissive parking sign applying to a length of road or an area.

Examples—



Permissive parking sign (for a length of road)



Permissive parking sign (for an area)



Permissive parking sign (for a length of road)

- (2) A whole number, fraction, or whole number and fraction, immediately to the left of the letter 'P' indicates that a driver must not park on the length of road, or in the area, continuously for longer than the period of hours, or fraction of an hour, equal to the number, fraction, or number and fraction, shown.

[s 204]

Examples of permissive parking signs showing permitted parking periods and times of operation—



Example 1

Permissive parking sign applying to a length of road with a whole number to the left of P

In example 1, the sign indicates that a driver must not park continuously for longer than 1 hour on Saturdays between 9a.m. and midday.

In example 2, the sign indicates that, unless permitted by information on or with another traffic control device, a person must not park in the area for longer than 2 hours on—

Mondays to Fridays between 8.30a.m. and 5p.m.

Saturdays between 8.30a.m. and midday.

- (3) A number, together with the word ‘minute’, immediately to the right of the letter ‘P’ indicates that a driver must not park on the length of road, or in the area, continuously for longer than the number of minutes shown.

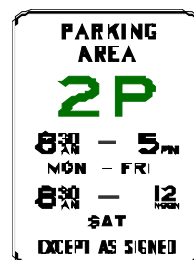

Example 2

Permissive parking sign applying to an area with a whole number to the left of P

Example—



Example 3

Permissive parking sign with a number of minutes to the right of P

In this example, the sign indicates that a driver must not park continuously for longer than 5 minutes between 9a.m. and 4p.m. on Mondays to Fridays.

- (4) The word ‘parking’, together with words indicating a number of hours or minutes, indicates that a driver must not park on the length of road, or in the area, continuously for longer than the number of hours or minutes shown.

205 Parking for longer than indicated

- (1) A driver must not park continuously on a length of road, or in an area, to which a permissive parking sign applies for longer than—
- (a) the period indicated by information on or with the sign; or
 - (b) if section 206 applies to the driver—the period permitted under that section.

Maximum penalty—20 penalty units.

- (1A) If a permissive parking sign does not indicate a period and does not indicate that it applies at particular times, or at particular times on particular days, a driver may, at any time, park continuously on a length of road, or in an area, to which the sign applies, unless—
- (a) another parking control sign applies to the length of road or area; and

[s 205A]

- (b) the driver is prohibited from parking on the length of road, or in the area, under this regulation.
- (2) For subsection (1), a driver parks continuously on a length of road, or in an area, to which a permissive parking sign applies from the time when the driver parks on the length of road or in the area until the driver or another driver moves the vehicle off the length of road or out of the area.

205A Parking outside times indicated

If a permissive parking sign indicates that it applies at particular times, or at particular times on particular days, a driver may park on the length of road, or in an area, to which the sign applies at a time, or at a time on a day, when the sign does not apply, unless—

- (a) another parking control sign applies to the length of road or area; and
- (b) the driver is prohibited from parking on the length of road, or in the area, at that time, or at that time on that day, under this regulation.

206 Time extension for people with disabilities

- (1) This section applies to a driver if—
- (a) the driver's vehicle displays a current parking permit for people with disabilities; and
 - (b) the driver complies with the conditions of use of the permit.
- (2) The driver may park continuously on a length of road, or in an area, to which a permissive parking sign applies—
- (a) if the time limit on the sign is less than 30 minutes—for 30 minutes; or
 - (b) if the time limit on the sign is 30 minutes or more—for an unlimited time.

207 Section number not used

Division 8 Parallel parking

208 Parallel parking on a road (except in a median strip parking area)

- (1) A driver who parks on a road (except in a median strip parking area) must position the driver's vehicle in accordance with subsections (2) to (8).

Maximum penalty—20 penalty units.

- (2) The driver must position the vehicle to face—
- (a) in the direction of travel of vehicles in the marked lane or line of traffic on, or next to, the part of the road where the driver parks; or
 - (b) if there is no traffic on, or next to, the part of the road—in the direction in which vehicles ordinarily travel on, or next to, the part of the road.
- (3) If the road is a two-way road, the driver must position the vehicle parallel, and as near as practicable, to the far left side of the road.
- (4) If the road is a one-way road, the driver must position the vehicle parallel, and as near as practicable, to the far left or far right side of the road, unless otherwise indicated by information on or with a parking control sign.
- (5) If the driver does not park in a parking bay, the driver must position the vehicle at least 1m from the closest point of any vehicle in front of it and any vehicle behind it.
- (6) If the road has a continuous dividing line or a dividing strip, the driver must position the vehicle at least 3m from the continuous dividing line or dividing strip, unless otherwise indicated by information on or with a parking control sign.
- (7) If the road does not have a continuous dividing line or a dividing strip, the driver must position the vehicle so there is at least 3m of the road alongside the vehicle that is clear for

[s 208]

other vehicles to pass, unless otherwise indicated by information on or with a parking control sign.

- (8) The driver must position the vehicle so the vehicle does not unreasonably obstruct the path of other vehicles or pedestrians.
- (9) This section does not apply to—
 - (a) a driver if the driver parks on a length of road, or in an area, to which a parking control sign or road marking applies, and information on or with the sign or road marking includes the words ‘angle parking’ or ‘angle’; or
 - (b) the rider of a motorbike if the rider parks the motorbike on a length of road, or in an area, to which a permissive parking sign applies and the sign indicates that the length of road or area is for parking motorbikes.
- (10) Subsections (3) and (4) do not apply to the rider of a motorbike if the rider positions the motorbike so at least 1 wheel is as near as practicable to the far left or far right side of the road.
- (11) If a road has 1 or more service roads, the part of the road used by the main body of moving vehicles, and each service road, is taken to be a separate road for this section.
- (12) In this section—

continuous dividing line means—

 - (a) a single continuous dividing line only; or
 - (b) a single continuous dividing line to the left or right of a broken dividing line; or
 - (c) 2 parallel continuous dividing lines.

road does not include a road-related area, but includes any shoulder of the road.

Example—

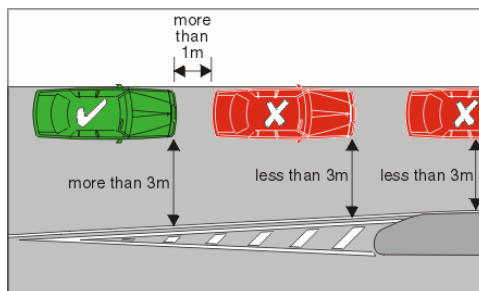

Parallel parking—minimum distance from other vehicles and dividing strip

In the example, the vehicles marked with an ‘X’ are parked in contravention of this section.

208A Parallel parking in a road-related area (except in a median strip parking area)

- (1) A driver who parks in a road-related area (except in a median strip parking area) must position the driver’s vehicle to face—
 - (a) in the direction of travel of vehicles in the marked lane or line of traffic next to the part of the road-related area where the driver parks; or
 - (b) if there is no traffic next to that part of the road-related area—in the direction in which vehicles could lawfully travel in the road-related area; or
 - (c) if the road-related area is an area that divides a road—either—
 - (i) in the direction of travel of vehicles in the marked lane or line of traffic to the left of the driver; or
 - (ii) if there is no traffic to the left of the driver—in the direction in which vehicles could lawfully travel on that part of the road.

[s 209]

Maximum penalty—20 penalty units.

- (2) Subsection (1) does not apply if signs or road markings indicate that angle parking is required in the road-related area.

209 Parallel parking in a median strip parking area

- (1) This section applies to a driver who parks in a median strip parking area if a parking control sign or road marking applies to the area, and information on or with the sign or road marking indicates that the driver's vehicle must be positioned parallel to the median strip.
- (2) The driver must position the driver's vehicle—
 - (a) to face—
 - (i) in the direction of travel of vehicles in the marked lane or line of traffic to the left of the driver; or
 - (ii) if there is no traffic to the left of the driver—in the direction in which vehicles ordinarily travel on the part of the road to the left of the driver; and
 - (b) parallel, and as near as practicable, to the centre of the median strip; and
 - (c) if the driver does not park in a parking bay—at least 1m from the closest point of any vehicle in front of it and any vehicle behind it.

Maximum penalty—20 penalty units.

- (3) This section does not apply to the rider of a motorbike.

Division 9 Angle parking

210 Angle parking

- (1) If a driver parks in a parking area on the side of a road, or in a median strip parking area, to which a parking control sign or road marking applies, and information on the sign includes the words 'angle parking' or 'angle', or the road marking

indicates a particular angle for parking, the driver must position the driver's vehicle in accordance with subsections (2) to (4).

Maximum penalty—20 penalty units.

- (2) If the parking control sign or road marking indicates that the vehicle must be positioned at a stated angle, other than 90°, the driver must position the vehicle—
 - (a) at an angle as near as practicable to the stated angle; and
 - (b) if the vehicle is parked on the side of the road—with the rear of the vehicle nearest to the centre of the road.
- (2A) If the parking control sign or road marking does not indicate an angle at which the vehicle must be positioned, the driver must position the vehicle—
 - (a) at an angle as near as practicable to 45°, as shown in example 1 or 2; and
 - (b) if the vehicle is parked on the side of the road—with the rear of the vehicle nearest to the centre of the road.

[s 210]

Examples—

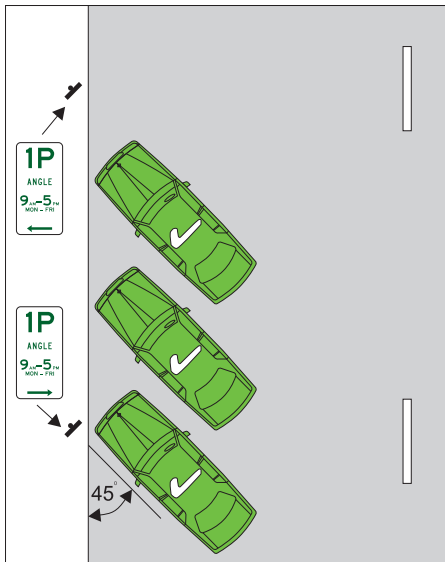

Example 1

Parking at 45° at the side of a two-way road

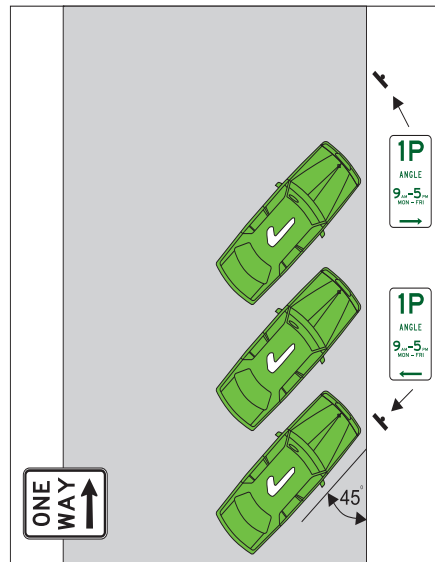

Example 2

Parking at 45° at the side of a one-way road

- (2B) Subsections (2) and (2A) do not apply if the road marking or information on the parking control sign includes the words ‘rear in’, or similar words.
- (3) If the parking control sign or road marking indicates that the vehicle must be positioned at an angle of 90°, the driver—
- (a) must position the driver’s vehicle so the vehicle is at an angle as near as practicable to 90°, as shown in example 3 or 4; and
 - (b) if the vehicle is parked on the side of the road—
 - (i) if the road marking, or information on the sign, includes the words ‘rear in’, or similar words—must position the vehicle with the front of the vehicle nearest to the centre of the road; or

- (ii) if the road marking, or information on the sign, includes the words ‘front in’ or similar words—must position the vehicle with the rear of the vehicle nearest to the centre of the road; or
- (iii) otherwise—may position the vehicle with either the front or rear of the vehicle nearest to the centre of the road.

Examples—

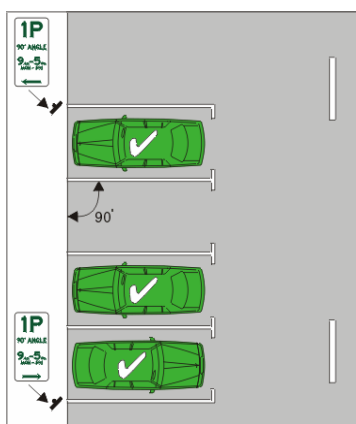

Example 3

Parking at 90° at the side of a two-way road

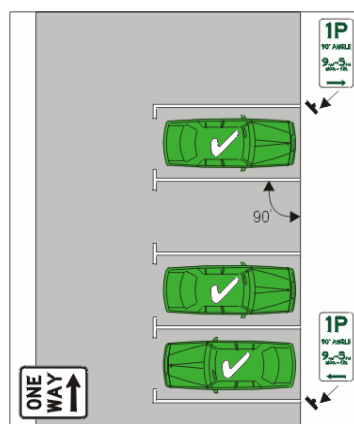

Example 4

Parking at 90° at the right side of a one-way road

- (4) If the road marking, or information on the parking control sign, includes the words ‘rear in’, or similar words, the driver must position the vehicle—
 - (a) at an angle as near as practicable to—
 - (i) if the road marking or sign indicates that the vehicle must be positioned at a stated angle—the stated angle; or
 - (ii) if the road marking or sign does not indicate an angle at which the vehicle must be positioned—45°; and

[s 210]

- (b) if the vehicle is parked on the side of the road—with the front of the vehicle nearest to the centre of the road.

Examples—

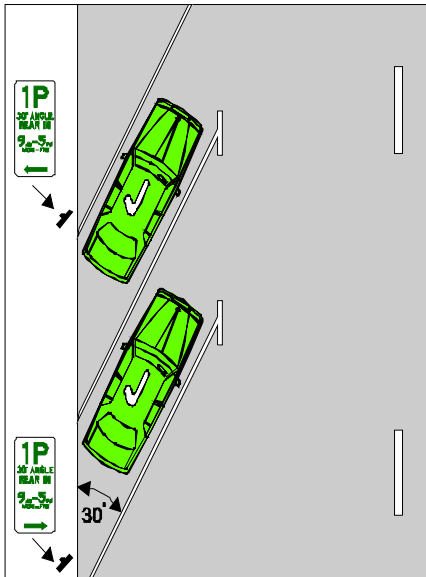

Example 5
Parking rear in at 30° at the side of a road

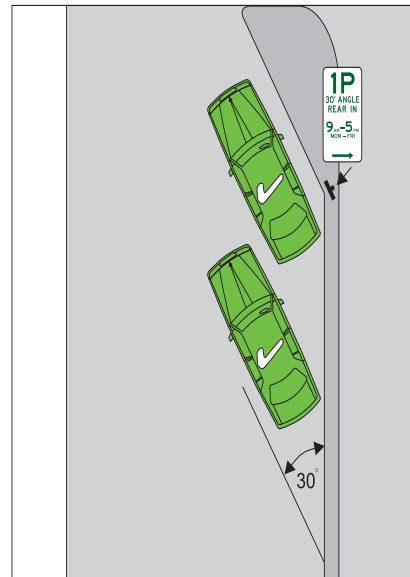

Example 6
Parking rear in at 30° in a median strip parking area

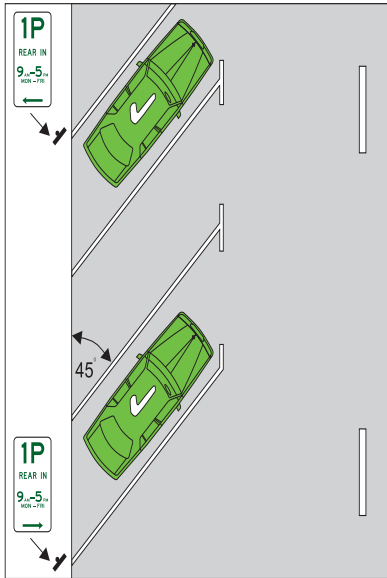

Example 7
Parking rear in at 45° at the side of a road

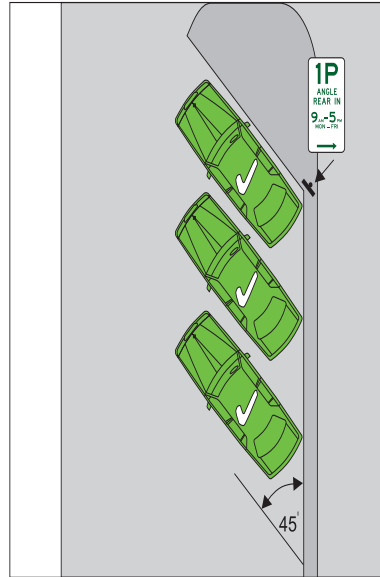

Example 8
Parking rear in at 45° in a median strip parking area

[s 211]

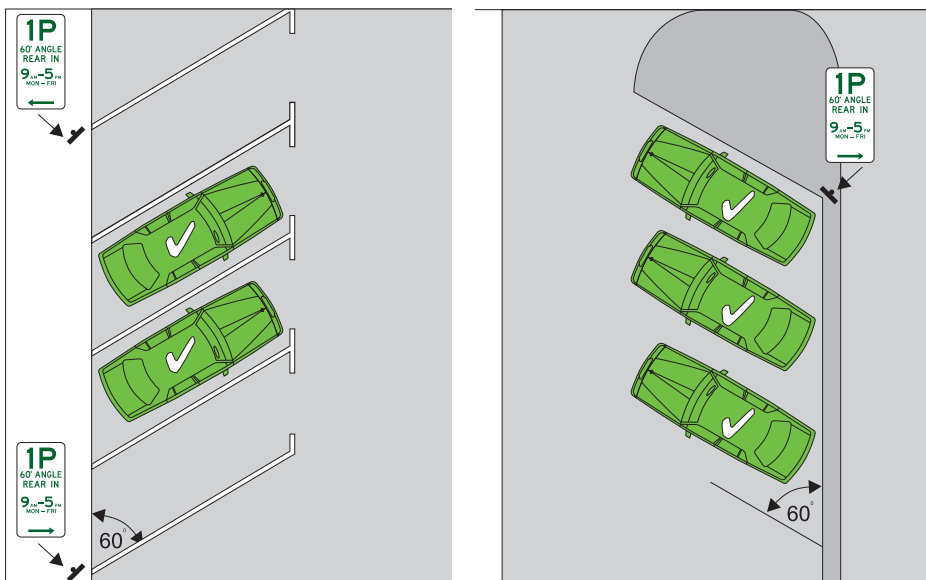

Example 9

Parking rear in at 60° at the side of a road

Example 10

Parking rear in at 60° in a median strip parking area

- (4A) Subsection (4) does not apply if the parking sign or road marking indicates that the vehicle must be positioned at an angle of 90°.
- (5) This section does not apply to the rider of a motorbike.

Division 10 Other parking related rules

211 Parking in parking bays

- (1) This section applies to a driver who parks on a length of road, or in an area, that has parking bays (whether or not a park in bays only sign applies to the length of road or area).

Example—



Park in bays only sign

- (2) The driver must position the driver's vehicle completely within a single parking bay, unless the vehicle is too wide or long to fit completely within the bay.

Maximum penalty—20 penalty units.

- (3) If the vehicle is too wide or long to fit completely within a single parking bay, the driver must park the driver's vehicle within the minimum number of parking bays needed to park the vehicle.

Maximum penalty—20 penalty units.

212 Entering and leaving a median strip parking area

- (1) If information on or with a traffic control device indicates that a driver must enter or leave a median strip parking area in a particular direction, the driver must enter or leave the area in that direction.

Maximum penalty—20 penalty units.

- (2) If there is no information on or with a traffic control device that indicates that a driver must enter or leave a median strip parking area in a particular direction, the driver must enter or leave the area by driving forward.

Maximum penalty—20 penalty units.

[s 213]

Example—

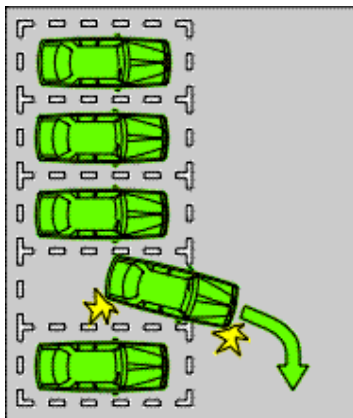

Leaving median strip parking area by driving forward

213 Making a motor vehicle secure

- (1) This section applies to the driver of a motor vehicle who stops and leaves the vehicle on a road, unless the driver need not comply with the section under another provision of this regulation.
- (2) Before leaving the vehicle, the driver must—
 - (a) apply the vehicle's parking brake effectively; or
 - (b) if weather conditions, for example, snow, prevent the effective operation of the parking brake—effectively restrain the vehicle's movement in another way.

Maximum penalty—20 penalty units.

- (3) Also, before leaving the vehicle the driver must switch off the engine if the driver will be more than 3m from the closest part of the vehicle.

Maximum penalty—20 penalty units.

-
- (4) In addition, before leaving the vehicle the driver must remove the ignition key if there is no-one 16 years or older remaining in the vehicle.

Maximum penalty—20 penalty units.

- (5) If the driver will be over 3m from the closest part of the vehicle and there is no-one left in the vehicle, the driver must—
- (a) if the windows of the vehicle can be secured—secure the windows immediately before leaving the vehicle; and
 - (b) if the doors of the vehicle can be locked—lock the doors immediately after leaving the vehicle.

Maximum penalty—20 penalty units.

- (6) For subsection (5), a window is secure even if it is open by up to 50mm.
- (7) Subsections (3) to (5) do not apply to—
- (a) the driver of a waste management vehicle while emptying or collecting wheelie bins; or
 - (b) the driver of an armoured vehicle while on duty.

213A Evidentiary provision

For this part, evidence that a vehicle was found stationary at a place is evidence that the vehicle was parked or stopped at the place.

[s 214]

Part 13 Lights and warning devices

Division 1 Lights on vehicles (except bicycles, animals and animal-drawn vehicles)

214 Division does not apply to riders of bicycles, animals or animal-drawn vehicles

This division does not apply to the rider of a bicycle, animal or animal-drawn vehicle.

215 Using lights when driving at night or in hazardous weather conditions

- (1) A driver must not drive at night, or in hazardous weather conditions causing reduced visibility unless—
 - (a) the headlights, tail-lights and number plate light fitted to the driver's vehicle are operating effectively and are clearly visible; and
 - (b) if the vehicle is fitted with clearance lights or side marker lights—those lights are operating effectively and are clearly visible.

Maximum penalty—20 penalty units.

- (2) However, this section does not apply to a driver if—
 - (a) the driver's vehicle is stopped or parked at a place on a length of road, or in an area, to which a parking control sign applies; and
 - (b) the driver is permitted to stop or park at that place under this regulation.
- (3) Also, a driver driving during the day in fog, or other hazardous weather conditions causing reduced visibility, may drive without the headlights of the driver's vehicle operating if the vehicle is fitted with front fog lights and those lights are operating effectively and are clearly visible.

-
- (4) In subsection (1), a reference to a kind of light fitted to a vehicle is a reference to a light of that kind required to be fitted under—
- (a) the heavy vehicle standards under the Heavy Vehicle National Law (Queensland); or
 - (b) the Standards and Safety Regulation.

216 Towing a vehicle at night or in hazardous weather conditions

- (1) A driver must not tow a vehicle at night, or in hazardous weather conditions causing reduced visibility, unless—
- (a) if the towed vehicle is being towed from the front of the vehicle—
 - (i) the tail-lights of the vehicle are operating effectively and are clearly visible; or
 - (ii) the vehicle has portable rear lights that are operating; or
 - (b) if the towed vehicle is being towed from the rear of the vehicle—the vehicle has portable rear lights that are operating.

Maximum penalty—20 penalty units.

- (2) However, this section does not apply to the driver of a tow truck if—
- (a) the driver is towing a disabled vehicle carrying a placard load of dangerous goods to a place that is safely off the road; and
 - (b) a vehicle carrying a warning to other traffic is following immediately behind the disabled vehicle.
- (3) In this section—

dangerous goods has the meaning given by the *Transport Operations (Road Use Management—Dangerous Goods) Regulation 2008*.

[s 217]

placard load has the meaning given by the *Transport Operations (Road Use Management—Dangerous Goods) Regulation 2008*.

portable rear lights means—

- (a) for a vehicle being towed from the front of the vehicle—a pair of lights attached to the rear of the vehicle that, when operating, show a red light that is clearly visible for at least 200m from the rear of the vehicle; or
- (b) for a vehicle being towed from the rear of the vehicle—a pair of lights attached to the front of the vehicle that, when operating, show a red light that is clearly visible for at least 200m from the front of the vehicle.

road does not include a road-related area, but includes any shoulder of the road.

217 Using fog lights

- (1) The driver of a vehicle fitted with a front fog light or rear fog light must not operate the fog light unless the driver is driving in fog or other hazardous weather conditions causing reduced visibility.

Maximum penalty—20 penalty units.

- (2) In this section—

front fog light means a light (other than a headlight) fitted to the front of a vehicle to improve illumination of the road in fog, snowfall, heavy rain or dust clouds.

rear fog light means a light (other than a brake light, a tail-light, a number plate light or a reversing light) fitted to the rear of a vehicle to make the vehicle more easily visible from the rear in fog, snowfall, heavy rain or dust clouds.

218 Using headlights on high-beam

- (1) The driver of a vehicle must not use the vehicle's headlights on high-beam, or allow the vehicle's headlights to be used on high-beam, if the driver is driving—
 - (a) less than 200m behind a vehicle travelling in the same direction as the driver; or
 - (b) less than 200m from an oncoming vehicle.

Maximum penalty—20 penalty units.

- (2) However, if the driver is overtaking a vehicle, the driver may briefly switch the headlights from low-beam to high-beam immediately before the driver begins to overtake the vehicle.

Examples—

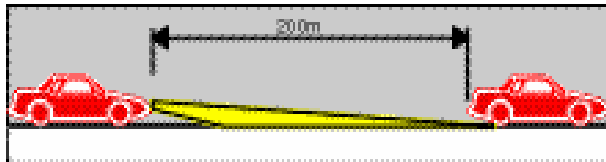

Example 1

Using headlights on low-beam when travelling less than 200m behind another vehicle travelling in the same direction

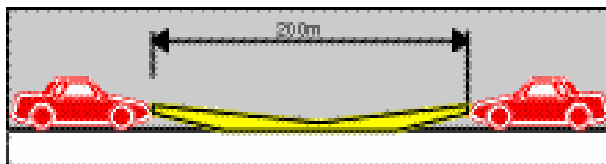

Example 2

Using headlights on low-beam when travelling within 200m of an oncoming vehicle

[s 219]

219 Lights not to be used to dazzle other road users

A driver must not use, or allow to be used, any light fitted to or in the driver's vehicle to dazzle, or in a way that is likely to dazzle, another road user.

Maximum penalty—20 penalty units.

220 Using lights on vehicles that are stopped

- (1) A driver must not stop on a road at night unless—
 - (a) if the driver's vehicle is 2.2m wide, or wider—the clearance and side marker lights fitted to the vehicle are operating effectively and are clearly visible; or
 - (b) in any other case—the parking lights fitted to the driver's vehicle are operating effectively and are clearly visible.

Maximum penalty—20 penalty units.

- (2) This section does not apply to a driver if the driver stops on a length of road, or in an area, with street lighting and the driver's vehicle is visible for at least 200m in all directions from the vehicle.
- (3) In subsection (1), a reference to a kind of light fitted to a vehicle is a reference to a light of that kind required to be fitted under—
 - (a) the heavy vehicle standards under the Heavy Vehicle National Law (Queensland); or
 - (b) the Standards and Safety Regulation.
- (4) In this section—

road does not include a road-related area, but includes any shoulder of the road.

221 Using hazard warning lights

The driver of a vehicle fitted with hazard warning lights must not use the hazard warning lights, or allow them to be used, unless—

- (a) the vehicle is stopped and is obstructing, or is likely to obstruct, the path of other vehicles or pedestrians; or
- (b) the vehicle is a slow-moving vehicle and is obstructing, or is likely to obstruct, the path of other vehicles or pedestrians; or
- (c) the vehicle is stopped in an emergency stopping lane; or
- (d) the driver stops the vehicle to sell a product (for example, ice creams) that may attract children onto the road; or
- (e) the driver is driving in hazardous weather conditions (for example, fog or smoke); or
- (f) the hazard warning lights are operating as part of an anti-theft device, or an alcohol ignition interlock, fitted to the vehicle.

Maximum penalty—20 penalty units.

222 School bus not to be driven without warning lights and warning signs

- (1) A person must not drive a school bus unless it is fitted with warning signs and warning lights under the passenger transport standard, schedule 1, section 19.

Maximum penalty—20 penalty units.

- (2) Subsection (1) does not apply to a school bus that is a heavy vehicle.

222A Use of warning lights—picking up or setting down school children

- (1) This section applies to the driver of a vehicle, whether or not a school bus, fitted with warning lights and warning signs under

[s 222A]

the passenger transport standard, schedule 1, section 19 or 25(1) or the *Heavy Vehicle (Vehicle Standards) National Regulation*, schedule 2, section 76.

- (2) The driver must—
- (a) if the driver intends to stop to pick up or set down children—signal that intention by simultaneously activating the warning lights, at least 5 seconds before the bus stops, unless the warning lights are already operating under the passenger transport standard, schedule 1, section 24(3) or the *Heavy Vehicle (Vehicle Standards) National Regulation*, schedule 2, section 77(3); and
 - (b) keep the warning lights activated until at least 5 seconds after the vehicle has started to move off after stopping.

Maximum penalty—20 penalty units.

- (3) The driver must ensure the warning lights are not activated, other than under subsection (2), the passenger transport standard, schedule 1, section 24(3) or the *Heavy Vehicle (Vehicle Standards) National Regulation*, schedule 2, section 77(3), while the vehicle is on a road, unless the driver has a reasonable excuse.

Example—

The driver is testing the lights to ensure their satisfactory operation.

Maximum penalty—20 penalty units.

- (4) This section applies despite the requirement under the passenger transport standard, schedule 1, section 24(3) or the *Heavy Vehicle (Vehicle Standards) National Regulation*, schedule 2, section 77(3) that the vehicle be fitted with automatically operating warning lights.

Division 2 Lights on animal-drawn vehicles

223 Using lights when riding an animal-drawn vehicle at night or in hazardous weather conditions

A person must not ride an animal-drawn vehicle at night, or in hazardous weather conditions causing reduced visibility, unless the vehicle is fitted with, and displays—

- (a) a white light fitted at or towards the front of each side of the vehicle that is clearly visible for at least 200m from the front of the vehicle; and
- (b) a red light fitted at or towards the rear of each side of the vehicle that is clearly visible for at least 200m from the rear of the vehicle; and
- (c) a red reflector fitted at or towards the rear of each side of the vehicle that is—
 - (i) not over 1.5m above ground level; and
 - (ii) clearly visible for at least 50m from the rear of the vehicle when light is projected onto it by another vehicle's headlight on low-beam.

Maximum penalty—20 penalty units.

Division 3 Horns and radar detectors

224 Using horns and similar warning devices

A driver must not use, or allow to be used, a horn, or similar warning device, fitted to or in the driver's vehicle unless—

- (a) it is necessary to use the horn, or warning device, to warn other road users or animals of the approach or position of the vehicle; or
- (b) the horn, or warning device, is being used as part of an anti-theft device, or an alcohol ignition interlock, fitted to the vehicle.

[s 225]

Maximum penalty—20 penalty units.

225 Using radar detectors and similar devices

- (1) A person must not drive a vehicle if the vehicle, or a trailer being towed by the vehicle, has in or on it—
 - (a) a device for preventing the effective use of a speed measuring device; or
 - (b) a device for detecting the use of a speed measuring device.

Maximum penalty—40 penalty units.

- (2) A person who is travelling in or on a vehicle or trailer must not have in the person's possession a device for preventing the effective use of a speed measuring device, or a device for detecting the use of a speed measuring device.

Maximum penalty—40 penalty units.

- (3) Subsections (1) and (2) apply whether or not the device is operating or in working order.

Division 4 Portable warning triangles for heavy vehicles

226 Heavy vehicles to be equipped with portable warning triangles

A person must not drive a vehicle with a GVM over 12t unless the vehicle is equipped with at least 3 portable warning triangles.

Maximum penalty—20 penalty units.

227 Using portable warning triangles

- (1) This section applies to a driver if the GVM of the driver's vehicle is over 12t.

-
- (2) If the driver stops on a road, or if some or all of any load being carried by the vehicle falls onto a road, at a place where the speed limit is 80km/h or more and the vehicle is not visible at any time for at least 300m in all directions from that place, the driver must use at least 3 portable warning triangles, placed in accordance with subsection (4), to warn other road users of the vehicle or load.

Maximum penalty—20 penalty units.

- (3) If the driver stops on a road, or if some or all of any load being carried by the vehicle falls onto a road, at a place where the speed limit is less than 80km/h and the vehicle is not visible at any time for at least 200m in all directions from that place, the driver must use at least 3 portable warning triangles, placed in accordance with subsection (5), to warn other road users of the vehicle or load.

Maximum penalty—20 penalty units.

- (4) For subsection (2), the driver must—
- (a) place 1 triangle at least 200m, but not over 250m, behind the vehicle or fallen load; and
 - (b) if the vehicle or fallen load is on a one-way road or divided road, place 1 triangle between the triangle mentioned in paragraph (a) and the vehicle or fallen load; and
 - (c) if the vehicle or fallen load is not on a one-way road or divided road, place 1 triangle at least 200m, but not over 250m, in front of the vehicle or fallen load; and
 - (d) place 1 triangle at the side of the vehicle, or fallen load, in a position that gives sufficient warning to other road users of the position of the vehicle or fallen load.
- (5) For subsection (3), the driver must—
- (a) place 1 triangle at least 50m, but not over 150m, behind the vehicle or fallen load; and
 - (b) if the vehicle or fallen load is on a one-way road or divided road, place 1 triangle between the triangle

[s 227A]

mentioned in paragraph (a) and the vehicle or fallen load; and

- (c) if the vehicle or fallen load is not on a one-way or divided road, place 1 triangle at least 50m, but not over 150m, in front of the vehicle or fallen load; and
 - (d) place 1 triangle at the side of the vehicle, or fallen load, in a position that gives sufficient warning to other road users of the position of the vehicle or fallen load.
- (6) In this section—

divided road means any length of a two-way road that has a median strip that is a structure.

road does not include a road-related area, but includes any shoulder of a road.

Division 5 Signs for oversize vehicles

227A Do not overtake turning vehicle signs for long vehicles

A person must not drive a vehicle displaying a do not overtake turning vehicle sign if the vehicle, together with any load or projection, is not 7.5m long, or longer.

Maximum penalty—20 penalty units.

227B Warning sign not to be displayed if not required by law

A person must not drive a vehicle displaying an oversize warning sign unless—

- (a) the person is required under the Act or another Act to display the sign; or
- (b) the vehicle is temporarily in Queensland on a journey from another State and the sign must be displayed on the vehicle under the law of the other State.

Maximum penalty—20 penalty units.

Part 14 Rules for pedestrians

Division 1 General

228 No pedestrian signs

A pedestrian must not travel past a no pedestrians sign.

Maximum penalty—20 penalty units.

Example—



No pedestrians sign

229 Pedestrians on a road with a road access sign

A pedestrian must not be on a length of road to which a road access sign applies if information on or with the sign indicates that pedestrians are not permitted beyond the sign.

Maximum penalty—20 penalty units.

Example—



Road access sign

[s 230]

230 Crossing a road—general

- (1) A pedestrian crossing a road—
 - (a) must cross by the shortest safe route; and
 - (b) must not stay on the road longer than necessary to cross the road safely.

Maximum penalty—20 penalty units.

- (2) However, if the pedestrian is crossing the road at an intersection with traffic lights and a pedestrians may cross diagonally sign, the pedestrian may cross the road diagonally at the intersection.
- (3) In this section—

road does not include a road-related area, but includes any shoulder of the road.

Example—



Pedestrians may cross diagonally sign

231 Crossing a road at pedestrian lights

- (1) A pedestrian approaching or at an intersection, or another place on a road, with pedestrian lights and traffic lights must comply with this section.

Maximum penalty—20 penalty units.

- (2) If the pedestrian lights show a red pedestrian light and the pedestrian has not already started crossing the intersection or

road, the pedestrian must not start to cross until the pedestrian lights change to green.

- (3) If, while the pedestrian is crossing the road, the pedestrian lights change to flashing red or red, the pedestrian must not stay on the road for longer than necessary to cross safely to the nearer (in the direction of travel of the pedestrian) of the following—
 - (a) a dividing strip, safety zone, or traffic island, forming part of the area set aside or used by pedestrians to cross the road at the intersection or place (the *safety area*);
 - (b) the nearest side of the road.
- (4) If, under subsection (3), the pedestrian crosses to the safety area, the pedestrian must remain in the safety area until the pedestrian lights change to green.
- (5) However, if the pedestrian can not operate the pedestrian lights from the safety area, the pedestrian may cross to the far side of the road when—
 - (a) the traffic lights change to green or flashing yellow, or there is no red traffic light showing; and
 - (b) it is safe to do so.
- (6) In this section—

road does not include a road-related area, but includes any shoulder of the road.

Examples—

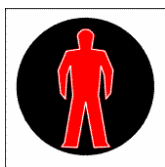

Red pedestrian light showing red pedestrian symbol

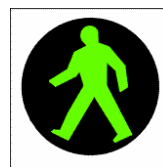

Green pedestrian light showing green pedestrian symbol

[s 232]

232 Crossing a road at traffic lights

- (1) A pedestrian approaching or at an intersection, or another place on a road, with traffic lights, but without pedestrian lights must comply with this section.

Maximum penalty—20 penalty units.

- (2) If the traffic lights show a red or yellow traffic light and the pedestrian has not already started crossing the intersection or road, the pedestrian must not start to cross until—
 - (a) the traffic lights change to green or flashing yellow; or
 - (b) there is no red traffic light showing.
- (3) If, while the pedestrian is crossing the road, the traffic lights change to yellow or red, the pedestrian must not stay on the road for longer than necessary to cross safely to the nearer (in the direction of travel of the pedestrian) of the following—
 - (a) a dividing strip, safety zone, or traffic island, forming part of the area set aside or used by pedestrians to cross the road at the intersection or place (a *safety area*);
 - (b) the far side of the road.
- (3A) Despite subsection (3), the pedestrian may instead return to the side of the road, or a safety area, that the pedestrian has just left, but only if—
 - (a) at the time the lights change, that side or safety area is closer to the pedestrian than the side or safety area the pedestrian was approaching at the time; and
 - (b) the pedestrian does not stay on the road for longer than is necessary to return to that side or safety area.
- (4) If, under subsection (3) or (3A), the pedestrian crosses, or returns, to a safety area, the pedestrian must remain in the safety area until—
 - (a) the traffic lights change to green or flashing yellow; or
 - (b) there is no red traffic light showing.
- (5) In this section—

road does not include a road-related area, but includes any shoulder of the road.

233 Crossing a road to or from a tram

- (1) A pedestrian must not cross a road to get on a tram at a tram stop until the tram has stopped at the tram stop.

Maximum penalty—20 penalty units.

- (2) A pedestrian crossing a road after getting off a tram—
- (a) must cross to the nearest footpath by the shortest safe route or, if there is no footpath, cross the road by the shortest safe route; and
 - (b) must not stay on the road for longer than necessary to cross the road safely.

Maximum penalty—20 penalty units.

- (3) This section does not apply to a pedestrian—
- (a) on a safety zone; or
 - (b) crossing a road to or from a safety zone.
- (4) Subsection (2) does not apply to—
- (a) a pedestrian in a shared zone; or
 - (b) an employee of a public transport operator who is in uniform and engaged in carrying out the employee's duties.

- (5) In this section—

road does not include a road-related area, but includes any shoulder of the road.

tram includes a bus travelling along tram tracks.

234 Crossing a road on or near a crossing for pedestrians

- (1) A pedestrian must not cross a road, or part of a road, within 20m of a crossing on the road, except at the crossing or another crossing, unless the pedestrian is—

[s 235]

- (a) crossing, or helping another pedestrian to cross, an area of the road between tram tracks and the far left side of the road to get on, or after getting off, a tram or bus; or
- (b) crossing to or from a safety zone; or
- (c) crossing at an intersection with traffic lights and a pedestrians may cross diagonally sign; or
- (d) crossing in a shared zone; or
- (e) crossing a road, or a part of a road, from which vehicles are excluded, either permanently or temporarily.

Maximum penalty—20 penalty units.

- (2) A pedestrian must not stay on a crossing on a road for longer than necessary to cross the road safely.

Maximum penalty—20 penalty units.

- (3) Subsection (2) does not apply to a person who is a crossing supervisor under the Act.
- (4) In this section—

crossing means a children's crossing, marked foot crossing or pedestrian crossing.

Example—



Pedestrians may cross diagonally sign

235 Crossing a level crossing

- (1) A pedestrian must not cross a railway line, or tram tracks, at a level crossing unless—

-
- (a) there is a pedestrian facility at the crossing and the pedestrian uses the facility; or
 - (b) there is no pedestrian facility at, or within 20m of, the crossing.

Maximum penalty—20 penalty units.

- (2) A pedestrian must not cross a railway line, or tram tracks, at a level crossing if—
 - (a) warning lights (for example, twin red lights or rotating red lights) are flashing or warning bells are ringing; or
 - (b) a gate, boom or barrier at the crossing is closed or is opening or closing; or
 - (c) a train or tram is on or entering the crossing; or
 - (d) a train or tram approaching the crossing can be seen from the crossing or is sounding a warning, and there would be a danger of the pedestrian being struck by the train or tram if the pedestrian entered the crossing; or
 - (e) the crossing, or a road beyond the crossing, is blocked.

Example for subsection (2)(e)—

The crossing, or a road beyond the crossing, may be blocked by congested traffic, a disabled vehicle, a collision between vehicles or between a vehicle and a pedestrian, or by stock on the road.

Maximum penalty—20 penalty units.

- (2A) If any of the following events occurs after a pedestrian has started to cross a railway line, or tram tracks, at a level crossing, the pedestrian must finish crossing the line or tracks without delay—
 - (a) warning lights start flashing, or warning bells start ringing;
 - (b) a gate, boom or barrier starts to close;
 - (c) a train or tram approaches the crossing.

Maximum penalty—20 penalty units.

- (3) In this section—

[s 235A]

pedestrian facility means a footpath, bridge or other structure designed for the use of pedestrians.

235A Crossing a pedestrian level crossing that has a red pedestrian light

- (1) A *pedestrian level crossing* is an area where a footpath or shared path crosses a railway or tram tracks at substantially the same level.
- (2) If a pedestrian approaches a pedestrian level crossing that has a red pedestrian light, the pedestrian must not start to cross the crossing while the light is red.

Maximum penalty—20 penalty units.

- (3) If a red pedestrian light at a pedestrian level crossing appears after a pedestrian has started to cross the crossing, the pedestrian must finish crossing the crossing without delay.

Maximum penalty—20 penalty units.

Example—



Red pedestrian light showing red pedestrian symbol

236 Pedestrians not to cause a traffic hazard or obstruction

- (1) A pedestrian must not cause a traffic hazard by moving into the path of a driver.

Maximum penalty—20 penalty units.

- (2) A pedestrian must not unreasonably obstruct the path of any driver or another pedestrian.

Maximum penalty—20 penalty units.

- (3) For subsection (2), a pedestrian does not unreasonably obstruct the path of another pedestrian only by travelling more slowly than other pedestrians.
- (4) A pedestrian must not stand on, or move onto, a road—
 - (a) to solicit contributions, employment or business from an occupant of a vehicle; or
 - (b) to hitchhike; or
 - (c) to display an advertisement; or
 - (d) to sell things or offer things for sale; or
 - (e) to wash or clean, or offer to wash or clean, a vehicle's windscreen.

Maximum penalty—20 penalty units.

- (5) A driver, or a passenger, in or on a vehicle must not buy, or offer to buy, an article or service from a person standing on the road.

Maximum penalty—20 penalty units.

- (6) Subsections (4)(a), (c) and (d) and (5) do not apply to a pedestrian who is engaged in roadside vending under a permit or other authority given to the person under a local law.
- (7) In this section—

road includes a shoulder of a road, a median strip, a painted island or a traffic island, but does not include another road-related area.

237 Getting on or into a moving vehicle

- (1) A person must not get on, or into, a moving vehicle unless—
 - (a) the person is—
 - (i) engaged in the door-to-door delivery or collection of goods, or in the collection of waste or garbage; and

[s 238]

- (ii) required to get in or out of the vehicle, or on or off the vehicle, at frequent intervals; and
 - (b) the vehicle is not travelling at a speed over 5km/h.
Maximum penalty—20 penalty units.
- (2) This section does not apply to a person who is getting on or off a bicycle or animal.

238 Pedestrians travelling along a road (except if using a wheeled recreational device, wheeled toy or personal mobility device)

- (1) A pedestrian must not travel along a road if there is a footpath or nature strip adjacent to the road, unless it is impracticable to travel on the footpath or nature strip.

Maximum penalty—20 penalty units.

- (2) A pedestrian travelling along a road—
- (a) must keep as far to the left or right side of the road as is practicable; and
 - (ab) must, when moving forward, face approaching traffic that is moving in the direction opposite to which the pedestrian is travelling, unless it is impracticable to do so; and
 - (b) must not travel on the road alongside more than 1 other pedestrian or vehicle travelling on the road in the same direction as the pedestrian, unless the pedestrian is overtaking other pedestrians.

Maximum penalty—20 penalty units.

- (3) In this section—
- pedestrian*** does not include a person—
- (a) travelling in or on a wheeled recreational device or wheeled toy; or
 - (b) using a personal mobility device.

Note—

See section 244G about using a personal mobility device for travelling along a road.

road—

- (a) includes any shoulder of the road; but
- (b) does not include a road-related area or a road in a shared zone.

239 Pedestrians on a bicycle path or separated footpath

- (1) A pedestrian must not be on a bicycle path, or a part of a separated footpath designated for the use of bicycles, unless the pedestrian—
 - (a) is crossing the bicycle path or separated footpath by the shortest safe route; and
 - (b) does not stay on the bicycle path or separated footpath for longer than necessary to cross the bicycle path or separated footpath safely.

Maximum penalty—20 penalty units.

- (2) However, a pedestrian may be on a bicycle path, or a part of a separated footpath designated for the use of bicycles, if—
 - (a) the pedestrian is—
 - (i) in or pushing a wheelchair; or
 - (ii) on rollerblades, rollerskates or a similar wheeled recreational device; or
 - (iii) using a personal mobility device; and
 - (b) there is no traffic control device, or information on or with a traffic control device, applying to the bicycle path or separated footpath indicating that the pedestrian is not permitted to be on the bicycle path or the part of the separated footpath designated for the use of bicycles.
- (3) A pedestrian who is crossing a bicycle path, or a part of a separated footpath designated for the use of bicycles, must keep out of the path of any bicycle, or any pedestrian who is

[s 239]

permitted under subsection (2) to be on the bicycle path, or the part of the separated footpath designated for the use of bicycles.

Maximum penalty—20 penalty units.

(4) In this regulation—

bicycle path means a length of path beginning at a bicycle path sign or bicycle path road marking, and ending at the nearest of the following—

- (a) an end bicycle path sign or end bicycle path road marking;
- (b) a separated footpath sign or separated footpath road marking;
- (c) a road (except a road-related area);
- (d) the end of the path.

bicycle path road marking means a road marking on a path, consisting of a bicycle symbol, the words ‘bicycles only’, or both the bicycle symbol and the word ‘only’.

end bicycle path road marking means a bicycle path road marking with the word ‘end’.

end separated footpath road marking means a separated footpath road marking with the word ‘end’.

separated footpath means a length of footpath beginning at a separated footpath sign or separated footpath road marking, and ending at the nearest of the following—

- (a) an end separated footpath sign or end separated footpath road marking;
- (b) a bicycle path sign or bicycle path road marking;
- (c) a no bicycles sign or no bicycles road marking;
- (d) a road (except a road-related area);
- (e) the end of the footpath.

[s 239]

separated footpath road marking means a road marking on a footpath consisting of a pedestrian symbol and a bicycle symbol side by side, with or without the word ‘only’.

Examples—



Bicycle path sign



End bicycle path sign



Separated footpath sign



End separated footpath sign



No bicycles sign

[s 240]

Division 2 **Rules for persons travelling in or on wheeled recreational devices and wheeled toys**

240 **Wheeled recreational devices and toys not to be used on certain roads**

- (1) A person must not travel in or on a wheeled recreational device or wheeled toy on—
 - (a) a road with a dividing line or median strip; or
 - (b) a road on which the speed limit is more than 50km/h; or
 - (c) a one-way road with more than 1 marked lane; or
 - (d) a road at night.

Maximum penalty—20 penalty units.

- (2) Subsection (1) does not apply to a person who is crossing a road in or on a wheeled recreational device or wheeled toy, if the person—
 - (a) crosses the road by the shortest safe route; and
 - (b) does not stay on the road longer than necessary to cross the road safely.

- (3) In this section—

road does not include a road-related area, but includes any shoulder of the road.

240A **No wheeled recreational devices or toys sign**

A person on a road who is travelling in or on a wheeled recreational device or wheeled toy must not travel past a no wheeled recreational devices or toys sign.

Maximum penalty—20 penalty units.

Examples—



No wheeled recreational devices or toys signs

241 Travelling in or on a wheeled recreational device or toy on a road

- (1) A person travelling in or on a wheeled recreational device or wheeled toy on a road—
 - (a) must keep as far to the left side of the road as is practicable; and
 - (b) must not travel alongside more than 1 other pedestrian or vehicle travelling on the road in the same direction as the person, unless the person is overtaking other pedestrians.

Maximum penalty—20 penalty units.

- (2) In this section—

road does not include a road-related area, but, in subsection (1)(b), includes any shoulder of the road.

242 Travelling in or on a wheeled recreational device or toy on a footpath or shared path

- (1) Subject to subsection (1A), a person travelling in or on a wheeled recreational device or wheeled toy on a footpath or shared path must—

[s 242]

- (a) keep to the left of the footpath or shared path unless it is impracticable to do so; and
- (b) give way to any pedestrian (except a person travelling in or on a wheeled recreational device or wheeled toy, or using a personal mobility device) who is on the footpath or shared path.

Maximum penalty—20 penalty units.

- (1A) Subsection (1) does not apply to a person travelling in or on a wheeled recreational device or wheeled toy on a footpath if a local law prohibits the travelling.
- (2) A **shared path** is an area open to the public (except a separated footpath) that is designated for, or has as 1 of its main uses, use by both the riders of bicycles and pedestrians, and includes a length of path for use by both bicycles and pedestrians beginning at a shared path sign, or shared path road marking, and ending at the nearest of the following—
 - (a) an end shared path sign or end shared path road marking;
 - (b) a no bicycles sign or no bicycles road marking;
 - (c) a bicycle path sign or bicycle path road marking;
 - (d) a road (except a road-related area);
 - (e) the end of the path.
- (3) In this section—

end shared path road marking means a shared path road marking that includes the word ‘end’.

shared path road marking means a road marking consisting of a pedestrian symbol above a bicycle symbol.

Examples—



Shared path sign



End shared path sign



No bicycles sign



Bicycle path sign

243 Travelling on rollerblades etc. on a bicycle path or separated footpath

- (1) A person travelling on rollerblades, rollerskates, or a similar wheeled recreational device, must not be on a part of a separated footpath designated for the use of pedestrians unless the person—
 - (a) is crossing the separated footpath by the shortest safe route; and
 - (b) does not stay on the separated footpath for longer than necessary to cross the separated footpath safely.

Maximum penalty—20 penalty units.

- (2) A person travelling on rollerblades, rollerskates, or a similar wheeled recreational device, on a bicycle path, or a part of a

[s 244]

separated footpath designated for the use of bicycles, must keep out of the path of any bicycle.

Maximum penalty—20 penalty units.

244 Wheeled recreational devices or wheeled toys being towed etc.

- (1) A person must not travel in or on a wheeled recreational device or wheeled toy that is being towed by a vehicle.

Maximum penalty—20 penalty units.

- (2) A person travelling in or on a wheeled recreational device or wheeled toy must not hold onto a vehicle while the vehicle is moving.

Maximum penalty—20 penalty units.

- (3) A person travelling in or on a wheeled recreational device or wheeled toy must not travel within 2m of the rear of a moving motor vehicle continuously for more than 200m.

Maximum penalty—20 penalty units.

244A Section number not used

244B Wearing of helmets by users of motorised scooters

- (1) A person who is travelling on a motorised scooter on a road or road-related area must wear an approved bicycle helmet securely fitted and fastened on the person's head.

Maximum penalty—20 penalty units.

- (2) A person is exempt from wearing a bicycle helmet under subsection (1) if the person is carrying a current doctor's certificate stating that, for a stated period—

- (a) the person can not wear a bicycle helmet for medical reasons; or

-
- (b) because of a physical characteristic of the person, it would be unreasonable to require the person to wear a bicycle helmet.
 - (3) A person is also exempt from wearing a bicycle helmet under subsection (1) if—
 - (a) the person is a member of a religious group; and
 - (b) the person is wearing a type of headdress customarily worn by members of the group; and
 - (c) the wearing of the headdress makes it impractical for the person to wear a bicycle helmet.

Division 3 Additional rules for using personal mobility devices

244C Application of pt 14, div 3

This division applies to a person using a personal mobility device (a *PMD user*).

244D Age restrictions for PMD user

A person using a personal mobility device must be—

- (a) at least 16 years; or
- (b) supervised by an adult while using the device if the person is at least 12 years but under 16 years.

Maximum penalty—20 penalty units.

244E Speed limit for device

A person must not use a personal mobility device at a speed over 12km/h.

Maximum penalty—20 penalty units.

[s 244F]

244F PMD user to wear helmet

- (1) A PMD user must wear an approved bicycle helmet securely fitted and fastened on the user's head.

Maximum penalty—20 penalty units.

- (2) A person is exempt from wearing a bicycle helmet under subsection (1) if the person is carrying a current doctor's certificate stating that, for a stated period—

- (a) the person can not wear a bicycle helmet for medical reasons; or
- (b) because of a physical characteristic of the person, it would be unreasonable to require the person to wear a bicycle helmet.

- (3) A person is also exempt from wearing a bicycle helmet under subsection (1) if—

- (a) the person is a member of a religious group; and
- (b) the person is wearing a type of headdress customarily worn by members of the group; and
- (c) the wearing of the headdress makes it impractical for the person to wear a bicycle helmet.

244G PMD user travelling along a road

A PMD user must not travel along a road unless—

- (a) there is an obstruction on a footpath, nature strip, bicycle path or shared path adjacent to the road (an *adjacent area*); and
- (b) it is impracticable to travel on the adjacent area; and
- (c) the PMD user travels less than 50m along the road to avoid the obstruction.

Maximum penalty—20 penalty units.

244H No personal mobility devices sign

A PMD user must not travel past a no personal mobility devices sign.

Maximum penalty—20 penalty units.

Example—



No personal mobility devices sign

244I Using a device on a footpath or shared path

- (1) Subject to subsection (2), a PMD user travelling on a footpath or shared path must—
 - (a) keep to the left of the footpath or shared path unless it is impracticable to do so; and
 - (b) give way to another pedestrian (except another PMD user) who is on the footpath or shared path.

Maximum penalty—20 penalty units.

- (2) Subsection (1) does not apply to a PMD user travelling on a footpath or shared path if a local law prohibits using a personal mobility device on the footpath or shared path.

244J Carrying people on device

A PMD user must not carry any other person on the personal mobility device.

Maximum penalty—20 penalty units.

[s 244K]

244K Travelling to the left of oncoming PMD users or riders on a path

A PMD user on a bicycle path, footpath, separated footpath or shared path must keep to the left of any oncoming bicycle rider or other PMD user on the path.

Maximum penalty—20 penalty units.

244L Warning equipment on device

A person must not use a personal mobility device unless the device has a bell, horn or similar warning device in working order.

Maximum penalty—20 penalty units.

244M Using device at night

A person must not use a personal mobility device at night, or in hazardous weather conditions causing reduced visibility, unless the person, or the device, displays—

- (a) a flashing or steady white light that is clearly visible for at least 200m from the front of the device; and
- (b) a flashing or steady red light that is clearly visible for at least 200m from the rear of the device; and
- (c) a red reflector that is clearly visible for at least 50m from the rear of the device when light is projected onto it by a vehicle's headlight on low-beam.

Maximum penalty—20 penalty units.

244N Bicycle crossing lights provisions also apply to PMD user

Sections 260 to 262 also apply to a PMD user as if the user were the rider of a bicycle.

244O Using mobile phones on device

- (1) A person must not use a mobile phone that the person is holding in the person's hands while the person is using a personal mobility device.

Maximum penalty—20 penalty units.

- (2) In this section—

use, in relation to a mobile phone, includes any of the following—

- (a) holding the phone to, or near, the ear, whether or not engaged in a phone call;
- (b) writing, sending or reading a text message on the phone;
- (c) turning the phone on or off;
- (d) operating any other function of the phone.

244P Drinking liquor while using device

A person must not drink liquor while using a personal mobility device.

Maximum penalty—20 penalty units.

Part 15 Additional rules for bicycle riders

245 Riding a bicycle

The rider of a bicycle must—

- (a) sit astride the rider's seat facing forwards (except if the bicycle is not built to be ridden astride); and
- (b) ride with at least 1 hand on the handlebars; and
- (c) if the bicycle is equipped with a seat—not ride the bicycle seated in any other position on the bicycle.

[s 246]

Maximum penalty—20 penalty units.

246 Carrying people on a bicycle

- (1) The rider of a bicycle must not carry more persons on the bicycle than the bicycle is designed to carry.

Maximum penalty—20 penalty units.

Example—

A single-seat bicycle with a child's seat attached is designed to carry 2 people, 1 on the bicycle seat and 1 on the attached child's seat.

- (2) A passenger on a bicycle that is moving, or is stationary but not parked, must sit in the seat designed for the passenger.

Maximum penalty—20 penalty units.

- (3) The rider of a bicycle must not ride with a passenger unless the passenger complies with subsection (2).

Maximum penalty—20 penalty units.

247B Giving way while entering or in a bicycle storage area

- (1) A rider of a bicycle must when entering a bicycle storage area, give way to—

- (a) any vehicle that is in the area; and
- (b) if the area is before any green or yellow traffic lights, any motor vehicle that is entering or about to enter the area, unless the motor vehicle is turning in a direction that is subject to a red traffic arrow; and
- (c) if the area forms part of a lane to which traffic arrows apply, any motor vehicle that is entering or about to enter the area at a time when those arrows are green or yellow.

Maximum penalty—20 penalty units.

- (2) A rider of a bicycle that is in a bicycle storage area that extends across more than 1 lane of a multi-lane road must, if the area is before any green or yellow traffic lights, give way

to a motor vehicle that is in any lane other than the lane that the bicycle is directly in front of, unless the motor vehicle is turning in a direction that is subject to a red traffic arrow.

Maximum penalty—20 penalty units.

248 Riding across a road on particular crossings

- (1) This section applies to the rider of a bicycle who is at—
 - (a) a children’s crossing; or
 - (b) a marked foot crossing; or
 - (c) a pedestrian crossing.
- (2) The rider may ride across the crossing only in accordance with this section.

Maximum penalty—20 penalty units.

- (3) The rider may ride across a children’s crossing or pedestrian crossing only if the rider stops as near as practicable to the crossing before riding across the crossing.
- (4) The rider may ride across a marked foot crossing only if—
 - (a) for a crossing with bicycle crossing lights—the rider is allowed, under this regulation, to ride across the crossing; or
 - (b) for a crossing without bicycle crossing lights—a pedestrian is allowed, under this regulation, to cross the crossing.

Note—

See sections 260 to 262 for circumstances in which a rider of a bicycle is allowed to cross a road at bicycle crossing lights.

See section 231 for circumstances in which a pedestrian is allowed to cross a road at pedestrian lights.

- (5) The rider may ride across the crossing only if the rider—
 - (a) proceeds slowly and safely; and
 - (b) gives way to a pedestrian on the crossing; and

[s 249]

(c) keeps to the left of an oncoming rider of a bicycle or a person who is using a personal mobility device.

(6) In this section—

pedestrian does not include a person using a personal mobility device.

249 Riding on a separated footpath

The rider of a bicycle must not ride on a part of a separated footpath designated for the use of pedestrians.

Maximum penalty—20 penalty units.

250 Riding on a footpath or shared path

(1) Subject to subsection (1A), the rider of a bicycle riding on a footpath or shared path must—

(a) keep to the left of the footpath or shared path unless it is impracticable to do so; and

(b) give way to any pedestrian on the footpath or shared path.

Maximum penalty—20 penalty units.

(1A) Subsection (1) does not apply to a person riding a bicycle on a footpath if a local law otherwise provides.

(2) In this section—

footpath does not include a separated footpath.

pedestrian does not include a person using a personal mobility device.

251 Riding to the left of oncoming bicycle riders or device users on a path

The rider of a bicycle riding on a bicycle path, footpath, separated footpath or shared path must keep to the left of any oncoming bicycle rider, or person using a personal mobility device, on the path.

Maximum penalty—20 penalty units.

252 No bicycles signs and markings

- (1) The rider of a bicycle must not ride on a length of road or footpath to which a no bicycles sign, or a no bicycles road marking, applies.

Maximum penalty—20 penalty units.

- (2) A no bicycles sign, or a no bicycles road marking, applies to a length of road or footpath beginning at the sign or marking and ending at the nearest of the following—
- (a) a bicycle path sign or bicycle path road marking;
 - (b) a bicycle lane sign;
 - (c) a separated footpath sign or separated footpath road marking;
 - (d) a shared path sign;
 - (e) an end no bicycles sign;
 - (f) the next intersection.

Examples—



No bicycles sign



Bicycle path sign

[s 253]



Bicycle lane sign



Separated footpath sign



Shared path sign



End no bicycles sign

253 Bicycle riders not to cause a traffic hazard

The rider of a bicycle must not cause a traffic hazard by moving into the path of a driver or pedestrian.

Maximum penalty—20 penalty units.

254 Bicycles being towed etc.

- (1) A person must not ride on a bicycle that is being towed by another vehicle.

Maximum penalty—20 penalty units.

- (2) The rider of a bicycle must not hold onto another vehicle while the vehicle is moving.

Maximum penalty—20 penalty units.

255 Riding too close to the rear of a motor vehicle

The rider of a bicycle must not ride within 2m of the rear of a moving motor vehicle continuously for more than 200m.

Maximum penalty—20 penalty units.

256 Bicycle helmets

- (1) The rider of a bicycle must wear an approved bicycle helmet securely fitted and fastened on the rider's head.

Maximum penalty—20 penalty units.

- (2) A passenger on a bicycle that is moving, or is stationary but not parked, must wear an approved bicycle helmet securely fitted and fastened on the passenger's head, unless the passenger is a paying passenger on a three- or four-wheeled bicycle.

Maximum penalty—20 penalty units.

- (3) The rider of a bicycle must not ride with a passenger on the bicycle unless the passenger complies with subsection (2).

Maximum penalty—20 penalty units.

- (4) A person is exempt from wearing a bicycle helmet under subsection (1) or (2) if the person is carrying a current doctor's certificate stating that, for a stated period—

- (a) the person can not wear a bicycle helmet for medical reasons; or
- (b) because of a physical characteristic of the person, it would be unreasonable to require the person to wear a bicycle helmet.

- (5) A person is also exempt from wearing a bicycle helmet under subsection (1) or (2) if—

- (a) the person is a member of a religious group; and
- (b) the person is wearing a type of headdress customarily worn by members of the group; and

[s 257]

- (c) the wearing of the headdress makes it impractical for the person to wear a bicycle helmet.

257 Riding with a person on a bicycle trailer

- (1) The rider of a bicycle must not tow a bicycle trailer with a person in or on the bicycle trailer, unless—
 - (a) the rider is 16 years old, or older; and
 - (b) the person in or on the bicycle trailer is under 10 years old; and
 - (c) the bicycle trailer can safely carry the person; and
 - (d) the person in or on the bicycle trailer is wearing an approved bicycle helmet securely fitted and fastened on the person's head.

Maximum penalty—20 penalty units.

- (1A) A person is exempt from wearing a bicycle helmet if the person is carrying a current doctor's certificate stating that, for a stated period—
 - (a) the person can not wear a bicycle helmet for medical reasons; or
 - (b) because of a physical characteristic of the person, it would be unreasonable to require the person to wear a bicycle helmet.
- (1B) A person is also exempt from wearing a bicycle helmet if—
 - (a) the person is a member of a religious group; and
 - (b) the person is wearing a type of headdress customarily worn by members of the group; and
 - (c) the wearing of the headdress makes it impractical for the person to wear a bicycle helmet.

- (2) In this section—

bicycle trailer means a vehicle that is built to be towed, or is towed, by a bicycle.

258 Equipment on a bicycle

A person must not ride a bicycle that does not have—

- (a) at least 1 effective brake; and
- (b) a bell, horn or similar warning device in working order.

Maximum penalty—20 penalty units.

259 Riding at night

The rider of a bicycle must not ride at night, or in hazardous weather conditions causing reduced visibility, unless the bicycle or rider displays—

- (a) a flashing or steady white light that is clearly visible for at least 200m from the front of the bicycle; and
- (b) a flashing or steady red light that is clearly visible for at least 200m from the rear of the bicycle; and
- (c) a red reflector that is clearly visible for at least 50m from the rear of the bicycle when light is projected onto it by a vehicle's headlight on low-beam.

Maximum penalty—20 penalty units.

260 Stopping for a red bicycle crossing light

- (1) The rider of a bicycle approaching or at an intersection, or another place on a road or road-related area, with bicycle crossing lights must comply with this section.

Maximum penalty—20 penalty units.

- (2) If the bicycle crossing lights show a red bicycle crossing light and the rider has not already started crossing the intersection or place, the rider must not start to cross until—
 - (a) the bicycle crossing lights change to green; or
 - (b) there is no red or yellow bicycle crossing light showing.

[s 261]

Example—



Red bicycle crossing light



Green bicycle crossing light

- (3) In this section—
road includes any shoulder of the road.

261 Stopping for a yellow bicycle crossing light

- (1) The rider of a bicycle approaching or at an intersection, or another place on a road or road-related area, with bicycle crossing lights must comply with this section.
Maximum penalty—20 penalty units.
- (2) If the bicycle crossing lights show a yellow bicycle crossing light and the rider has not already started crossing the intersection or place, the rider must not start to cross until—
- (a) the bicycle crossing lights change to green; or
 - (b) there is no red or yellow bicycle crossing light showing.

Example—



Yellow bicycle crossing light

- (3) In this section—
road includes any shoulder of the road.

262 Proceeding when bicycle crossing lights change to yellow or red

- (1) The rider of a bicycle who is crossing at an intersection, or another place on a road, with bicycle crossing lights and traffic lights must comply with this section.

Maximum penalty—20 penalty units.

- (2) If the bicycle crossing lights change from green to yellow, flashing yellow, red or flashing red while the rider is crossing the road, the rider must not stay on the road for longer than necessary to cross safely to the nearer (in the direction of travel of the rider) of the following—
- (a) a dividing strip, safety zone, or traffic island, forming part of the area set aside or used by riders of bicycles to cross the road at the intersection or place (a *safety area*);
 - (b) the far side of the road.
- (2A) Despite subsection (2), the rider may instead return to the side of the road, or a safety area, that the rider has just left, but only if—
- (a) at the time the lights change, that side or safety area is closer to the rider than the side or safety area the rider was approaching at the time; and
 - (b) the rider does not stay on the road for longer than is necessary to return to that side or safety area.
- (3) If, under subsection (2) or (2A), the rider crosses, or returns, to a safety area, the rider must remain in the safety area until the bicycle crossing lights change to green.
- (4) However, if the rider can not operate the bicycle crossing lights from the safety area, the rider may cross to the far side of the road when—
- (a) the traffic lights change to green or flashing yellow, or there is no red traffic light showing; and
 - (b) it is safe to do so.
- (5) In this section—

[s 263]

road does not include a road-related area, but includes any shoulder of the road.

Part 16 **Rules for persons travelling in or on vehicles**

263 **Application of part to persons in or on trams**

This part, except section 269(1), does not apply to a person in or on a tram.

264 **Wearing of seatbelts by drivers**

- (1) The driver of a motor vehicle that is moving, or is stationary but not parked, must comply with this section if the driver's seating position is fitted with an approved seatbelt.

Maximum penalty—20 penalty units.

- (2) The driver must wear the seatbelt properly adjusted and fastened unless the driver is—
 - (a) reversing the vehicle; or
 - (b) exempt from wearing a seatbelt under section 267.

265 **Wearing of seatbelts by passengers 16 years old or older**

- (1) A passenger in or on a motor vehicle that is moving, or that is stationary but not parked, must comply with subsection (2) if the passenger—

- (a) is 16 years old or older; and
- (b) is not exempt from wearing a seatbelt under section 267.

Maximum penalty—20 penalty units.

- (2) The passenger—

-
- (a) must occupy a seating position that is fitted with an approved seatbelt; and
 - (b) must not occupy the same seating position as another passenger (whether or not the other passenger is exempt from wearing a seatbelt under section 267); and
 - (c) must wear the seatbelt properly adjusted and fastened.
- (3) The driver of a motor vehicle (except a bus or taxi) that is moving, or that is stationary but not parked, must ensure that each passenger in or on the vehicle who is 16 years old or older complies with subsection (2), unless the passenger is exempt from wearing a seatbelt under section 267.

Maximum penalty—20 penalty units.

- (4) Subsection (2)(b) does not apply to a passenger in a bus, taxi or tow truck who has a child who is less than 1 year old seated in the passenger's lap if—
- (a) no suitable approved child restraint is fitted and available for use; and
 - (b) the bus, taxi or tow truck has 2 or more rows of seats—the passenger is not in the front row of seats.
- (5) A relevant detention officer who is the driver of a detention vehicle in relation to a passenger who is a detained person need not comply with subsection (3)—
- (a) if—
 - (i) the vehicle has 2 or more rows of seats; and
 - (ii) the passenger is not in the front row of seats unless there is no seating position in which the passenger can sit because all other seating positions are occupied by other passengers; or
 - (b) if—
 - (i) the vehicle has a caged or other secured area designed for the carriage of passengers; and
 - (ii) the passenger occupies a seating position in the caged or secured area.

[s 266]

266 Wearing of seatbelts by passengers under 16 years old

- (1) The driver of a motor vehicle (except a bus or motorbike) that is moving, or is stationary but not parked, must ensure that this section is complied with for each passenger in or on the vehicle who is under 16 years old.

Maximum penalty—20 penalty units.

- (2) If the passenger is less than 6 months old, the passenger must be restrained in a suitable and properly fastened and adjusted rearward facing approved child restraint.
- (2A) If the passenger is 6 months old or older, but is less than 4 years old, the passenger must be restrained in a suitable and properly fastened and adjusted—
- (a) rearward facing approved child restraint; or
 - (b) forward facing approved child restraint that has an inbuilt harness.
- (2B) If the passenger is 4 years old or older, but is less than 7 years old, the passenger must—
- (a) be restrained in a suitable and properly fastened and adjusted forward facing approved child restraint that has an inbuilt harness; or
 - (b) be placed on a properly positioned approved booster seat and be restrained by—
 - (i) a lap and sash type approved seatbelt that is properly adjusted and fastened; or
 - (ii) a suitable approved child safety harness that is properly adjusted and fastened; or
 - (c) if the passenger is seated in a seating position in a part of the vehicle that is designed primarily for the carriage of goods—
 - (i) be restrained by an approved seatbelt of a lap and sash type that is properly adjusted and fastened; or
 - (ii) have the midsection of his or her body restrained by an approved seatbelt of a lap type that is

properly adjusted and fastened, and have his or her upper body restrained by an approved child safety harness that is properly adjusted and fastened.

- (3) A passenger who is under 4 years old must not be in the front row of a motor vehicle that has 2 or more rows of seats.
- (3A) A passenger who is 4 years old or older, but is less than 7 years old, must not be in the front row of a motor vehicle that has 2 or more rows of seats unless in the row or rows behind the front row—
 - (a) all of the other seats are occupied by passengers who are also less than 7 years old; or
 - (b) there is no remaining seating position in which the passenger can sit in accordance with this section because of the occupation of other seats, in compliance with this section, by passengers who are also less than 7 years old.

Example—

This subsection would permit a passenger who is 6 years old to sit in the front row of a vehicle that has 2 rows of seats if 2 occupied approved child restraints in the back row encroached on an empty seating position between them in a way that made it impossible for another approved child restraint or booster seat to be placed in that position.

- (4) If the passenger is 7 years old or older but under 16 years old—
 - (a) the passenger must be restrained in a suitable approved child restraint that is properly adjusted and fastened; or
 - (b) the passenger—
 - (i) must occupy a seating position that is fitted with a suitable approved seatbelt; and
 - (ii) must not occupy the same seating position as another passenger (whether or not the other passenger is exempt from wearing a seatbelt under section 267); and
 - (iii) must wear the seatbelt properly adjusted and fastened.

[s 266]

- (4A) Subsections (2), (2A), (2B) and (4) do not apply if the passenger is exempt from wearing a seatbelt under section 267.
- (4B) If a passenger can not safely be restrained as required by subsection (2) because of the passenger's height or weight, the passenger must be restrained as if subsection (2A) applied to the passenger.
- (4C) If a passenger can not safely be restrained as required by subsection (2A) or (4B) because of the passenger's height or weight, the passenger must be restrained as if subsection (2B) applied to the passenger.
- (4D) If a passenger can not safely be restrained as required by subsection (2B) or (4C) because of the passenger's height or weight, the passenger must be restrained as if subsection (4) applied to the passenger.
- (4E) In the case of a passenger sitting in a seating position that is fitted with a lap and sash type seatbelt, it is sufficient compliance with subsection (2B)(b) or (4)(b)(iii), as the case may be, if, instead of using the sash part of the seatbelt, an approved child safety harness that is properly adjusted and fastened is used to restrain the upper body of the passenger.
- (5) The driver of a taxi is exempt from subsections (2), (2A) and (2B) in relation to a passenger if—
 - (a) there is no suitable approved child restraint available in the taxi for the passenger; and
 - (b) if the taxi has 2 or more rows of seats—the passenger is not in the front row of seats.
- (5A) Subsection (1) does not apply to a relevant detention officer who is the driver of a detention vehicle—
 - (a) if—
 - (i) the vehicle has 2 or more rows of seats; and
 - (ii) the passenger is not in the front row of seats unless there is no seating position in which the passenger can sit because all other seating positions are occupied by other passengers; or

-
- (b) if—
 - (i) the vehicle has a caged or other secured area designed for the carriage of passengers; and
 - (ii) the passenger occupies a seating position in the caged or secured area.
 - (6) For this section—
 - (a) an approved child restraint is available in the motor vehicle for a passenger if an approved child restraint is fitted in the vehicle and is not occupied by someone else under 16 years old; and
 - (b) an approved child restraint or approved seatbelt is suitable for a passenger if it is suitable for restraining, or to be worn by the passenger.
 - (6A) For this section, a child restraint that is properly fastened and adjusted—
 - (a) is forward facing if, once it restrains a passenger, the passenger's head is closer to the rear of the vehicle than the passenger's feet; or
 - (b) is rearward facing if, once it restrains a passenger, the passenger's feet are closer to the rear of the vehicle than the passenger's head.
 - (7) In this section—

approved booster seat means—

 - (a) a booster seat or cushion that complies with—
 - (i) AS/NZS 1754; or
 - (ii) another standard the chief executive considers is at least equal to that standard; or
 - (b) a child restraint that—
 - (i) is incorporated in a vehicle; and
 - (ii) is of a type mentioned in—
 - (A) the *Vehicle Standard (Australian Design Rule 34/01—Child Restraint Anchorages and*

[s 267]

Child Restraint Anchor Fittings) 2005 (Cwlth), clause 34.8; or

(B) the *Vehicle Standard (Australian Design Rule 34/02—Child Restraint Anchorages and Child Restraint Anchor Fittings)* 2012 (Cwlth), clause 34.9; and

(iii) complies with that clause.

approved child restraint means a child restraint that complies with—

- (a) AS/NZS 1754; or
- (b) another standard the chief executive considers is at least equal to that standard.

approved child safety harness means a harness that complies with—

- (a) AS/NZS 1754; or
- (b) another standard the chief executive considers is at least equal to that standard.

267 Exemptions from wearing seatbelts

- (1A) A person in or on a motor vehicle is exempt from wearing a seatbelt if—
 - (a) the seating position that the person occupies is not fitted with a seatbelt; and
 - (b) there is no requirement for that seating position to be fitted with a seatbelt; and
 - (c) all passengers in the vehicle who are exempt from wearing a seatbelt are complying with subsection (8).
- (1B) Subsection (1A) does not apply to a person who is under 7 years old.
- (1C) To remove any doubt, it is declared that subsection (1A) does not authorise a passenger to whom section 266(3) or (3A) applies to occupy a seat in the front row of seats in a vehicle that has 2 or more rows of seats.

-
- (2) A person in or on a motor vehicle who is 7 years of age or older is exempt from wearing a seatbelt if—
- (a) the person is engaged in the door-to-door delivery or collection of goods, or in the collection of waste or garbage, and is required to get in or out of the vehicle, or on or off the vehicle, at frequent intervals; and
 - (b) the vehicle is not travelling over 25km/h.
- (3A) A person is exempt from wearing a seatbelt if—
- (a) the person (or, for a passenger, the driver of the vehicle in or on which the person is a passenger) is carrying a certificate that—
 - (i) is signed by a doctor; and
 - (ii) states that, in the opinion of the doctor, the person should not wear a seatbelt due to the person's medical condition; and
 - (iii) displays a date of issue; and
 - (iv) displays an expiry date that is a date not more than 12 months after the date of issue; and
 - (v) has not expired; and
 - (b) the person is complying with any conditions stated in the certificate.
- (4) However, a person is not exempt under subsection (3A) if the person (or, for a passenger, the driver of the vehicle in or on which the person is a passenger) does not immediately produce the certificate mentioned in the subsection for inspection when a police officer asks the person (or the driver) whether the person is exempt from wearing a seatbelt.
- (5) A person is exempt from wearing a seatbelt if—
- (a) the person is a passenger in or on a police or emergency vehicle; and
 - (b) either—
 - (i) if the vehicle has 2 or more rows of seats—the person is not in the front row of seats or there is not

[s 267]

- a seating position available for the person in another row of seats; or
- (ii) if the vehicle is a police vehicle and has a caged, or other secured, area designed for the carriage of passengers—the person occupies a seating position in that area.
- (6) A person is exempt from wearing a seatbelt if the person is providing or receiving medical treatment of an urgent and necessary nature while in or on a vehicle.
- (7) If a truck or bus has a sleeper compartment, a two-up driver of the truck or bus is exempt from wearing a seatbelt while the two-up driver occupies the sleeper compartment for rest purposes.
- (8) If a vehicle does not have approved seatbelts or approved child restraints fitted to all its passenger seating positions, a passenger who is exempt from wearing a seatbelt under this section must not occupy—
- (a) a seating position that is fitted with an approved seatbelt; or
- (b) an approved child restraint;
- if the result would be that a passenger who is not exempt from wearing a seatbelt under this section would be required to occupy a seating position that is not fitted with an approved seatbelt or an approved child restraint.
- (8A) A person is exempt from wearing a seatbelt while the person is driving a taxi with 1 or more passengers in it.
- (8B) A passenger on a bus is exempt from wearing a seatbelt while the passenger is—
- (a) a standing passenger mentioned in the *Transport Operations (Passenger Transport) Standard 2010*, section 11(2)(c) and (d); or
- (b) entering or leaving the bus.
- (8C) A passenger on a bus, taxi or tow truck is exempt from wearing a seatbelt if—

-
- (a) the passenger is less than 1 year old; and
 - (b) no suitable approved child restraint is fitted and available for use by the passenger; and
 - (c) if the bus, taxi or tow truck has 2 or more rows of seats—the passenger is not in the front row of seats; and
 - (d) the passenger is seated in the lap of another passenger who is 16 years of age or older; and
 - (e) if the vehicle is a tow truck—the person is a passenger in the tow truck because the vehicle in which the person was a passenger is being towed.
- (8D) To remove any doubt, it is declared that subsection (8C) does not limit the exemption given to—
- (a) a bus driver in relation to a passenger under section 266(1); or
 - (b) a taxi driver in relation to a passenger under section 266(5).
- (9) In this section—
- two-up driver*, for a vehicle that is a bus or truck, means a person accompanying the vehicle's driver on a journey or part of a journey, who has been, is or will be, sharing the task of driving the vehicle during the journey.

268 How persons must travel in or on a motor vehicle

- (1) A person must not travel in or on a part of a motor vehicle that is not a part designed primarily for the carriage of passengers or goods.
Maximum penalty—20 penalty units.
- (2) A person must not travel in or on a part of a motor vehicle that is a part designed primarily for the carriage of goods unless—
 - (a) the part is enclosed; and
 - (b) the person occupies a seating position that is suitable for the size and weight of the person and is fitted with an approved seatbelt.

[s 268]

Maximum penalty—20 penalty units.

- (3) A person must not travel in or on a motor vehicle with any part of the person's body outside a window or door of the vehicle, unless the person is the driver of the vehicle and is giving a hand signal—
- (a) for changing direction to the right in accordance with section 50; or
 - (b) for stopping or slowing in accordance with section 55.

Maximum penalty—20 penalty units.

- (4) The driver of a motor vehicle (except a bus) must not drive with a passenger if any part of the passenger's body is outside a window or door of the vehicle.

Maximum penalty—20 penalty units.

- (4A) The driver of a motor vehicle must not drive with a passenger in or on a part of the vehicle that is not a part designed primarily for the carriage of passengers or goods.

Maximum penalty—20 penalty units.

- (4B) The driver of a motor vehicle must not drive with a passenger in or on a part of the vehicle that is a part designed primarily for the carriage of goods unless—
- (a) the part is enclosed; and
 - (b) the person occupies a seating position that is suitable for the size and weight of the person and is fitted with an approved seatbelt.

Maximum penalty—20 penalty units.

- (5) This section does not apply to a person who is—
- (a) in or on a police or emergency vehicle; or
 - (b) on a motorbike; or
 - (c) engaged in the door-to-door delivery or collection of goods, or in the collection of waste or garbage, in or on a motor vehicle that is not travelling over 25km/h.

- (6) In this section—

enclosed, for a part of a vehicle—

- (a) means enclosed by the structure of the vehicle; but
- (b) does not include enclosed by a canopy or cage fitted to the vehicle.

269 Opening doors and getting out of a vehicle etc.

- (1) A person must not get off, or out of, a moving vehicle, unless the person is engaged in the door-to-door delivery or collection of goods, or in the collection of waste or garbage, and the vehicle is not travelling over 5km/h.

Maximum penalty—20 penalty units.

- (2) Subsection (1) does not apply to a person getting off a bicycle or animal.
- (3) A person must not cause a hazard to any person or vehicle by opening a door of a vehicle, leaving a door of a vehicle open, or getting off, or out of, a vehicle.

Maximum penalty—20 penalty units.

- (4) The driver of a bus must not drive the bus unless the doors of the bus are closed while the bus is moving.

Maximum penalty—20 penalty units.

270 Wearing motorbike helmets

- (1) The rider of a motorbike that is moving, or is stationary but not parked, must—

- (a) wear an approved motorbike helmet securely fitted and fastened on the rider's head; and
- (b) not ride with a passenger unless the passenger complies with subsection (2).

Maximum penalty—20 penalty units.

- (2) A passenger on a motorbike that is moving, or is stationary but not parked, must wear an approved motorbike helmet securely fitted and fastened on the passenger's head.

[s 271]

Maximum penalty—20 penalty units.

(3) In this section—

approved motorbike helmet means a helmet that complies with—

- (a) AS 1698; or
- (b) AS/NZS 1698; or
- (c) another standard the chief executive considers is at least equal to a standard mentioned in paragraph (a) or (b).

passenger, of a motorbike, includes a person on a passenger seat of the motorbike, including the pillion seat, or in a sidecar.

271 Riding on motorbikes

- (1) The rider of a motorbike that is moving (other than a rider who is walking beside and pushing a motorbike), or the rider of a motorbike that is stationary but not parked, must—
- (a) sit astride the rider's seat facing forwards; and
 - (b) ride with at least 1 hand on the handlebars; and
 - (c) if the motorbike is moving—keep both feet on the footrests designed for use by the rider of the motorbike.

Maximum penalty—20 penalty units.

- (2) A passenger on a motorbike (except a passenger in a sidecar or on a seat, other than a pillion seat, designed for a passenger) that is moving, or is stationary but not parked, must—
- (a) sit astride the pillion seat facing forwards; and
 - (b) keep both feet on the footrests designed for use by a pillion passenger on the motorbike.

Maximum penalty—20 penalty units.

- (3) The rider of a motorbike must not ride with a passenger (except a passenger in a sidecar or on a seat, other than a

pillion seat, designed for a passenger) unless the passenger complies with subsection (2).

Maximum penalty—20 penalty units.

- (4) The rider of a motorbike must not ride with more than 1 passenger (excluding any passenger in a sidecar or on a seat, other than a pillion seat, designed for a passenger).

Maximum penalty—20 penalty units.

- (5) The rider of a motorbike must not ride with more passengers in a sidecar, or on a seat designed for a passenger, than the sidecar or seat is designed to carry.

Maximum penalty—20 penalty units.

- (5A) The rider of a motorbike must not ride with a passenger (except a passenger in a sidecar) unless the passenger is at least 8 years old.

Maximum penalty—20 penalty units.

- (5B) A passenger must not ride in a sidecar of a motorbike unless the passenger is seated safely.

Maximum penalty—20 penalty units.

- (5C) The rider of a motorbike must not ride with a passenger in a sidecar unless the passenger complies with subsection (5B).

Maximum penalty—20 penalty units.

272 Interfering with the driver's control of the vehicle etc.

A passenger in or on a vehicle must not—

- (a) interfere with the driver's control of the vehicle; or
- (b) obstruct the driver's view of the road or traffic.

Maximum penalty—20 penalty units.

[s 273]

Part 17 Additional rules for drivers of trams, tram recovery vehicles and buses

Division 1 Trams

273 Division also applies to tram recovery vehicles and buses travelling along tram tracks

- (1) This division applies to the driver of a tram recovery vehicle as if a reference in the division to a tram included a reference to a tram recovery vehicle.
- (2) This division applies to the driver of a bus travelling along tram tracks as if a reference in the division to a tram included a reference to a bus travelling along tram tracks.

274 Stopping for a red T light

The driver of a tram approaching or at T lights showing a red T light must stop—

- (a) if there is a stop line at or near the T lights—as near as practicable to, but before reaching, the stop line; or
- (b) if there is no stop line at or near the T lights—as near as practicable to, but before reaching, the nearest or only T lights.

Maximum penalty—20 penalty units.

275 Stopping for a yellow T light

The driver of a tram approaching or at T lights showing a yellow T light must stop—

- (a) if there is a stop line at or near the T lights and the driver can stop safely before reaching the stop line—as near as practicable to, but before reaching, the stop line; or

- (b) if there is no stop line at or near the T lights and the driver can stop safely before reaching the T lights—as near as practicable to, but before reaching, the nearest or only T lights.

Maximum penalty—20 penalty units.

276 Exception to stopping for a red or yellow T light

The driver of a tram approaching or at T lights showing a red or yellow T light does not have to stop if a white traffic arrow is also showing and the driver is turning in the direction indicated by the arrow.

277 Proceeding after stopping for a red or yellow T light

The driver of a tram who stops for T lights showing a red or yellow T light must not proceed until—

- (a) a white T light is showing; or
- (b) no T light is showing and traffic lights at or near the T lights are showing a green traffic light.

Maximum penalty—20 penalty units.

278 Proceeding when a red traffic light and a white T light or white traffic arrow is showing

- (1) The driver of a tram approaching or at a white T light at or near traffic lights showing a red traffic light may proceed straight ahead, or turn, despite the red traffic light.
- (2) The driver of a tram approaching or at a white traffic arrow at or near traffic lights showing a red traffic light may turn in the direction indicated by the arrow, despite the red traffic light.

[s 279]

Example—

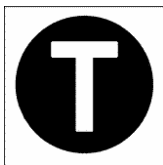

White T light

279 Proceeding when a white T light or white traffic arrow is no longer showing

- (1) This section applies to—
- (a) the driver of a tram at an intersection with T lights showing a white T light who has stopped after the stop line, or nearest or only T lights, at the intersection; or
 - (b) the driver of a tram at an intersection with traffic arrows showing a white traffic arrow who is turning in the direction indicated by the arrow and has stopped after the stop line, or nearest or only traffic arrows, at the intersection.

Example—

The driver of a tram may stop after the stop line at an intersection with T lights showing a white T light, and not proceed through the intersection, because the intersection, or a road beyond the intersection, is blocked by traffic.

- (2) If the T lights or traffic arrows change to yellow or red, or turn off, while the driver is stopped and the driver has not entered the intersection, the driver must not proceed until—
- (a) a white T light is showing; or
 - (b) there is no T light showing, and traffic lights at or near the T lights are showing a green traffic light; or
 - (c) if the driver is turning at the intersection—a white traffic arrow is showing that indicates the direction in which the driver is turning.

Maximum penalty—20 penalty units.

- (3) If the T lights or traffic arrows change to yellow or red, or turn off, while the driver is stopped and the driver has entered the intersection, the driver must leave the intersection as soon as the driver can do so safely.

Maximum penalty—20 penalty units.

Division 2 Buses, taxis and bicycles

280 Application of division

- (1) This division applies to any of the following who is driving in a bus lane—
 - (a) the driver of a bus;
 - (b) the driver of a taxi;
 - (c) the rider of a bicycle.
- (2) This division applies to the driver of a vehicle other than a bus, taxi or bicycle in the same way as it applies to the driver of a bus, if—
 - (a) the driver is driving in a bus lane to which B lights apply; and
 - (b) the driver is permitted to drive in the lane under this regulation.

281 Stopping for a red B light

The driver of a bus or taxi, or the rider of a bicycle, approaching or at B lights showing a red B light must stop—

- (a) if there is a stop line at or near the B lights—as near as practicable to, but before reaching, the stop line; or
- (b) if there is no stop line at or near the B lights—as near as practicable to, but before reaching, the nearest or only B lights.

[s 282]

Maximum penalty—20 penalty units.

282 Stopping for a yellow B light

The driver of a bus or taxi, or the rider of a bicycle, approaching or at B lights showing a yellow B light must stop—

- (a) if there is a stop line at or near the B lights and the driver or rider can stop safely before reaching the stop line—as near as practicable to, but before reaching, the stop line; or
- (b) if there is no stop line at or near the B lights and the driver or rider can stop safely before reaching the B lights—as near as practicable to, but before reaching, the nearest or only B lights.

Maximum penalty—20 penalty units.

283 Exception to stopping for a red or yellow B light

The driver of a bus or taxi, or the rider of a bicycle, approaching or at B lights showing a red or yellow B light does not have to stop if a white traffic arrow is also showing and the driver or rider is turning in the direction indicated by the arrow.

284 Proceeding after stopping for a red or yellow B light

The driver of a bus or taxi, or the rider of a bicycle, who stops for B lights showing a red or yellow B light must not proceed until—

- (a) a white B light is showing; or
- (b) no B light is showing and traffic lights at or near the B lights are showing a green traffic light.

Maximum penalty—20 penalty units.

285 Proceeding when a red traffic light and a white B light or white traffic arrow is showing

- (1) The driver of a bus or taxi, or the rider of a bicycle, approaching or at a white B light at or near traffic lights showing a red traffic light may proceed straight ahead, or turn, despite the red traffic light.
- (2) The driver of a bus or taxi, or the rider of a bicycle, approaching or at a white traffic arrow at or near traffic lights showing a red traffic light may turn in the direction indicated by the arrow, despite the red traffic light.

Example—

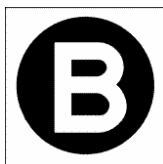

White B light

286 Proceeding when a white B light or white traffic arrow is no longer showing

- (1) This section applies to—
 - (a) the driver of a bus or taxi, or the rider of a bicycle, at an intersection with B lights showing a white B light who has stopped after the stop line, or nearest or only B lights, at the intersection; or
 - (b) the driver of a bus or taxi, or the rider of a bicycle, at an intersection with traffic arrows showing a white traffic arrow who is turning in the direction indicated by the arrow and has stopped after the stop line, or nearest or only traffic arrows, at the intersection.

Example—

The driver of a bus or taxi, or the rider of a bicycle, may stop after the stop line at an intersection with B lights showing a white B light, and

[s 287]

not proceed through the intersection, because the intersection, or a road beyond the intersection, is blocked by traffic.

- (2) If the B lights or traffic arrows change to yellow or red, or turn off, while the driver or rider is stopped and has not entered the intersection, the driver or rider must not proceed until—
- (a) a white B light is showing; or
 - (b) there is no B light showing, and traffic lights at or near the B lights are showing a green traffic light; or
 - (c) if the driver or rider is turning at the intersection—a white traffic arrow is showing that indicates the direction in which the driver or rider is turning.

Maximum penalty—20 penalty units.

- (3) If the B lights or traffic arrows change to yellow or red, or turn off, while the driver or rider is stopped and has entered the intersection, the driver or rider must leave the intersection as soon as the driver or rider can do so safely.

Maximum penalty—20 penalty units.

Part 18 **Miscellaneous road rules**

Division 1 **Miscellaneous rules for drivers**

287 **Duties of a driver involved in a crash**

- (1) This section applies to a driver involved in a crash.
- (2) The driver must stop at the scene of the crash and give the driver's required particulars, within the required time and, if practicable, at the scene of the crash, to—
 - (a) any other driver (or that driver's representative) involved in the crash; and

-
- (b) any other person involved in the crash who is injured, or the person's representative; and
 - (c) the owner of any property (including any vehicle) damaged in the crash (or the owner's representative), unless, in the case of damage to a vehicle, the particulars are given to the driver of the vehicle (or the driver's representative).

Maximum penalty—20 penalty units.

- (3) The driver must also give the driver's required particulars, within the required time, to the Queensland Police Service if—
 - (a) anyone is killed or injured in the crash; or
 - (b) the driver does not, for any reason, give the driver's required particulars to each person mentioned in subsection (2); or
 - (c) the required particulars for any other driver involved in the crash are not given to the driver; or
 - (d) a motor vehicle involved in the crash is towed or carried away by another vehicle.

Maximum penalty—20 penalty units.

- (4) In this section—
 - required particulars***, for a driver involved in a crash, means—
 - (a) the driver's name and address; and
 - (b) the name and address of the owner of the driver's vehicle; and
 - (c) the vehicle's registration number, if any; and
 - (d) any other information necessary to identify the vehicle.

required time, for a driver involved in a crash, means as soon as possible but, except in exceptional circumstances, within 24 hours after the crash.

[s 288]

288 Driving on a path

- (1) A driver (except the rider of a bicycle) must not drive on a path, unless subsection (2) or (3) applies to the driver.

Maximum penalty—20 penalty units.

- (2) A driver may drive on a path if the driver is—
- (a) driving on a part of the path indicated by information on or with a traffic control device as a part where vehicles may drive; or
 - (b) driving on the path to enter or leave, by the shortest practicable route, a road-related area or adjacent land and there is not a part of the path indicated by information on or with a traffic control device as a part where vehicles may drive.
- (3) A driver may drive a motorised wheelchair on a path if—
- (a) the unladen mass of the wheelchair is not over 150kg; and
 - (b) the wheelchair is not travelling over 10km/h; and
 - (c) because of the driver's physical condition, the driver has a reasonable need to use a wheelchair.
- (4) A driver on a path (except the rider of a bicycle, or a driver driving on the path to enter a road from a road-related area or adjacent land, or to enter a road-related area or adjacent land from a road) must give way to all other road users, and to animals, on the path.

Maximum penalty—20 penalty units.

- (5) This section does not apply to the rider of an animal riding the animal on a footpath.
- (6) In this section—

path means a bicycle path, footpath or shared path.

289 Driving on a nature strip

- (1) A driver must not drive on a nature strip adjacent to a length of road in a built-up area, unless the driver is—
- (a) entering or leaving, by the shortest practicable route, an area on the nature strip indicated by information on or with a traffic control device as an area where vehicles may drive; or
 - (b) driving on a part of the nature strip indicated by information on or with a traffic control device as a part where vehicles may drive; or
 - (c) driving on the nature strip to enter or leave, by the shortest practicable route, a road-related area or adjacent land and there is not a part of the nature strip indicated by information on or with a traffic control device as a part where vehicles may drive; or
 - (d) riding a bicycle or animal; or
 - (e) driving a ride-on lawnmower that is cutting grass on the nature strip; or
 - (f) driving a motorised wheelchair.

Maximum penalty—20 penalty units.

- (2) A driver driving on a nature strip (except the rider of an animal, or a driver driving on the nature strip to enter a road from a road-related area or adjacent land, or to enter a road-related area or adjacent land from a road) must give way to all other road users, and to animals, on the nature strip.

Maximum penalty—20 penalty units.

290 Driving on a traffic island

A driver must not drive on a traffic island (except the central traffic island in a roundabout), unless the traffic island is designed to allow vehicles to be driven on it.

Maximum penalty—20 penalty units.

[s 291]

291 Making unnecessary noise or smoke

- (1) A person must not—
- (a) start a vehicle, or drive a vehicle, in a way that makes unnecessary noise or smoke; or
 - (b) wilfully start a vehicle, or drive a vehicle, in a way that makes unnecessary noise or smoke.

Maximum penalty—20 penalty units.

Example for paragraph (a)—

driving a vehicle in a way that causes noise or smoke because of—

- (a) disrepair of the vehicle; or
- (b) the way the vehicle is loaded; or
- (c) the condition, construction or adjustment of the vehicle's engine or other equipment

Example for paragraph (b)—

driving a vehicle in a way that causes noise or smoke by wilfully and unnecessarily causing the wheels of the vehicle to lose traction and spin on the road surface

Note—

An offence against paragraph (b) is an offence mentioned in the *Police Powers and Responsibilities Act 2000*, section 69A(1)(a)(iv).

- (2) A person must not drive a vehicle to which a noisy instrument is attached or on which a noisy instrument is used.

Maximum penalty—20 penalty units.

- (3) The driver of a vehicle or a passenger in or on the vehicle must not—

- (a) ring a bell or sound a horn, except a horn or similar warning device under section 224; or
- (b) play or use a noisy instrument.

Maximum penalty—20 penalty units.

292 Section number not used

293 Removing fallen etc. things from the road

- (1) This section applies to a driver if—
- (a) something falls onto the road from the driver's vehicle, or the driver, or a passenger in or on the driver's vehicle, puts something on the road; and
 - (b) there is a possibility that the thing, if left on the road, may injure a person, obstruct the path of other drivers or pedestrians, or damage a vehicle or anything else (for example, the road surface).
- (2) The driver must remove the thing, or take action to have the thing removed, from the road as soon as the driver can do so safely.

Maximum penalty—20 penalty units.

Examples of things—

a fallen load, oil, grease, a wheel chock, debris from an accident

- (3) If something has fallen onto the road from a vehicle because of a crash and the vehicle is towed away by a person, the person must remove the thing from the road as soon as the person can do so safely.

Maximum penalty—20 penalty units.

- (4) In this section—
- put*, something onto the road, includes—
- (a) throw, drop or propel the thing onto the road; and
 - (b) otherwise cause the thing to be on the road.

293A Oil and grease

A person must not drive a vehicle without taking adequate precautions to stop oil or grease from the engine or another part of the vehicle dropping onto the road.

Maximum penalty—20 penalty units.

[s 293B]

293B Restriction on driving or stopping vehicle on road

- (1) A person must not drive or stop a vehicle on a road for the purpose of soliciting employment or business from the vehicle, unless the person—
 - (a) is permitted to drive or stop the vehicle for the primary purpose of business advertising under a permit issued under the *Traffic Regulation 1962*, section 126(1)(b); or
 - (b) is engaged in roadside vending under a permit or other authority given to the person under a local law.

Maximum penalty—20 penalty units.

- (2) In this section—

road includes a shoulder of a road, a median strip, a painted island or a traffic island, but does not include another road-related area.

294 Keeping control of a vehicle being towed

- (1) The driver of a motor vehicle must not tow another motor vehicle unless—
 - (a) either—
 - (i) the driver can control the movement of the towed vehicle; or
 - (ii) the brakes and steering of the towed vehicle are in working order and a person who is licensed to drive the towed vehicle is sitting in the driver's seat of the towed vehicle, and is in control of its brakes and steering; and
 - (b) it is safe to tow the towed vehicle.

Maximum penalty—20 penalty units.

- (2) The driver of a motor vehicle must not tow a trailer unless—
 - (a) the driver can control the movement of the trailer; and
 - (b) it is safe to tow the trailer.

Maximum penalty—20 penalty units.

- (3) The driver of a motor vehicle must not tow a bicycle, wheeled recreational device, wheeled toy or wheelchair.

Maximum penalty—20 penalty units.

- (4) The driver of a motor vehicle, other than a heavy vehicle, must not tow more than 1 motor vehicle or trailer.

Maximum penalty—20 penalty units.

- (5) However, the driver may tow a car towing trailer with a vehicle secured to the trailer if—

- (a) the trailer has effective independent brakes or overrun brakes; and
(b) instructions for securing a vehicle to the trailer are attached to the trailer.

- (6) In this section—

car towing trailer means a trailer with 1 axle that allows a vehicle to be towed by securing the wheels of 1 axle of the vehicle to the trailer.

motor vehicle does not include a trailer attached to the motor vehicle.

295 Motor vehicle towing another vehicle with a towline

- (1) The driver of a motor vehicle towing another vehicle using a chain, rope, fabric, strap or wire (the *towline*) must comply with this section.

Maximum penalty—20 penalty units.

- (2) If neither of the vehicles is a motorbike, the driver must keep a distance of not over 4m between the vehicles.
- (3) If at least 1 of the vehicles is a motorbike, the driver must keep a distance of not over 2.5m between the vehicles.
- (4) If the towline is longer than 2m, the driver must attach a white or brightly coloured flag, piece of cloth or other similar material (the *warning material*) to the towline in accordance with subsection (5).

[s 296]

- (5) The warning material must—
 - (a) be substantially square or rectangular with 2 adjacent sides at least 300mm long; and
 - (b) be attached midway along the towline; and
 - (c) be visible for at least 100m from either side of the warning material.
- (6) If the driver is towing at night, the driver must ensure the warning material is lit by a light attached to 1 of the vehicles.

296 Driving a vehicle in reverse

- (1) The driver of a vehicle must not reverse the vehicle unless the driver can do so safely.

Maximum penalty—20 penalty units.

- (2) The driver of a vehicle must not reverse the vehicle further than is reasonable in the circumstances.

Maximum penalty—20 penalty units.

297 Driver to have proper control of a vehicle etc.

- (1) A driver must not drive a vehicle unless the driver has proper control of the vehicle.

Maximum penalty—20 penalty units.

- (1A) A driver must not drive a vehicle if a person or an animal is in the driver's lap.

Maximum penalty—20 penalty units.

- (2) A driver must not drive a motor vehicle unless the driver has a clear view of the road, and traffic, ahead, behind and to each side of the driver.

Maximum penalty—20 penalty units.

- (3) The rider of a motorbike must not ride with an animal on the motorbike between the rider and the handle bars, or in another

position that interferes with the rider's ability to control the motorbike or to have a clear view of the road.

Maximum penalty—20 penalty units.

- (4) Subsection (3) does not apply to the rider of a motorbike who rides with an animal between the rider and the handle bars for a distance of not more than 500 metres on a road for the purpose of a farming activity that the rider is carrying out.

298 Driving with a person in a trailer

A driver must not drive a motor vehicle towing a trailer with a person in or on the trailer.

Maximum penalty—20 penalty units.

299 Television receivers and visual display units in motor vehicles

- (1) A driver must not drive a motor vehicle that has a television receiver or visual display unit in or on the vehicle operating while the vehicle is moving, or is stationary but not parked, if any part of the image on the screen—
- (a) is visible to the driver from the normal driving position;
or
 - (b) is likely to distract another driver.

Maximum penalty—20 penalty units.

- (2) This section does not apply to the driver if—
- (a) the driver is driving a bus and the visual display unit is, or displays, a destination sign or other bus sign; or
 - (b) the visual display unit—
 - (i) is, or is part of, a driver's aid; and
 - (ii) is not being held by the driver in the driver's hand;
or

Examples of driver's aids—

- closed-circuit television security cameras

[s 300]

- dispatch system
 - mobile phones or tablet computers equipped with GPS receivers, or paired with GPS receivers by bluetooth, being used as navigational aids
 - navigational or intelligent highway and vehicle system equipment
 - rearview screens
 - ticket-issuing machines
 - vehicle monitoring devices
- (ba) the visual display unit is a mobile data terminal fitted to a police vehicle or an emergency vehicle.

300 Use of mobile phones

- (1) The driver of a vehicle (except an emergency vehicle or police vehicle) must not use a mobile phone that the driver is holding in the driver's hand while the vehicle is moving, or is stationary but not parked.

Maximum penalty—20 penalty units.

- (2) In this section—

mobile phone does not include a CB radio or any other two-way radio.

use, in relation to a mobile phone, includes any of the following—

- (a) holding the phone to, or near, the ear, whether or not engaged in a phone call;
- (b) writing, sending or reading a text message on the phone;
- (c) turning the phone on or off;
- (d) operating any other function of the phone.

300A Drinking liquor while driving

- (1) The following persons must not drink liquor—

- (a) the driver of a vehicle while driving the vehicle;

- (b) a supervisor of a learner while the learner is driving a motor vehicle under the direction of the supervisor.

Maximum penalty—20 penalty units.

- (2) In this section—

learner see the Act, section 79AA(4).

supervisor, of a learner, means a person—

- (a) with whom a learner is authorised to drive under the person's direction under the *Transport Operations (Road Use Management—Driver Licensing) Regulation 2010*; or
- (b) who purports to be a person mentioned in paragraph (a).

300C Limitation on use of wheeled recreational device or wheeled toy

- (1) A person must not travel in or on a wheeled recreational device or wheeled toy if a propellant is attached to it or the person.

Maximum penalty—20 penalty units.

- (2) In this section—

propellant means a machine (other than a lever, wheel and axle, pulley, screw, wedge or inclined plane) capable of propelling a wheeled recreational device or wheeled toy.

300D Driver must not damage rail infrastructure or obstruct level crossing

- (1) A driver must not cause damage to rail infrastructure at a railway crossing, unless the driver has a reasonable excuse.

Maximum penalty—80 penalty units.

- (2) A driver driving near, on or through a level crossing must not cause an obstruction to the path of trains or other drivers through the level crossing, unless the driver has a reasonable excuse.

[s 301]

Maximum penalty—80 penalty units.

(3) In this section—

damage, to rail infrastructure, means damage that hinders or prevents the normal operation or use of the rail infrastructure.

railway crossing means a level crossing, bridge or another structure used to cross over or under a railway.

rail infrastructure means the following—

- (a) a warning bell, warning light, gate, boom or barrier;
- (b) rail transport infrastructure within the meaning of the *Transport Infrastructure Act 1994*.

Division 2 Rules for people in charge of animals

301 Leading an animal while in or on a vehicle

(1) The driver of a motor vehicle must not lead an animal, including by tethering the animal to the motor vehicle.

Maximum penalty—20 penalty units.

(2) A person who is a passenger in, or on any part of, a motor vehicle must not lead an animal while the motor vehicle is moving.

Maximum penalty—20 penalty units.

(3) The rider of a bicycle must not lead an animal, including by tethering the animal to the bicycle.

Maximum penalty—20 penalty units.

(4) The rider of an animal must not lead more than 1 other animal on a road, unless the rider holds a permit issued by a local government.

Maximum penalty—20 penalty units.

301A Harnessing an animal drawing a vehicle

The driver of a vehicle drawn by an animal must ensure the animal is harnessed in a way that enables the driver to—

- (a) control the animal; and
- (b) regulate its speed.

Maximum penalty—20 penalty units.

301B Riding an animal on a road-related area when possible

- (1) A person must not ride or lead an animal on a road if it is practicable to ride or lead the animal on a road-related area.

Maximum penalty—20 penalty units.

- (2) In this section—

road does not include a road-related area, but includes any shoulder of the road.

302 Rider of an animal on a footpath or nature strip to give way to pedestrians

The rider of an animal must give way to any pedestrian on a footpath or nature strip.

Maximum penalty—20 penalty units.

303 Riding an animal alongside more than 1 other rider

- (1) The rider of an animal must not ride on a road alongside more than 1 other rider, unless the rider is overtaking the other riders or droving stock.

Maximum penalty—20 penalty units.

- (2) If the rider of an animal is riding on a road alongside another rider, the rider must ride not over 1.5m from the other rider.

Maximum penalty—20 penalty units.

- (3) In this section—

[s 303A]

road does not include a road-related area, but includes a bicycle path, shared path and any shoulder of the road.

303A Giving way to restive horses

- (1) This section applies if a person in charge of a restive horse gives a signal, by raising a hand and pointing to the horse, to the driver of a motor vehicle on a road.
- (2) The driver must—
 - (a) drive the vehicle as near as practicable to the far left side of the road; and
 - (b) stop the vehicle's engine; and
 - (c) not move the vehicle until there is no reasonable likelihood that the noise of the motor, or the movement of the vehicle, will aggravate the restiveness of the horse.

Maximum penalty—20 penalty units.

- (3) In this section—

in charge of includes leading, driving or riding.

Division 2A Rules for people in charge of animal-drawn vehicles

303B Brakes

- (1) A person in charge of an animal drawing a vehicle must ensure that the vehicle has an efficient brake capable of stopping and holding the vehicle.

Maximum penalty—20 penalty units.

- (2) For a 2-wheeled vehicle, subsection (1) is satisfied if the vehicle is attached to the animal by a harness that is suitable and sufficient to enable the vehicle to be stopped.

-
- (3) If the vehicle is a van, lorry, wagon, or other heavy animal drawn vehicle, subsection (1) is not satisfied if the vehicle is equipped only with a nave brake.

Division 3 Obeying directions

304 Direction by police officer or traffic controller

- (1) It is a defence to the prosecution of a person for an offence against a provision of this regulation if, at the time of the offence, the person was obeying a direction given to the person—
- (a) by a police officer under the *Police Powers and Responsibilities Act 2000*, section 59; or
 - (b) by a traffic controller carrying out the functions of a traffic controller under the *Transport Operations (Road Use Management—Accreditation and Other Provisions) Regulation 2005*, section 26.
- (2) In this section—

traffic controller means a person who holds an appointment under the *Transport Operations (Road Use Management—Accreditation and Other Provisions) Regulation 2005*, part 2 as an accredited person with the function of a traffic controller.

Part 19 Exemptions

305 Exemption for drivers of police vehicles

- (1) A provision of this regulation does not apply to the driver of a police vehicle if—
- (a) in the circumstances—
 - (i) the driver is taking reasonable care; and

[s 306]

- (ii) it is reasonable that the provision should not apply;
and
 - (b) if the vehicle is a motor vehicle that is moving—the vehicle is displaying a blue or red flashing light or sounding an alarm.
- (2) Subsection (1)(b) does not apply to the driver if, in the circumstances, it is reasonable—
 - (a) not to display the light or sound the alarm; or
 - (b) for the vehicle not to be fitted or equipped with a blue or red flashing light or an alarm.

306 Exemptions for drivers of emergency vehicles

A provision of this regulation does not apply to the driver of an emergency vehicle if—

- (a) in the circumstances—
 - (i) the driver is taking reasonable care; and
 - (ii) it is reasonable that the provision should not apply;
and
- (b) if the vehicle is a motor vehicle that is moving—the vehicle is displaying a red flashing light or sounding an alarm.

307 Stopping and parking exemption for police and emergency vehicles

A provision of part 12 does not apply to the driver of a police vehicle or emergency vehicle if, in the circumstances—

- (a) the driver is taking reasonable care; and
- (b) it is reasonable that the provision should not apply.

308 Exemption for police officers and emergency workers on foot

A provision of part 14 does not apply to a police officer or emergency worker on foot and acting in the course of the police officer's or emergency worker's duty if, in the circumstances—

- (a) the police officer or emergency worker is taking reasonable care; and
- (b) it is reasonable that the provision should not apply.

308A Exemption for police officers using personal mobility devices

Sections 244E, 244G and 244O do not apply to a police officer using a personal mobility device and acting in the course of the police officer's duty if, in the circumstances—

- (a) the police officer is taking reasonable care; and
- (b) it is reasonable that the sections should not apply.

309 Exemptions for drivers of trams etc.

The following provisions do not apply to the driver of a tram, the driver of a tram recovery vehicle engaged in accessing or recovering a disabled tram, or the driver of a bus travelling along tram tracks—

- part 4 (Making turns), division 1 (Left turns)
- section 88 (Left turn signs)
- section 89 (Right turn signs)
- section 90 (No turns signs)
- section 91 (No left turn and no right turn signs)
- section 92 (Traffic lane arrows)
- section 99 (Keep left and keep right signs)
- section 100 (No entry signs)

[s 310]

- part 9 (Roundabouts)
- part 11 (Keeping left, overtaking and other driving rules), divisions 2 (Keeping to the left), 3 (Overtaking), and 7 (Passing trams and safety zones)
- part 12 (Restrictions on stopping and parking).

310 Exemption for road workers etc.

- (1) A provision mentioned in subsection (2) does not apply to a person at the site of, and engaged in, roadworks if, in the circumstances—
 - (a) it is not practicable for the person to comply with the provision; and
 - (b) sufficient warning of the roadworks has been given to other road users.
- (2) Subsection (1) applies to the following provisions—
 - part 4 (Making turns), divisions 1 (Left turns) and 2 (Right turns)
 - part 7 (Giving way), except—
 - section 67 (Stopping and giving way at a stop sign or stop line at an intersection without traffic lights)
 - section 68 (Stopping and giving way at a stop sign or stop line at other places)
 - section 69 (Giving way at a give way sign or give way line at an intersection, other than a roundabout)
 - section 70 (Giving way at a give way sign at a bridge or length of narrow road)
 - section 71 (Giving way at a give way sign or give way line at other places)
 - part 8 (Traffic signs and road markings), except—
 - section 102 (Clearance and low clearance signs)
 - section 103 (Load limit signs)

-
- part 11 (Keeping left, overtaking and other driving rules)
 - part 12 (Restrictions on stopping and parking)
 - section 224 (Using horns and similar warning devices)
 - part 14 (Rules for pedestrians), except section 236(1) (which is about causing a traffic hazard by moving into the path of an approaching vehicle)
 - section 264 (Wearing of seatbelts by drivers)
 - section 265 (Wearing of seatbelts by passengers 16 years old or older)
 - section 268 (How persons must travel in or on a motor vehicle)
 - section 288 (Driving on a path)
 - section 289 (Driving on a nature strip)
 - section 290 (Driving on a traffic island)
 - section 295 (Motor vehicle towing another vehicle with a towline)
 - section 296 (Driving a vehicle in reverse)
 - section 297(2) (which requires a driver to have a clear view of the surrounding road and traffic)
 - section 298 (Driving with a person in a trailer).
- (3) Section 20 does not apply to a driver driving a snow-clearing vehicle and engaged in snow clearing.
- (4) In this section—
- road transport infrastructure*** has the meaning given by the *Transport Infrastructure Act 1994*.
- roadworks*** means—
- (a) construction or maintenance of a road or road transport infrastructure; or
 - (b) road cleaning; or

[s 311]

- (c) installation or maintenance of a traffic control device, traffic-related item or traffic monitoring device; or
- (d) a road surface survey test.

311 Exemption for oversize vehicles

- (1) A provision mentioned in subsection (2) does not apply to the driver of an oversize vehicle, or the driver of a vehicle escorting or piloting an oversize vehicle, if—
 - (a) it is not practicable for the driver to comply with the provision; and
 - (b) the driver is taking reasonable care; and
 - (c) the driver is complying with—
 - (i) any guideline or permit applying to the movement of the vehicle under the Standards and Safety Regulation; or
 - (ii) any mass or dimension exemption applying to the movement of the vehicle under the Heavy Vehicle National Law (Queensland); and
 - (d) the vehicle is displaying an oversize warning sign.
- (2) For subsection (1), the provisions are as follows—
 - part 7 (Giving way), except—
 - section 67 (Stopping and giving way at a stop sign or stop line at an intersection without traffic lights)
 - section 68 (Stopping and giving way at a stop sign or stop line at other places)
 - section 69 (Giving way at a give way sign or give way line at an intersection, other than a roundabout)
 - section 70 (Giving way at a give way sign at a bridge or length of narrow road)
 - section 71 (Giving way at a give way sign or give way line at other places)

-
- part 8 (Traffic signs and road markings), except—
 - section 102 (Clearance and low clearance signs)
 - section 103 (Load limit signs)
 - section 111(3) (which is about entering a roundabout from the right marked lane or line of traffic)
 - section 116 (Obeying traffic lane arrows when driving in or leaving a roundabout)
 - part 11 (Keeping left, overtaking and other driving rules)
 - part 12 (Restrictions on stopping and parking)
 - section 268 (How persons must travel in or on a motor vehicle)
 - section 288 (Driving on a path)
 - section 289 (Driving on a nature strip)
 - section 290 (Driving on a traffic island)
 - section 296 (Driving a vehicle in reverse)
 - section 297(2) (which requires a driver to have a clear view of the surrounding road and traffic).

312 Exemption for tow truck drivers

- (1) It is a defence to the prosecution of the driver of a tow truck for an offence against a provision mentioned in subsection (2) if, at the time of the offence—
 - (a) the driver is engaged in loading, or connecting to, a vehicle to which this section applies; and
 - (b) the driver is unable to comply with the provision; and
 - (c) the tow truck is displaying a flashing light; and
 - (d) the driver is acting safely.
- (2) For subsection (1), the provisions are as follows—
 - part 4 (Making turns)

[s 313]

- part 6 (Traffic lights, traffic arrows and twin red lights)
 - part 7 (Giving way), division 1 (Giving way at a stop sign, stop line, give way sign or give way line applying to the driver)
 - part 8 (Traffic signs and road markings)
 - part 9 (Roundabouts)
 - part 11 (Keeping left, overtaking and other driving rules)
 - part 12 (Restrictions on stopping and parking)
 - section 288 (Driving on a path)
 - section 289 (Driving on a nature strip)
 - section 290 (Driving on a traffic island).
- (3) This section applies to the following vehicles—
- (a) a vehicle at the scene of a crash;
 - (b) a disabled vehicle;
 - (c) a vehicle unsafely or unlawfully parked that the driver is authorised to tow away under the Act or the Heavy Vehicle National Law (Queensland).

313 Exemption for postal vehicles

- (1) A provision mentioned in subsection (2) does not apply to the driver of a postal vehicle.
- (2) Subsection (1) applies to the following provisions—
- section 179 (Stopping in a loading zone)
 - section 180 (Stopping in a truck zone)
 - section 182 (Stopping in a taxi zone)
 - section 185 (Stopping in a permit zone)
 - section 186 (Stopping in a mail zone)
 - section 189 (Double parking)

-
- section 198 (Obstructing access to and from a footpath, driveway etc.).
- (3) Sections 288 and 289 do not apply to the driver of a postal vehicle if—
- (a) the postal vehicle is a motorbike with an engine capacity of 125mL or less; and
 - (b) the driver is driving the motorbike at a speed of 10km/h or less; and
 - (c) the driver drives in a way that does not cause danger to, or obstruct, anyone or anything on the path or nature strip; and
 - (d) the driver takes reasonable precautions to avoid crashing with anyone or anything on the path or nature strip.

313A Exemption for garbage truck drivers etc.

- (1) A provision mentioned in subsection (2) does not apply to the driver of a garbage truck, a waste disposal truck or a vehicle designed for collecting goods for recycling if—
- (a) the driver is engaged in the collection of garbage, waste or goods for recycling; and
 - (b) it is not practicable for the driver to comply with the provision; and
 - (c) the truck or vehicle is displaying a flashing light; and
 - (d) the driver is acting safely.
- (2) For subsection (1), the provisions are as follows—
- section 98 (One-way signs)
 - section 99 (Keep left and keep right signs)
 - section 100 (No entry signs)
 - part 12 (Restrictions on stopping and parking), except—
 - section 175 (Stopping on or near a level crossing)
 - section 177 (Stopping on a freeway)

[s 313B]

- section 178 (Stopping in an emergency stopping lane)
- section 192 (Stopping on a bridge or in a tunnel etc.)
- section 196 (Stopping at or near a tram stop)
- section 197 (Stopping on a path, dividing strip, nature strip or painted island)
- section 228 (No pedestrian signs)
- section 230 (Crossing a road—general)
- section 234 (Crossing a road on or near a crossing for pedestrians)
- section 238 (Pedestrians travelling along a road (except in or on a wheeled recreational device or toy)).

313B Exemption for breakdown vehicles

- (1) A provision mentioned in subsection (2) does not apply to the driver of a breakdown vehicle while—
 - (a) the driver is engaged in repairing a disabled vehicle or is assisting a person to gain access to a locked vehicle; and
 - (b) the driver is unable to comply with the provision; and
 - (c) the breakdown vehicle is displaying a flashing light; and
 - (d) the driver is acting safely.
- (2) For subsection (1), the provisions are as follows—
 - section 137 (Keeping off a dividing strip)
 - section 138 (Keeping off a painted island)
 - section 147 (Moving from 1 marked lane to another marked lane across a continuous line separating the lanes)
 - section 197 (Stopping on a path, dividing strip, nature strip or painted island)
 - section 288(1) (Driving on a path)

-
- section 289 (Driving on a nature strip)
 - section 290 (Driving on a traffic island).
- (3) In this section—
- breakdown vehicle*** means any vehicle driven by a person who is—
- (a) a breakdown worker; and
 - (b) driving the vehicle in the course of performing duties as a breakdown worker.
- breakdown worker*** means a person who attends disabled vehicles as part of the person's employment for the purpose of repairing the disabled vehicle.

Part 20 Traffic control devices and traffic-related items

Division 1 General

314 Diagrams of traffic control devices, traffic-related items and symbols

- (1) A diagram in this regulation of a traffic control device, traffic-related item, or symbol represents a likeness of the device, item or symbol.
- (2) If there are 2 or more diagrams of a traffic sign in schedules 2 and 3 or of a traffic-related item or symbol in schedule 4, each diagram represents a likeness of a permitted version of the sign, item or symbol.
- (3) If a diagram of a traffic sign in schedule 2 or 3 or of a traffic-related item or symbol in schedule 4 is in black and white, the permitted version of the sign, item or symbol is in black and white only.

[s 315]

- (4) If a diagram of a traffic sign, traffic-related item or symbol in a section of this regulation is in black and white and the sign, item or symbol is not in black and white only in schedule 2, 3 or 4, the diagram is a black and white representation of the sign, item or symbol and is not a permitted version of the sign, item or symbol.

315 Legal effect of traffic control devices

- (1) A traffic control device of a kind mentioned in this regulation has effect for this regulation if—
 - (a) the device is on a road; and
 - (b) the device complies substantially with this regulation.
- (2) A traffic control device is taken to comply substantially with this regulation unless the contrary is proved.

316 When do traffic control devices comply substantially with this regulation

- (1) A traffic sign complies substantially with this regulation if—
 - (a) it is a reasonable likeness of a diagram in schedule 2 or 3 of that kind of traffic sign; or
 - (b) for a traffic sign of a kind for which there is not a diagram in schedule 2 or 3—it complies substantially with a description of that kind of traffic sign in this regulation and, if the description includes a symbol for which there is a diagram in schedule 4, the symbol on the sign is a reasonable likeness of the diagram.
- (2) A road marking complies substantially with this regulation if it complies substantially with a description of that kind of road marking in this regulation and, if the description includes a symbol for which there is a diagram in schedule 4, the symbol in the road marking is a reasonable likeness of the diagram.
- (3) A traffic control device (except a traffic sign or a road marking) complies substantially with this regulation if the

device complies substantially with a description of that kind of traffic control device in this regulation and, if the description includes a symbol for which there is a diagram in schedule 4, the symbol on the device is a reasonable likeness of the diagram.

Example—

A red and white post temporarily missing from a children's crossing complies substantially with the description of a children's crossing under section 80(6).

- (4) A traffic sign may be a reasonable likeness of a diagram of a kind of traffic sign mentioned in this regulation even though—
- (a) the dimensions of the sign, or of anything on the sign, are different; or
 - (b) the sign has additional information on or with it; or
 - (c) the number on the sign is different; or
 - (d) the sign has a different number of panels; or
 - (e) the sign is combined on a single panel with 1 or more other traffic signs; or
 - (f) for a parking control sign—words, figures, symbols, or anything else, on the sign are differently arranged; or
 - (g) for a bus lane sign, emergency stopping lane only sign, one-way sign or parking control sign—the sign has an arrow pointing in a different direction; or
 - (h) for a separated footpath sign or an end separated footpath sign—the pedestrian and bicycle symbols are reversed; or
 - (i) for a road access sign—information on or with the sign indicates (whether by different wording or in another way) that it applies to different or additional vehicles or persons; or
 - (j) there is a variation in shade or brightness between a colour on the sign and the equivalent colour in the diagram.

[s 316]

Example for subsection (4)(b)—

A speed limit sign near a school may say that the sign has effect at certain times. This additional information does not prevent the sign being a reasonable likeness of the diagram of a speed limit sign in schedule 2.

Example for subsection (4)(c)—

The diagram of the area speed limit sign in schedule 2 has the number '60'. A particular area speed limit sign may have another number, for example, '50'. The different number on the sign does not prevent the sign being a reasonable likeness of the diagram.

Examples for subsection (4)(d)—

- 1 A school zone sign may have the indicated speed limit, the words 'school zone', and the times of operation, on a single panel or separate panels.
- 2 An end bicycle path sign may have the word 'end' on a separate panel or on the same panel as the rest of the sign.

Example for subsection (4)(e)—

A no parking sign that operates at certain times may be combined on a single panel with a permissive parking sign allowing pay parking at other times.

Example for subsection (4)(f)—

A permissive parking sign limiting parking to 2 hours may have the time limit above, or below, the word 'parking'.

Example for subsection (4)(i)—

The diagram of the road access sign in schedule 2 says 'no pedestrians bicycles animals beyond this point'. The replacement of the word 'bicycles' by the word 'tractors' on a particular sign does not prevent the sign being a reasonable likeness of the diagram.

- (5) A variable illuminated message sign may also be a reasonable likeness of a diagram of a kind of traffic sign in schedule 2 or 3 even though the colour of the sign, or of anything else on the sign, is different.

Example of standard sign and variable illuminated message sign—



Speed limit sign (Standard sign)



Speed limit sign (Variable illuminated message sign)

- (6) A symbol on or in a traffic control device may be a reasonable likeness of a diagram of a kind of symbol mentioned in this regulation even though the dimensions of the symbol, or of anything on the symbol, are different.
- (7) In this section—
panel includes a board, plate and screen.

317 Information on or with traffic control devices

- (1) A traffic control device may, by the use of words, figures, symbols or anything else indicate any of the following—
- (a) the times, days or circumstances when it applies or does not apply;
 - (b) the lengths of road or areas where it applies or does not apply;
 - (c) the persons to whom it applies or does not apply;
 - (d) the vehicles to which it applies or does not apply;
 - (e) other information.

Examples of circumstances—

- 1 A speed limit sign may indicate that it applies when the lights at a children's crossing are flashing.
- 2 A speed limit sign may indicate that it applies when children are present.

[s 318]

(2) In this section—

traffic control device includes a board, device, plate, screen, word, figure, symbol, or anything else, with a traffic control device that provides information about the application of the traffic control device.

Examples of information with a traffic control device—

- a plate erected immediately below a no U-turn sign indicating that the sign applies on Monday to Friday between 8a.m. and 6p.m.
- an illuminated board erected close to, but not next to, a no entry sign indicating that commercial trucks are permitted to pass the sign when the words on the board are illuminated

318 Limited effect of certain traffic control devices

(1) If information on a traffic control device indicates that the device applies during particular times, on particular days, in particular circumstances, to a particular length of road or area, or to particular persons or vehicles, the device has effect only for the indicated times, days, circumstances, length of road, area, persons or vehicles.

Example—

a shared zone sign on a road into an area indicating that the sign applies on Monday to Friday between 7a.m. and 6p.m.

(2) If information on a traffic control device indicates that the device does not apply during particular times, on particular days, in particular circumstances, to a particular length of road or area, or to particular persons or vehicles, the device does not have effect for the indicated times, days, circumstances, length of road, area, persons or vehicles.

Examples—

- a plate erected next to a pedestrian crossing sign at a place indicating that the sign does not apply on a particular day
- a board erected close to a bus lane sign above a marked lane indicating that the sign does not apply when the words on the board are illuminated

(3) If information on a traffic control device that is at a place indicates that it applies on a particular day of the week, the

device does not have effect on a day that is a public holiday for the place unless information on the device states otherwise.

Example—

If a loading zone sign indicates that it applies on Monday to Friday between 9a.m. and 4p.m. and information on or with the sign does not indicate that it applies on public holidays, the sign does not have effect on any public holiday falling on a Monday to Friday.

(4) In this section—

traffic control device includes a board, device, plate, screen, word, figure, symbol, or anything else, with a traffic control device that provides information about the application of the traffic control device.

319 Legal effect of traffic-related items mentioned in this regulation

- (1) A traffic-related item of a kind mentioned in this regulation has effect for this regulation if—
 - (a) the item is on a road or on a vehicle on a road; and
 - (b) the item complies substantially with this regulation.
- (2) A traffic-related item is taken to comply with this regulation unless the contrary is proved.

320 When do traffic-related items comply substantially with this regulation

- (1) A traffic-related item complies substantially with this regulation if—
 - (a) it is a reasonable likeness of a diagram in schedule 4 of that kind of traffic-related item; or
 - (b) for a traffic-related item of a kind for which there is not a diagram in schedule 4—
 - (i) it complies substantially with a description of that kind of traffic-related item in this regulation; and

[s 321]

- (ii) if the description includes a symbol for which there is a diagram in schedule 4, the symbol on the item is a reasonable likeness of the diagram.
- (2) A traffic-related item may be a reasonable likeness of a diagram of a kind of traffic-related item mentioned in this regulation even though—
 - (a) the dimensions of the item or of anything on the item are different; or
 - (b) the item has additional information.
- (3) A symbol on a traffic-related item may be a reasonable likeness of a diagram of a kind of symbol mentioned in this regulation even though the dimensions of the symbol or of anything on the symbol are different.

321 Meaning of information on or with traffic control devices and traffic-related items

A word, figure, symbol or anything else used on or with a traffic control device or traffic-related item has the same meaning as in this regulation.

322 Reference to traffic control devices and traffic-related items on a road etc.

- (1) A traffic control device or traffic-related item above or near a road is taken to be on the road.

Examples—

- 1 A speed limit sign erected on a post at the side of a road is taken to be a speed limit sign on the road.
 - 2 A traffic lane arrow on a structure immediately above the road is taken to be a traffic lane arrow on the road.
 - 3 A do not overtake turning vehicle sign attached to a vehicle on a road is taken to be a do not overtake turning vehicle sign on the road.
- (2) However, the device or item is taken to be on the road only if it is clearly visible to road users to whom it is designed to apply.

Example—

A shared zone sign erected on a post near the side of a road is a traffic sign on the road only if it is clearly visible to drivers driving on the road during the day and in normal weather conditions.

- (3) A traffic control device or traffic-related item above or near an area or place is taken to be in or at the area or place.

Examples—

- 1 Traffic lights erected outside the area of an intersection, but near that area, are taken to be traffic lights at the intersection.
 - 2 A hook turn only sign fixed to a structure above a road that is close to, but before, an intersection is taken to be a hook turn only sign at the intersection.
 - 3 A parking control sign near the side of a road is taken to be at the side of the road.
 - 4 A parking control sign near the centre of a road is taken to be at the centre of the road.
- (4) However, the device or item is taken to be in or at the area or place only if it is clearly visible to road users to whom it is designed to apply.

Example—

A no right turn sign suspended from wires above a road close to, but before, an intersection is a traffic sign at the intersection only if it is clearly visible to drivers approaching the intersection during the day and in normal weather conditions.

- (5) Without limiting subsection (3), a traffic control device or traffic-related item above or near a break in a dividing strip is taken to be at the break.

Example—

A no U-turn sign erected in a dividing strip close to, but before, a break in the dividing strip is taken to be at the break.

- (6) However, the device or item is taken to be at the break only if it is clearly visible to road users to whom it is designed to apply.
- (7) A traffic control device or traffic-related item is taken to comply with subsection (2), (4) or (6) unless the contrary is proved.

[s 323]

(8) In this section—

clearly visible means—

- (a) for a traffic signal—clearly visible during the day and night in normal weather conditions; or
- (b) for another traffic control device or a traffic-related item—clearly visible during the day in normal weather conditions.

day means the period between sunrise on a day and sunset on the same day.

normal weather conditions means weather conditions that are not hazardous weather conditions causing reduced visibility.

323 References to lights that are traffic signals

A reference in this regulation to a light that is, or is part of, traffic signals is a reference to a steady light, unless otherwise expressly stated.

323A Audible lines

- (1) An audible line is a line on a road that is made up of a series of closely spaced raised pieces of material designed to create a continuous noise or vibration if driven on by a motor vehicle.
- (2) A reference in this regulation to a line is to be taken to include a reference to an audible line, unless otherwise expressly stated.
- (3) For the purposes of this regulation—
 - (a) an audible line is taken to be continuous even if there is no physical link between the pieces of material making up the line; and
 - (b) if there is no physical link between those pieces, the colour of the audible line is taken to be the visible colour of those pieces.

Division 2 Application of traffic control devices to lengths of roads and areas

324 Purpose of division

- (1) This division contains rules explaining when traffic control devices apply to lengths of road and areas.
- (2) Other relevant rules are found elsewhere in this regulation.

325 References to traffic control devices—application to lengths of road and areas

In applying this regulation to a length of road or an area, unless the contrary intention appears, a reference to a traffic control device is a reference to a traffic control device applying to the length of road or area.

326 When do traffic control devices apply to a length of road or area—the basic rules

- (1) A traffic control device applies to a length of road or an area if—
 - (a) the device applies to the length of road or area under 1 or more provisions of this regulation; or
 - (b) the device, the position of the device, or information on or with the device indicates that the device applies to the length of road or area.
- (2) A traffic control device does not apply to a length of road or an area if information on or with the device expressly indicates that it does not apply to the length of road or area.
- (3) Subsection (2) applies despite any other provision of this division.
- (4) In subsection (1)(b)—
the device includes another traffic control device.

[s 327]

327 Length of road to which a traffic sign (except a parking control sign) applies

The length of road to which a traffic sign on a road (except a parking control sign) applies is worked out in the direction driven by a driver, or travelled by a pedestrian, on the road who faces the sign before passing it.

Example—

Section 21(2) provides that a speed limit sign applies to the length of road beginning at the sign and ending at the nearest of a different speed limit sign, an end speed limit sign or speed derestriction sign, or the end of the road. Only the nearest of those things, in the direction driven by a driver, or travelled by a pedestrian, who faces the sign before passing it, is relevant.

328 References to a traffic control device applying to a length of road

If, under this regulation, a traffic control device on a road applies to a length of road, the device applies only to a length of road on that road, unless otherwise expressly stated.

Example—

A speed limit sign on a road does not apply to roads leading off from the road.

329 Traffic control devices applying to a marked lane

- (1) A traffic control device (except a road marking) applies to a marked lane if—
 - (a) it is above the marked lane; or
 - (b) it is near the marked lane and the device, the position of the device, or information on or with the device indicates that it applies to the marked lane.

Example—

An emergency stopping lane only sign applies to the marked lane indicated by the arrow on the sign.

- (2) A road marking applies to a marked lane if it is on the surface of the lane.

-
- (3) However, a traffic control device does not apply to a marked lane if information on or with the device expressly indicates that the device does not apply to the marked lane.
 - (4) In subsection (1)(b)—
the device includes another traffic control device.

330 Traffic control devices applying to a slip lane

- (1) A traffic control device (except a road marking) applies to a slip lane if—
 - (a) it is above the slip lane; or
 - (b) it is near the slip lane and on the left side of the slip lane;
or
 - (c) it is near the slip lane and the device, the position of the device, or information on or with the device indicates that it applies to the slip lane.
- (2) A road marking applies to a slip lane if it is on the surface of the slip lane.
- (3) However, a traffic control device does not apply to a slip lane if information on or with the device expressly indicates that the device does not apply to the slip lane.
- (4) In subsection (1)(c)—
the device includes another traffic control device.

331 Traffic control devices applying to an intersection

A traffic control device—

- (a) applies to an intersection if it is at the intersection; and
- (b) does not apply to a slip lane at the intersection, unless information on or with the device expressly indicates that the device does not apply to the intersection.

[s 332]

332 Parking control signs applying to a length of road

- (1) If a parking control sign displays an arrow and is at the side of a road, then, unless information on or with the sign indicates otherwise, the sign applies to the length of road between the sign and the nearest (in the direction indicated by the arrow) of the following—
 - (a) a parking control sign at that side of the road that displays an arrow indicating the opposite direction;
 - (b) a yellow edge line on the road;
 - (c) if the road ends at a T-intersection or dead end—the end of the road.
- (2) If a parking control sign displays an arrow and is at the centre of a road or on a dividing strip, then, unless information on or with the sign indicates otherwise, the sign applies to the length of road between the sign and the nearest (in the direction indicated by the arrow) of the following—
 - (a) a parking control sign at that side of the road that displays an arrow indicating the opposite direction;
 - (b) a yellow edge line on the road;
 - (c) if the road ends at a T-intersection or dead end—the end of the road.

333 Parking control signs applying to a length of road in an area to which another parking control sign applies etc.

- (1) If a parking control sign applying to a length of road is in an area to which another parking control sign applies in accordance with section 335, the first parking control sign applies in the same way as it would apply if it were not in that area, and the second parking control sign does not apply to the length of road.

Example—

Parking control signs that establish a loading zone or taxi zone may operate on a length of road in an area where parking is otherwise restricted to residents only by other parking control signs on each road into the area.

- (2) If the area indicated by a people with disabilities road marking is in an area to which a parking control sign applies in accordance with section 335, the road marking applies in the same way as it would apply if it were not in that area, and the parking control sign does not apply to the area indicated by the road marking.

334 How parking control signs apply to a length of road

- (1) If a permissive parking sign, bicycle parking sign, motorbike parking sign, or a parking control sign for a zone mentioned in part 12, division 5, applies to a length of road and there are parking bays on the length of road, the sign applies only to the parking bays, unless information on or with the sign indicates otherwise.
- (2) If a parking control sign applies to a length of road, the sign is at the side of the road, and there are no parking bays to which the sign applies, then, unless information on or with the sign indicates otherwise, the sign applies to—
 - (a) any shoulder of the road on that side of the road; and
 - (b) the part of the road on the length of road extending from the far side of the road (excluding any road-related area) on that side of the road for—
 - (i) if the sign, or information on or with the sign, includes the words ‘angle parking’ or ‘angle’—6 metres; or
 - (ii) in any other case—3 metres.

[s 335]

Examples—

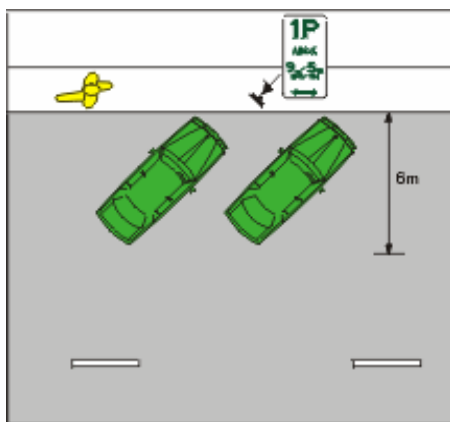

Example 1

Part of a road to which a parking control sign indicating angle parking applies

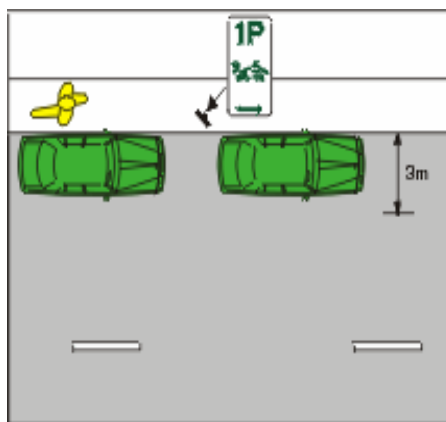

Example 2

Part of a road to which a parking control sign (except a sign indicating angle parking) applies

- (3) If a parking control sign applies to a length of road, the sign is at the centre of the road or on a dividing strip, and there are no parking bays to which the sign applies, then, unless information on or with the sign indicates otherwise, the sign applies to—
 - (a) if the sign is at the centre of the road, but not on a dividing strip—the part of the road on that length of road extending 3m from the centre of the road on each side of the road; or
 - (b) if the sign is on a dividing strip—the dividing strip on that length of road and the part of the road extending 3m from each edge of the dividing strip.

335 Traffic control devices applying to an area

- (1) A traffic control device (except a road marking) applies to an area if—

-
- (a) it is in the area; and
 - (b) the device, the position of the device, or information on or with the device indicates that the device applies to the area.
- (2) A traffic control device (except a road marking) also applies to an area if—
- (a) there is an identical kind of traffic control device (the *first traffic control device*) on each road into the area; and
 - (b) the traffic control device is a traffic control device applying to an area, or information on or with the device indicates that it applies to an area; and
 - (c) information on or with a traffic control device on each road out of the area indicates that the first traffic control device no longer applies or that the area has ended.

Examples of traffic control devices applying to an area—

- a shared zone sign
 - a no stopping sign or no parking sign with the word ‘area’
 - a permissive parking sign with the words ‘parking area’
 - an end no parking area sign
 - an end no stopping area sign
 - an end parking area sign
- (3) A road marking applies to an area if—
- (a) it is on the surface of the area; and
 - (b) the road marking, the position of the road marking, or information in or with the road marking indicates that the road marking applies to the area.
- (4) However, a traffic control device does not apply to an area if information on or with the device expressly indicates that the device does not apply to the area.
- (5) A parking control sign that applies to an area applies to parking bays on each length of road in the area, and to other

[s 336]

parts of each length of road, as if it were a parking control sign applying only to that length of road.

(6) In this section—

road, in subsection (2)(a) and (c) and for an area of road, does not include a road-related area.

the device, in subsection (1)(b), includes another traffic control device.

the road marking, in subsection (3)(b), includes another traffic control device.

336 How separated footpath signs and separated footpath road markings apply

(1) A separated footpath sign, or separated footpath road marking, on a footpath applies in the way set out in this section.

(2) The part of the footpath to the left of the centre of the footpath is designated—

(a) if a pedestrian symbol is on the left side of the sign or the path—for the use of pedestrians; or

(b) if a bicycle symbol is on the left side of the sign or the path—for the use of bicycles.

(3) The part of the footpath to the right of the centre of the footpath is designated—

(a) if a pedestrian symbol is on the right side of the sign or the path—for the use of pedestrians; or

(b) if a bicycle symbol is on the right side of the sign or the path—for the use of bicycles.

(4) A person using a personal mobility device may use any part of a separated footpath, regardless of whether the part is designated for the use of pedestrians or bicycles.

(5) In this section—

pedestrian does not include a person using a personal mobility device.

Division 3 Application of traffic control devices to persons

337 Purpose of division

This division explains when a traffic control device applies to a person.

338 References to traffic control devices—application to persons

In applying this regulation to a person, unless the contrary intention appears, a reference to a traffic control device is a reference to a traffic control device applying to the person.

339 When do traffic control devices apply to a person—the basic rules

- (1) A traffic control device applies to a person if—
 - (a) the device applies to the person under a provision of this division; or
 - (b) the device, the position of the device, or information on or with the device indicates that the device applies to the person.
- (2) A traffic control device does not apply to a person if information on or with the device expressly indicates that it does not apply to the person.
- (3) Subsection (2) applies despite any other provision of this division.
- (4) In subsection (1)(b)—

the device includes another traffic control device.

[s 340]

340 Traffic control devices (except road markings and parking control signs)

- (1) A traffic control device (except a road marking or parking control sign) applies to a person if—
 - (a) the device faces the person; or
 - (b) the person has passed the device and the device faced the person as the person approached it.
- (2) However, the device does not apply to the person if the position of the device indicates that it does not apply to the person.

Examples—

- 1 If a driver is driving in a marked lane of a multi-lane road, a traffic lane arrow above another marked lane does not apply to the driver.
- 2 If a driver is turning left using a slip lane at an intersection, a traffic light on the right side of the painted island or traffic island that separates the slip lane from other parts of the road does not apply to the driver.
- 3 If a driver is driving on a two-way road, a speed limit sign facing only traffic travelling in the opposite direction does not apply to the driver.

341 Road markings

A road marking on the surface of a road applies to a person on the road unless the position of the road marking indicates that it does not apply to the person.

Examples—

- 1 If a driver is driving on a road that is not a multi-lane road or one-way road, a road marking to the right of the centre of the road does not apply to the driver.
- 2 If a driver is driving in a marked lane of a multi-lane road, a road marking in another marked lane does not apply to the driver.
- 3 At an intersection, or on a roundabout, road markings indicating the edge of a marked lane for use by traffic coming from a particular direction do not apply to a driver coming from another direction.

342 Traffic signs (except parking control signs) applying to a length of road

- (1) A traffic sign (except a parking control sign) applying to a length of road and to drivers applies to a driver driving on the length of road if the driver is driving in the same direction as a driver on the road who faces the sign before passing it.
- (2) A traffic sign applying to a length of road and to pedestrians applies to a pedestrian travelling on the length of road if the pedestrian is travelling in the same direction as a pedestrian on the road who faces the sign before passing it.
- (3) The traffic sign applies to the driver or pedestrian even though the driver or pedestrian does not pass the sign.

Example—

If a driver turns from a side road or private land onto a length of road to which a traffic sign applies, the traffic sign applies to the driver even though the driver does not pass the sign.

- (4) Subsections (1) to (3) do not affect the operation of the Criminal Code, section 24.

Editor's note—

Criminal Code, section 24 (Mistake of fact)

343 Traffic signs (except parking control signs) applying to an area

- (1) A traffic sign (except a parking control sign) applying to an area and to drivers applies to a driver driving on any road in the area.
- (2) A traffic sign applying to an area and to pedestrians applies to a pedestrian on any road in the area.
- (3) The traffic sign applies to the driver or pedestrian even though the driver or pedestrian does not pass the sign.

Example—

The shared zone signs on the roads into a shared zone apply to a driver who starts a journey inside the shared zone.

[s 344]

- (4) Subsections (1) to (3) do not affect the operation of the Criminal Code, section 24.

344 Traffic control devices applying to a driver in a marked lane

A traffic control device applying to a marked lane applies to a driver approaching, in or leaving the marked lane unless the position of the device indicates that it does not apply to the driver.

Example—

An overhead lane control device above a marked lane that the driver does not face as the driver approaches it does not apply to the driver.

345 Traffic control devices applying to a driver in a slip lane

A traffic control device applying to a slip lane applies to a driver approaching, in or leaving the slip lane.

346 Parking control signs

- (1) A parking control sign applying to a length of road applies to a driver on the length of road.
- (2) A parking control sign applying to an area applies to a driver in the area.
- (3) A parking control sign applies to a driver mentioned in subsection (1) or (2) even though the driver does not pass the sign.
- (4) Subsections (1) to (3) do not affect the operation of the Criminal Code, section 24.

Part 21 General

347 **Meaning of abbreviations and symbols**

Schedule 1 provides the meaning of certain abbreviations and symbols used in this regulation and on traffic control devices and traffic-related items.

348 **References to a driver doing something etc.**

If the context permits, a reference in this regulation to a driver doing or not doing something is a reference to the driver causing the driver's vehicle to do or not to do the thing.

Example—

The reference in section 27 to a driver turning left at an intersection is a reference to the driver causing the driver's vehicle to turn left at the intersection.

349 **References to certain kinds of roads**

A reference in this regulation to a road of a particular kind is a reference to a road of that kind at any relevant place.

Example—

Section 31 deals with a driver starting a right turn at an intersection from a road (except a multi-lane road). The section applies to a particular driver only if the road from which the driver is turning is not a multi-lane road at the intersection. In applying the section to the driver, it is irrelevant that the road is, or is not, a multi-lane road at another place away from the intersection.

350 **References to stopping or parking on a length of road etc.**

- (1) A driver stops or parks on a length of road or in an area if the driver stops or parks the driver's vehicle so any part of the vehicle is on the length of road or in the area.
- (2) A driver stops or parks within a particular distance from, before, or after, something if the driver stops or parks the

[s 351]

driver's vehicle so any part of the vehicle is within that distance.

Example for subsection (2)—

Section 190 provides that a driver must not stop on a road within 10m before or after a safety zone. The example diagram in section 190 shows a vehicle stopped so part of the vehicle is within 10m of the zone. For section 190, the vehicle is taken to be stopped within 10m of the zone.

- (3) A driver stops or parks on or across a driveway or other way of access for vehicles if the driver stops or parks the vehicle so that any part of the vehicle is on or across the driveway or way of access.
- (4) In this section—
park has the same meaning as in part 12.
stop has the same meaning as in part 12.

351 References to left and right

A driver drives to the left, or right, of a line, sign or anything else only if the driver's vehicle is completely to the left, or right, of the line, sign or other thing.

352 References to stopping as near as practicable to a place

A requirement in this regulation for a driver to stop as near as practicable to a place is not complied with only because the driver stops behind a vehicle that has stopped at the place.

Example—

If a driver stops behind a vehicle that has stopped at a stop sign or stop line in accordance with section 67, 68 or 121, the driver must, after the vehicle has proceeded, stop at the stop sign or stop line in accordance with the section.

352A Giving way to pedestrians crossing a road

- (1) This section applies to a driver at an intersection who is required, under a relevant provision, to give way to a

pedestrian who is crossing the road, or part of the road, the driver is entering.

(2) The driver is required to give way to the pedestrian only if the pedestrian's line of travel in crossing the road, or part of the road, the driver is entering is essentially at right angles to the edges of the road, or part of the road.

(3) In this section—

relevant provision means any of the following—

- (a) section 62(1)(a);
- (b) section 64(b);
- (c) section 67(4);
- (d) section 69(3);
- (e) section 72(3)(b) or (5)(c);
- (f) section 73(2)(b), (4) or (6)(b).

353 Prescribed offences for ch 5, pt 7 of the Act

For chapter 5, part 7 of the Act, offences against the following provisions are prescribed offences—

- (a) section 20;
- (b) section 56(1) and (2);
- (c) section 104(1), (2) and (3);
- (d) section 84A(1) of the Act;
- (e) the *Transport Operations (Road Use Management—Vehicle Registration) Regulation 2010*, sections 11 and 127(2)(f);
- (f) the *Motor Accident Insurance Act 1994*, section 20(1) and (2).

353AA Prescribed offences for the Act, s 113A(2)(a) and (b)

For section 113A(2)(a) and (b) of the Act, offences against the following provisions are prescribed offences—

[s 353A]

- (a) the *Transport Operations (Road Use Management—Vehicle Registration) Regulation 2010*, section 11;
- (b) the *Motor Accident Insurance Act 1994*, section 20(1) and (2).

353A People with disabilities symbols—Act, sch 4, definition *people with disabilities symbol*

For the Act, schedule 4, definition *people with disabilities symbol*, the following symbols are prescribed—



353B Power-assisted bicycles—Act, sch 4, definition *power-assisted bicycle*

- (1) This section prescribes, for the Act, schedule 4, definition *power-assisted bicycle*, vehicles that are, and vehicles that are not, power-assisted bicycles.
- (2) A vehicle mentioned in the Act, schedule 4, definition *power-assisted bicycle*, paragraph (a)(i) is a power-assisted bicycle if it—
 - (a) is a pedalec; or
 - (b) has 1 or more electric motors with a maximum power output, or combined maximum power output, of not more than 200 watts.

- (3) A vehicle mentioned in the Act, schedule 4, definition *power-assisted bicycle*, paragraph (a)(i) is not a power-assisted bicycle if it has an internal combustion engine.
- (4) In this section—
pedalec has the meaning given by the *Vehicle Standard (Australian Design Rule—Definitions and Vehicle Categories) 2005* (Cwlth).

Part 22 Repeal and transitional provisions

354 Repeal

The Transport Operations (Road Use Management—Road Rules) Regulation 1999, SL No. 246 is repealed.

355 Continuation of Transport Operations (Road Use Management—Road Rules) Regulation 1999, s 266

Despite the repeal of the *Transport Operations (Road Use Management—Road Rules) Regulation 1999*, section 266 of that regulation continues in force until the end of 10 March 2010.

356 References to Transport Operations (Road Use Management—Road Rules) Regulation 1999

A reference in an Act or other document to the *Transport Operations (Road Use Management—Road Rules) Regulation 1999* is, if the context permits, taken to be a reference to this regulation.





Schedule 1 Abbreviations and symbols

section 347





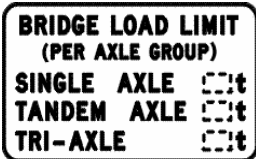

Abbreviation/Symbol	Meaning
MON	Monday
TUE	Tuesday
WED	Wednesday
THU	Thursday
FRI	Friday
SAT	Saturday
SUN	Sunday
JAN	January
FEB	February
MAR	March
APR	April
JUN	June
JUL	July
AUG	August
SEP	September
OCT	October
NOV	November
DEC	December
AM or A.M.	the time after midnight and ending at midday
PM or P.M.	the time after midday and ending at midnight
HOLS	holidays
MAX	maximum
MINS	minutes
PUB	public
VEH	vehicle







Schedule 2 Standard or commonly used traffic signs

sections 314 and 316

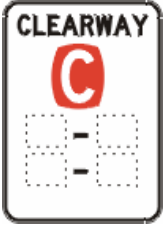
<p>Area speed limit sign (section 22)</p> 	<p>Bicycle lane sign (sections 153, 252)</p> 
<p>Bicycle parking sign (section 201)</p> 	<p>Bicycle path sign (sections 239, 242, 252)</p> 
<p>Bridge load limit (gross mass) sign (section 103)</p> 	<p>Bridge load limit (mass per axle group) sign (section 103)</p> 







Schedule 2

<p>Buses must enter sign (section 107)</p> 	<p>Bus lane sign (section 154)</p> 
<p>Bus zone sign (section 183)</p> 	<p>Children crossing flag (section 80)</p> 
<p>Children's crossing sign (section 80)</p> 	<p>Clearance sign (section 102)</p> 







<p style="text-align: center;">Clearway sign (section 176)</p> 	<p style="text-align: center;">Clearway sign (section 176)</p> 
<p style="text-align: center;">End area speed limit sign (section 22)</p> 	<p style="text-align: center;">End area speed limit sign (section 22)</p> 
<p style="text-align: center;">End bicycle path sign (section 239)</p> 	<p style="text-align: center;">End bus lane sign (section 154)</p> 









Schedule 2

<p>End clearway sign (section 176)</p> 	<p>End freeway sign (sections 97, 177)</p> 
<p>End keep left unless overtaking sign (section 130)</p> 	<p>End no bicycles sign (section 252)</p> 
<p>End no overtaking or passing sign (section 93)</p> 	<p>End no parking area sign (section 335)</p> 



<p>End no stopping area sign (section 335)</p> 	<p>End parking area sign (section 335)</p> 
<p>End road access sign (section 97)</p> 	<p>End school zone sign (section 23)</p> 
<p>End separated footpath sign (section 239)</p> 	<p>End shared path sign (section 242)</p> 







Schedule 2

<p style="text-align: center;">End shared zone sign (section 24)</p> 	<p style="text-align: center;">End speed limit sign (section 21)</p> 
<p style="text-align: center;">End tram lane sign (section 155)</p> 	<p style="text-align: center;">End transit lane sign (End transit lane (T2) sign) (section 156)</p> 
<p style="text-align: center;">End transit lane sign (End transit lane (T3) sign) (section 156)</p> 	<p style="text-align: center;">End trucks and buses low gear sign (section 108)</p> 

<p>End truck lane sign (section 157)</p> 	<p>End trucks use left lane sign (section 159)</p> 
<p>Freeway sign (section 177)</p> 	<p>Freeway sign (section 177)</p> 
<p>Give way sign (sections 69, 70, 71, 122)</p> 	<p>Gross load limit sign (section 103)</p> 
<p>Hand-held stop sign (section 80)</p> 	<p>Hand-held stop sign (section 80)</p> 

Schedule 2

<p>Hook turn only sign (section 34)</p> 	<p>Keep left sign (section 99)</p> 
<p>Keep left unless overtaking sign (section 130)</p> 	<p>Keep right sign (sections 99, 135)</p> 
<p>Left lane must turn left sign (section 88)</p> 	<p>Left turn only sign (section 88)</p> 

<p>Left turn on red after stopping sign (section 59)</p> 	<p>Level crossing sign (section 120)</p> 
<p>Level crossing sign (section 120)</p> 	<p>Level crossing sign (section 120)</p> 
<p>Loading zone sign (section 179)</p> 	<p>Low clearance sign (section 102)</p> 

Schedule 2

<p style="text-align: center;">Mail zone sign (section 186)</p> 	<p style="text-align: center;">Median turning lane sign (section 86)</p> 
<p style="text-align: center;">Motorbike parking sign (section 202)</p> 	<p style="text-align: center;">No bicycles sign (sections 239, 242, 252)</p> 
<p style="text-align: center;">No buses sign (section 106)</p> 	<p style="text-align: center;">No entry sign (section 100)</p> 
<p style="text-align: center;">No hook turn by bicycles sign (section 36)</p> 	<p style="text-align: center;">No left turn sign (Standard sign) (section 91)</p> 







<p>No left turn sign (Variable illuminated message sign) (section 91)</p> 	<p>No overtaking on bridge sign (section 94)</p> 
<p>No overtaking or passing sign (section 93)</p> 	<p>No parking sign (for a length of road) (section 168)</p> 
<p>No parking sign (for an area) (section 168)</p> 	<p>No pedestrians sign (section 228)</p> 







Schedule 2

<p>No right turn sign (Standard sign) (section 91)</p> 	<p>No right turn sign (Variable illuminated message sign) (section 91)</p> 
<p>No stopping sign (for a length of road) (section 167)</p> 	<p>No stopping sign (for an area) (section 167)</p> 
<p>No trucks sign (section 104)</p> 	<p>No turns sign (section 90)</p> 

<p>No U-turn sign (Standard sign) (section 39)</p> 	<p>No U-turn sign (Variable illuminated message sign) (section 39)</p> 
<p>One-way sign (section 98)</p> 	<p>One-way sign (section 98)</p> 
<p>Park in bays only sign (section 211)</p> 	<p>Pedestrian crossing sign (section 81)</p> 

Schedule 2

<p>Pedestrians may cross diagonally sign (sections 230, 234)</p> 	<p>People with disabilities parking sign (section 203)</p> 
<p>Permissive parking sign (for a length of road) (section 204)</p> 	<p>Permissive parking sign (for a length of road) (section 204)</p> 
<p>Permissive parking sign (for an area) (section 204)</p> 	<p>Permissive parking sign displaying a people with disabilities symbol (for a length of road) (section 203)</p> 







<p>Permissive parking sign displaying a people with disabilities symbol (for an area) (section 203)</p>  <p>A rectangular sign with a white background. At the top, it says "PARKING AREA" in black. Below that is a dashed rectangular box containing a green letter "P". Underneath the "P" is a purple square with a white wheelchair symbol. At the bottom, it says "ONLY" in black.</p>	<p>Permit zone sign (section 185)</p>  <p>A rectangular sign with a white background. At the top, there is a red rectangular box with the words "PERMIT ZONE" in white. Below this box is a red arrow pointing to the left.</p>
<p>Right lane must turn right sign (section 89)</p>  <p>A rectangular sign with a black border and a white background. The text "RIGHT LANE MUST TURN RIGHT" is written in bold black capital letters, arranged in four lines.</p>	<p>Right turn only sign (section 89)</p>  <p>A rectangular sign with a black border and a white background. It features a black arrow that curves from the bottom towards the top right. Below the arrow, the word "ONLY" is written in bold black capital letters.</p>
<p>Road access sign (sections 97, 229)</p>  <p>A rectangular sign with a black border and a white background. The text "NO PEDESTRIANS BICYCLES ANIMALS BEYOND THIS POINT" is written in bold black capital letters, arranged in six lines.</p>	<p>Roundabout sign (section 109)</p>  <p>An inverted triangular sign with a red border and a white background. In the center, there is a black circular arrow indicating a clockwise direction.</p>





Schedule 2

<p style="text-align: center;">Safety zone sign (sections 162, 190)</p> 	<p style="text-align: center;">Separated footpath sign (sections 239, 252)</p> 
<p style="text-align: center;">School zone sign (section 23)</p> 	<p style="text-align: center;">Shared path sign (sections 242, 252)</p> 
<p style="text-align: center;">Shared zone sign (section 24)</p> 	<p style="text-align: center;">Slow vehicle turn out lane sign (section 130)</p> 



<p>Speed derestriction sign (section 21)</p> 	<p>Speed limit sign (Standard sign) (sections 21, 316)</p> 
<p>Speed limit sign (Variable illuminated message sign) (sections 21, 316)</p> 	<p>Stop here on red arrow sign (section 56)</p> 
<p>Stop here on red signal sign (section 56)</p> 	<p>Stop sign (sections 67, 68, 121)</p> 

Schedule 2

<p>Taxi zone sign (section 182)</p> 	<p>Traffic light-stop sign (section 63)</p> 
<p>Tram lane sign (section 155)</p> 	<p>Transit lane sign (Transit lane (T2) sign) (section 156)</p> 
<p>Transit lane sign (Transit lane (T3) sign) (section 156)</p> 	<p>Truck lane sign (section 157)</p> 



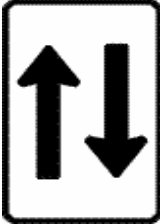



<p>Trucks and buses low gear sign (section 108)</p>  <p>A rectangular sign with a black border and black text on a white background. The text reads: TRUCKS & BUSES MUST USE LOW GEAR.</p>	<p>Trucks must enter sign (section 105)</p>  <p>A rectangular sign with a black border and black text on a white background. The text reads: TRUCKS MUST ENTER.</p>
<p>Trucks use left lane sign (section 159)</p>  <p>A rectangular sign with a black border and black text on a white background. The text reads: TRUCKS USE LEFT LANE.</p>	<p>Truck zone sign (section 180)</p>  <p>A rectangular sign with a red border and red text on a white background. The text reads: TRUCK ZONE. Below the text is a red arrow pointing to the left.</p>

Schedule 2







<p>Two-way sign (sections 98, 132, 136)</p> 	<p>U-turn permitted sign (section 40)</p> 
<p>Works zone sign (section 181)</p> 	







Schedule 3 Other permitted traffic signs

sections 314 and 316







<p>Area speed limit sign (section 22)</p> 	<p>Area speed limit sign (section 22)</p> 
<p>Area speed limit sign (section 22)</p> 	<p>Bicycle lane sign (sections 153, 252)</p> 
<p>Bicycle lane sign (sections 153, 252)</p> 	<p>Bicycle path sign (sections 239, 242, 252)</p> 







Schedule 3

<p style="text-align: center;">Bicycle path sign (sections 239, 242, 252)</p> 	<p style="text-align: center;">Bridge load limit (mass per axle group sign) (section 103)</p> 
<p style="text-align: center;">Bridge load limit (mass per axle group sign) (section 103)</p> 	<p style="text-align: center;">Buses must enter sign (section 107)</p> 
<p style="text-align: center;">Bus lane sign (section 154)</p> 	<p style="text-align: center;">Bus lane sign (section 154)</p> 









<p>Bus lane sign (section 154)</p> 	<p>Bus lane sign (section 154)</p> 
<p>Bus lane sign (section 154)</p> 	<p>Bus lane sign (section 154)</p> 
<p>Bus lane sign (section 154)</p> 	<p>Bus lane sign (section 154)</p> 







Schedule 3

<p style="text-align: center;">Bus lane sign (section 154)</p> <div style="text-align: center;">  </div>	<p style="text-align: center;">Bus zone sign (section 183)</p> <div style="text-align: center;">  </div>
<p style="text-align: center;">Bus zone sign (section 183)</p> <div style="text-align: center;">  </div>	<p style="text-align: center;">Children's crossing sign (section 80)</p> <div style="text-align: center;">  </div>
<p style="text-align: center;">End area speed limit sign (section 22)</p> <div style="text-align: center;">  </div>	<p style="text-align: center;">End area speed limit sign (section 22)</p> <div style="text-align: center;">  </div>



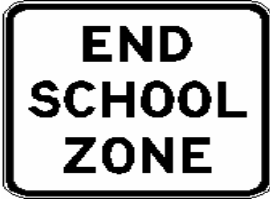

<p>End area speed limit sign (section 22)</p> 	<p>End bicycle lane sign (section 153)</p> 
<p>End bicycle path sign (section 239)</p> 	<p>End bicycle path sign (section 239)</p> 
<p>End bus lane sign (section 154)</p> 	<p>End bus lane sign (section 154)</p> 





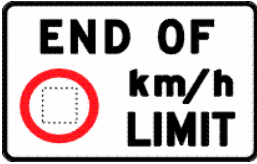



Schedule 3

<p>End bus lane sign (section 154)</p> 	<p>End bus lane sign (section 154)</p> 
<p>End freeway sign (sections 97, 177)</p> 	<p>End freeway sign (sections 97, 177)</p> 
<p>End freeway sign (sections 97, 177)</p> 	<p>End freeway sign (sections 97, 177)</p> 
<p>End keep left unless overtaking sign (section 130)</p> 	<p>End school zone sign (section 23)</p> 







<p>End school zone sign (section 23)</p> 	<p>End school zone sign (section 23)</p> 
<p>End school zone sign (section 23)</p> 	<p>End separated footpath sign (section 239)</p> 
<p>End shared path sign (section 242)</p> 	<p>End shared zone sign (section 24)</p> 



Schedule 3

<p>End shared zone sign (section 24)</p> 	<p>End speed limit sign (section 21)</p> 
<p>End tram lane sign (section 155)</p> 	<p>End tramway sign (section 155A)</p> 
<p>End transit lane sign (section 156)</p> 	<p>End trucks and buses low gear sign (section 108)</p> 

<p>End truck lane sign (section 157)</p> 	<p>Freeway sign (section 177)</p> 
<p>Freeway sign (section 177)</p> 	<p>Freeway sign (section 177)</p> 
<p>Freeway sign (section 177)</p> 	<p>Freeway sign (section 177)</p> 
<p>Hand-held stop sign (section 80)</p> 	<p>Hand-held stop sign (section 80)</p> 

Schedule 3

<p>Hand-held stop sign (section 80)</p> 	<p>Hand-held stop sign (section 80, 101)</p> 
<p>Keep right sign (sections 99, 135)</p> 	<p>Lane control ends sign (section 152)</p> 
<p>Left lane must turn left sign (section 88)</p> 	<p>Left turn only sign (section 88)</p> 

<p>Loading zone sign (section 179)</p> 	<p>Loading zone sign (section 179)</p> 
<p>Median turning lane sign (section 86)</p> 	<p>No bicycles sign (sections 239, 242, 252)</p> 
<p>No entry sign (section 100)</p> 	<p>No entry sign (section 100)</p> 

Schedule 3

<p>No entry sign (section 100)</p> 	<p>No entry sign (section 100)</p> 
<p>No left turn sign (Standard sign) (section 91)</p> 	<p>No left turn sign (Variable illuminated message sign) (section 91)</p> 
<p>No overtaking on bridge sign (section 94)</p> 	<p>No parking sign (for a length of road) (section 168)</p> 

<p>No parking sign (for a length of road) (section 168)</p> 	<p>No parking sign (for a length of road) (section 168)</p> 
<p>No parking sign (for a length of road) (section 168)</p> 	<p>No parking sign (for an area) (section 168)</p> 
<p>No parking sign (for an area) (section 168)</p> 	<p>No parking sign (for an area) (section 168)</p> 

Schedule 3

<p>No personal mobility devices sign (section 244H)</p> 	<p>No personal mobility devices sign (section 244H)</p> 
<p>No right turn sign (Standard sign) (section 91)</p> 	<p>No right turn sign (Variable illuminated message sign) (section 91)</p> 
<p>No right turn sign (section 91)</p> 	<p>No stopping sign (for a length of road) (section 167)</p> 

<p>No stopping sign (for a length of road) (section 167)</p> 	<p>No stopping sign (for a length of road) (section 167)</p> 
<p>No stopping sign (for an area) (section 167)</p> 	<p>No stopping sign (section 167)</p> 
<p>No U-turn sign (Standard sign) (section 39)</p> 	<p>No U-turn sign (Variable illuminated message sign) (section 39)</p> 





Schedule 3

<p>No wheeled recreational devices or toys sign (section 240A)</p> 	<p>No wheeled recreational devices or toys sign (section 240A)</p> 
<p>One-way sign (section 98)</p> 	<p>Pedestrians may cross diagonally sign (sections 230, 234)</p> 
<p>Permissive parking sign (for a length of road) (section 204)</p> 	<p>Permissive parking sign (for a length of road) (section 204)</p> 





<p>Permissive parking sign (for a length of road) (section 204)</p>  <p>A rectangular sign with a green border. The word "PARKING" is written in green capital letters in the center. A green arrow points to the right at the bottom of the sign.</p>	<p>Permissive parking sign (for a length of road) (section 204)</p>  <p>A rectangular sign with a green border. The words "METER PARKING" are written in green capital letters in the center. A green arrow points to the right at the bottom of the sign.</p>
<p>Permissive parking sign (for an area) (section 204)</p>  <p>A rectangular sign with a black border. At the top, the words "TRAFFIC AREA" are written in black capital letters. Below this, there is a dashed rectangular box on the left and a large green letter "P" on the right.</p>	<p>Permissive parking sign (for an area) (section 204)</p>  <p>A blue rectangular sign with rounded corners. The words "PAY PARKING" are written in white capital letters at the top.</p>
<p>Permissive parking sign (for an area) (section 204)</p>  <p>A blue rectangular sign with rounded corners. The words "PAY PARKING" are written in white capital letters at the top.</p>	<p>Permissive parking sign (for an area) (section 204)</p>  <p>A rectangular sign with a black border. At the top, there is a green letter "P" inside a green circle. Below this, the words "PARKING AREA" are written in black capital letters.</p>

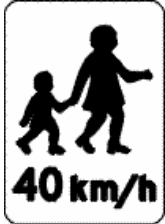
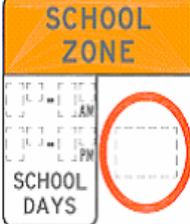



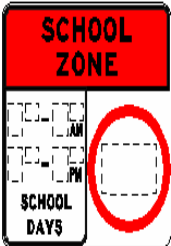

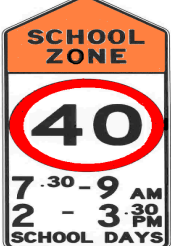
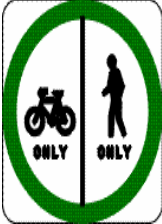
Schedule 3

<p>Permit zone sign (section 185)</p> 	<p>Permit zone sign (section 185)</p> 
<p>Right lane must turn right sign (section 89)</p> 	<p>Right turn only sign (section 89)</p> 
<p>Right turn only sign (section 89)</p> 	<p>Road access sign (sections 97, 229)</p> 







<p>School zone sign (section 23)</p> 	<p>School zone sign (section 23)</p> 
<p>School zone sign (section 23)</p> 	<p>School zone sign (section 23)</p> 
<p>School zone sign (section 23)</p> 	<p>School zone sign (section 23)</p> 







Schedule 3

<p style="text-align: center;">School zone sign (section 23)</p> 	<p style="text-align: center;">School zone sign (section 23)</p> 
<p style="text-align: center;">School zone sign (section 23)</p> 	<p style="text-align: center;">School zone sign (section 23)</p> 
<p style="text-align: center;">Separated footpath sign (sections 239, 252)</p> 	<p style="text-align: center;">Shared path sign (sections 242, 252)</p> 





<p style="text-align: center;">Shared zone sign (section 24)</p> 	<p style="text-align: center;">Shared zone sign (section 24)</p> 
<p style="text-align: center;">Stop here on red signal sign (section 56)</p> 	<p style="text-align: center;">Taxi zone sign (section 182)</p> 
<p style="text-align: center;">Taxi zone sign (section 182)</p> 	<p style="text-align: center;">Taxi zone sign (section 182)</p> 

Schedule 3

<p>Taxi zone sign (section 182)</p> 	<p>Tram lane sign (section 155)</p> 
<p>Tram lane sign (section 155)</p> 	<p>Tramway sign (section 155A)</p> 
<p>Transit lane sign (section 156)</p> 	<p>Transit lane sign (section 156)</p> 





<p style="text-align: center;">Truck arrester bed (section 101A)</p> 	<p style="text-align: center;">Truck arrester bed (section 101A)</p> 
<p style="text-align: center;">Trucks and buses low gear sign (section 108)</p> 	<p style="text-align: center;">Trucks and buses low gear sign (section 108)</p> 
<p style="text-align: center;">Trucks must enter sign (section 105)</p> 	<p style="text-align: center;">Trucks must enter sign (section 105)</p> 

Schedule 3





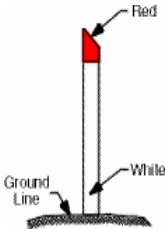
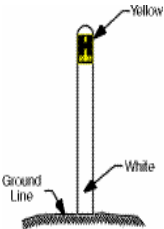
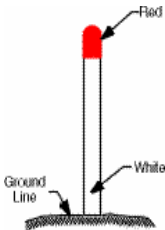

<p>Trucks use left lane sign (section 159)</p>  <p>A rectangular sign with a black border and black text on a white background. The text reads: "TRUCKS MUST USE LEFT LANE NEXT [] km".</p>	<p>Truck zone sign (section 180)</p>  <p>A rectangular sign with a black border and red text on a white background. The text reads: "TRUCK ZONE". Below the text is a red arrow pointing to the left.</p>
<p>Two-way sign (sections 98, 132, 136)</p>  <p>A rectangular sign with a black border and black text on a white background. It features two large black arrows, one pointing up and one pointing down, positioned above the text "TWO WAY".</p>	<p>Works zone sign (section 181)</p>  <p>A rectangular sign with a black border and red text on a white background. The text reads: "CONSTRUCTION ZONE". Below the text is a red arrow pointing to the left.</p>



Schedule 4 Symbols and traffic-related items

sections 314, 316 and 320

<p>Do not overtake turning vehicle sign (sections 28, 32, 143)</p> 	<p>Do not overtake turning vehicle sign (sections 28, 32, 143)</p> 
<p>Fire hydrant indicator (example) (section 194)</p> 	<p>Fire hydrant indicator (example) (section 194)</p> 
<p>Fire plug indicator (example) (section 194)</p> 	<p>Give way to buses sign (section 77)</p> 

Schedule 4

<p>Green bicycle symbol (section 260)</p>  A green silhouette of a bicycle centered within a black circle, which is itself centered within a white square.	<p>Green pedestrian symbol (section 231)</p>  A green silhouette of a person walking, centered within a black circle, which is itself centered within a white square.
<p>People with disabilities symbol (section 203)</p>  A white silhouette of a person in a wheelchair, centered within a blue square.	<p>People with disabilities symbol (section 203)</p>  A blue silhouette of a person in a wheelchair, centered within a white square.
<p>Red bicycle symbol (section 260)</p>  A red silhouette of a bicycle centered within a black circle, which is itself centered within a white square.	<p>Red pedestrian symbol (section 231)</p>  A red silhouette of a person standing, centered within a black circle, which is itself centered within a white square.

<p>White B light (section 285)</p> 	<p>White T light (section 278)</p> 
<p>Yellow bicycle symbol (section 261)</p> 	

Schedule 5 Dictionary

section 4

angle parking see section 210.

approved bicycle helmet means a helmet that complies with—

- (a) AS 2063; or
- (b) AS/NZS 2063; or
- (c) another standard the chief executive considers is at least equal to a standard mentioned in paragraph (a) or (b).

approved seatbelt means a seatbelt complying with the vehicle standards for seatbelts under the Standards and Safety Regulation.

area includes—

- (a) a bridge; and
- (b) a network of roads; and
- (c) a slip lane.

AS/NZS means a standard published jointly by Standards Australia and Standards New Zealand.

bailiff means a bailiff appointed under the *Supreme Court of Queensland Act 1991*, the *District Court of Queensland Act 1967* or the *Magistrates Courts Act 1921*.

bicycle crossing means an area of a road—

- (a) at a place with bicycle crossing lights that would face the rider of a bicycle crossing the road and traffic lights that would face a vehicle driving on the road; and
- (b) indicated by a different road surface, or between 2 parallel continuous or broken lines, or rows of pavement markers, on the road surface substantially from 1 side of the road to the other.

Example of a different road surface—

The area of road could be indicated by brick paving across a road.

bicycle crossing light means a green, yellow or red bicycle crossing light.

bicycle crossing lights means a device designed to show a bicycle crossing light, or 2 or more bicycle crossing lights at different times.

bicycle lane see section 153.

bicycle path see section 239.

bicycle path road marking see section 239.

bicycle storage area means—

- (a) an area of a road before an intersection with traffic lights—
 - (i) that has painted on it 1 or more bicycle symbols; and
 - (ii) that is between 2 parallel stop lines, regardless of whether the lines are of equal length; but
- (b) does not include any stop line.

bicycle symbol means a symbol consisting of a picture of a bicycle.

bicycle trailer see section 257(2).

B light means a red, white or yellow B light.

B lights means a device designed to show a B light, or 2 or more B lights at different times.

built-up area, in relation to a length of road, means an area in which either of the following is present for a distance of at least 500m or, if the length of road is shorter than 500m, for the whole road—

- (a) buildings, not over 100m apart, on land next to the road;
- (b) street lights not over 100m apart.

bus means a motor vehicle built mainly to carry people that seats over 12 adults (including the driver).

bus lane see section 154.

bus zone see section 183.

centre of the road, for a driver on a two-way road, means the far right side of the part of the road used by traffic travelling in the same direction as the driver.

changes direction see section 45.

children's crossing see section 80.

continuing road, for a T-intersection, means the road (except a road-related area) that meets the terminating road at the T-intersection.

crash includes—

- (a) a collision between 2 or more vehicles; or
- (b) another accident or incident involving a vehicle in which a person is killed or injured, property is damaged, or an animal in someone's charge is killed or injured.

crossing means—

- (a) a bicycle crossing; or
- (b) a children's crossing; or
- (c) a level crossing; or
- (d) a marked foot crossing; or
- (e) a pedestrian crossing.

deputy sheriff means a deputy sheriff appointed under the *Supreme Court of Queensland Act 1991*, section 73.

detained person means a person who is in the custody or care of a relevant detention officer.

detention vehicle means a vehicle being used to transport a detained person.

dividing line means a road marking formed by a line, or 2 parallel lines, whether broken or continuous, designed to indicate the parts of the road to be used by vehicles travelling in opposite directions.

dividing strip means an area or structure that divides a road lengthways, but does not include a nature strip, bicycle path, footpath or shared path.

do not overtake turning vehicle sign means a sign shown in a diagram in schedule 4 as a Do not overtake turning vehicle sign.

drive includes be in control of.

driver see sections 16 and 19.

driver's vehicle for a driver, means the vehicle being driven by the driver.

edge line, for a road, means a line marked along the road at or near the far left or far right side of the road (except any road-related area of the road).

emergency stopping lane see section 95.

emergency vehicle means a motor vehicle driven by a person who is—

- (a) an emergency worker; and
- (b) driving the vehicle in the course of performing duties as an emergency worker.

emergency worker means—

- (a) an officer of the Queensland Ambulance Service or an ambulance service of another State; or
- (b) a fire officer under the *Fire and Emergency Services Act 1990* or a fire and rescue service of another State; or
- (c) an officer or employee of another entity with the written permission of the commissioner.

end bicycle path road marking see section 239.

end separated footpath road marking see section 239.

enter, an intersection or crossing, for the driver of a vehicle or a train, means enter the intersection or crossing with any part of the vehicle or train.

freeway see section 177.

front fog light see section 217.

give way, for a driver or pedestrian, means—

- (a) if the driver or pedestrian is stopped—remain stationary until it is safe to proceed; or
- (b) in any other case—slow down and, if necessary, stop to avoid a collision.

give way line means a broken line that is marked across all or part of a road and is not part of a bicycle crossing or marked foot crossing.

green bicycle crossing light means an illuminated green bicycle symbol as shown in the diagram in schedule 4.

green pedestrian light means—

- (a) an illuminated green pedestrian symbol; or
- (b) the word ‘walk’ illuminated in green (whether or not flashing).

green pedestrian symbol means a symbol consisting of a picture of a pedestrian as shown in the diagram in green in schedule 4.

green traffic arrow means an illuminated green arrow.

green traffic light means an illuminated green disc.

halfway around, for a roundabout, see section 110.

hazard warning lights means a pair of yellow direction indicator lights that—

- (a) are fitted to a vehicle under—
 - (i) the heavy vehicle standards under the Heavy Vehicle National Law (Queensland); or
 - (ii) the Standards and Safety Regulation; and
- (b) display regular flashes of light at the same time, and at the same rate, as each other.

high-beam, for a headlight fitted to a vehicle, means that the headlight is built or adjusted so, when the vehicle is standing

on level ground, the top of the main beam of light projected is above the headlight's low-beam.

hook turn see sections 34 and 35.

intersection means the area where 2 or more roads (except any road-related area) meet, and includes—

- (a) any area of the roads where vehicles travelling on different roads might collide; and
- (b) the place, other than a road-related area, where a slip lane between the roads meets the road into which traffic on the slip lane may turn.

land includes premises or a part of premises.

left change of direction signal means a change of direction signal given in accordance with section 47.

left traffic lane arrows means traffic lane arrows applying to a marked lane that indicate only a direction to the left.

length of road includes—

- (a) a marked lane or a part of a marked lane; and
- (b) another part of a length of road.

level crossing see section 120.

line of traffic means—

- (a) 2 or more vehicles, other than vehicles in a marked lane, travelling in line on a road, whether or not the vehicles are moving; or
- (b) a single vehicle, other than a vehicle in a marked lane or a vehicle that is part of a line of traffic under paragraph (a), that is travelling along a road, whether or not the vehicle is moving.

Examples—

- 1 A vehicle travelling on a road, other than in a marked lane, in line behind another vehicle forms part of a line of traffic with the other vehicle.
- 2 A vehicle travelling on a road, other than in a marked lane, with no other vehicles near it forms a line of traffic by itself.

Schedule 5

- 3 Two vehicles travelling in the same direction on a road, other than in a marked lane, but not in line, form 2 lines of traffic.

low-beam, for a headlight fitted to a vehicle, means that the headlight is built or adjusted so, when the vehicle is standing on level ground, the top of the main beam of light projected is—

- (a) not higher than the centre of the headlight, when measured 8m in front of the vehicle; and
- (b) not over 1m higher than the level where the vehicle is standing, when measured 25m in front of the vehicle.

mail zone see section 186.

marked foot crossing means an area of a road—

- (a) at a place with pedestrian lights facing pedestrians crossing the road and traffic lights that would face vehicles driving on the road; and
- (b) indicated by a different road surface, or between 2 parallel continuous or broken lines, or rows of pavement markers, on the road surface substantially from 1 side of the road to the other.

Example of a different road surface—

The area of road could be indicated by brick paving across a bitumen road.

marked lane means an area of a road marked by continuous or broken lines, or rows of pavement markers, on the road surface that is designed for use by a single line of vehicles.

mechanical signalling device means a mechanical signalling device complying with the requirements for a mechanical signalling device under—

- (a) the heavy vehicle standards under the Heavy Vehicle National Law (Queensland); or
- (b) the Standards and Safety Regulation.

median strip means a dividing strip designed or developed to separate vehicles travelling in opposite directions.

median strip parking area means a parking area on, or in, a median strip.

multi-lane road, for a driver, means a one-way road, or a two-way road, with 2 or more marked lanes (except bicycle lanes) that are—

- (a) on the side of the dividing line or median strip where the driver is driving; and
- (b) for the use of vehicles travelling in the same direction.

nature strip, except in section 13(1), means an area between a road (except a road-related area) and adjacent land, but does not include a bicycle path, footpath or shared path.

night means the period between sunset on a day and sunrise on the next day.

no bicycles road marking means a road marking consisting of a bicycle symbol with a diagonal line across it, or the words ‘no bicycles’, or both the symbol and the words.

obstruction includes a traffic hazard, but does not include a vehicle only because the vehicle is stopped in traffic or is travelling more slowly than other vehicles.

oncoming vehicle, for a driver, means a vehicle approaching the driver travelling in the opposite direction to the direction in which the driver is driving.

one-way road means a road with 1 or more marked lanes, all of which are for the use of vehicles travelling in the same direction.

overhead lane control device means an overhead lane control sign or signal.

overhead lane control sign means a traffic sign displaying a red diagonal cross that is installed on a structure over a road or part of a road.

overhead lane control signal means—

- (a) an illuminated red diagonal cross (whether or not flashing); or
- (b) an illuminated white, green or yellow arrow pointing downwards or indicating 1 or more directions; or
- (c) a speed limit sign (variable illuminated message sign).

overhead lane control signals means a device on a structure over a road, or part of a road, that is designed to display an overhead lane control signal, or 2 or more overhead lane control signals.

oversize warning sign means a sign that—

- (a) displays the word ‘oversize’ in black, upper-case and non-reflective letters that—
 - (i) are at least 200mm high and at least 125mm from the top and bottom of the sign; and
 - (ii) are in typeface series C(N); and
 - (iii) comply with AS 1744 Forms of letters and numerals (known as standard alphabets for road signs); and
- (b) is at least 450mm high and at least 1200mm long, whether or not it is split; and
- (c) for a split sign—does not have a border between the 2 parts of the sign; and
- (d) except for the part of its surface required to be made of retroreflective material, is made of rigid, flat and weatherproof material unless, for a sign attached to the rear of a vehicle, the vehicle’s load makes it impractical to have a rigid warning sign; and
- (e) is clean enough to be easily read by other road users.

overtake, for a driver, means the action of—

- (a) approaching from behind another driver travelling in the same marked lane or line of traffic; and
- (b) moving into an adjacent marked lane or a part of a road where there is room for a line of traffic, whether or not the lane or part of the road is for drivers travelling in the same direction; and
- (c) passing the other driver while travelling in the adjacent marked lane or line of traffic.

painted island means an area of a road that—

- (a) has painted on it stripes or chevrons in white or another colour that contrasts with the colour of the road; and
- (b) is surrounded either—
 - (i) by a line or lines (whether broken or continuous); or
 - (ii) partly by a combination of a line or lines (whether broken or continuous) and partly by a kerb or by a structure on or next to the road.

parking area means a length of road or area designed for parking vehicles.

parking control sign means any of the following—

- (a) a bicycle parking sign;
- (b) a bus zone sign;
- (c) a clearway sign;
- (d) a loading zone sign;
- (e) a mail zone sign;
- (g) a motorbike parking sign;
- (h) a no parking sign;
- (i) a no stopping sign;
- (j) a people with disabilities parking sign;
- (k) a permissive parking sign;
- (l) a permit zone sign;
- (m) a taxi zone sign;
- (n) a truck zone sign;
- (o) a works zone sign.

part of the road used by the main body of moving vehicles means the area of the road, except—

- (a) a road-related area; and

- (b) if the road has 1 or more service roads—the area of a service road.

passenger transport standard means the *Transport Operations (Passenger Transport) Standard 2010*.

pavement marker means a raised marker or stud attached to the road to—

- (a) augment the visibility of a painted road marking or painted island; or
- (b) mark a marked lane, bicycle crossing or marked foot crossing, whether or not a painted road marking is also used.

pedestrian see section 18.

pedestrian crossing see section 81.

pedestrian lights means a device designed to show, at different times, a green or red pedestrian light.

pedestrian symbol means a symbol consisting of a picture of a pedestrian.

people with disabilities road marking see section 203.

people with disabilities symbol means a picture of a person seated in a wheelchair as shown in the diagrams in schedule 4.

permit zone see section 185.

PMD user see section 244C.

police vehicle means a vehicle driven by a police officer of the Queensland Police Service, or the police service of the Commonwealth or another State, in the course of the police officer's duty.

portable warning triangle means a device that complies with AS 3790–1992.

postal vehicle means a vehicle driven by a person who is—

- (a) a postal worker; and
- (b) driving the vehicle in the course of performing duties as a postal worker.

postal worker means a person who delivers letter mail and parcels within Australia as an employee or contractor of Australia Post.

red bicycle crossing light means an illuminated red bicycle symbol (whether or not flashing) as shown in the diagram in schedule 4.

red B light means an illuminated red B.

red pedestrian light means—

- (a) an illuminated red pedestrian symbol (whether or not flashing); or
- (b) the words ‘don’t walk’ illuminated in red (whether or not flashing).

red pedestrian symbol means a symbol consisting of a picture of a pedestrian as shown in the diagram in red in schedule 4.

red T light means an illuminated red T.

red traffic arrow means an illuminated red arrow.

red traffic light means an illuminated red disc.

relevant detention officer means any of the following—

- (a) a corrective services officer under the *Corrective Services Act 2006*;
- (b) the sheriff or a deputy sheriff;
- (c) a bailiff;
- (d) a staff member under the *Police Service Administration Act 1990* who, in the course of the staff member’s duties, transports detained persons.

ride, for the rider of a motorbike or animal-drawn vehicle, includes be in control of.

rider see section 17.

right change of direction signal means a change of direction signal given in accordance with section 49.

right traffic lane arrows means traffic lane arrows applying to a marked lane that indicate only a direction to the right.

road see section 11.

Note—

See also the definition *road* in schedule 4 of the Act.

road marking means a word, figure, symbol, mark, line, pavement marker, or something else, on the surface of a road to direct or warn traffic, but does not include a painted island.

road-related area see section 13.

road user see section 14.

roundabout see section 109.

safety zone see section 162.

school bus see the passenger transport standard, schedule 4.

school zone see section 23.

separated footpath see section 239.

separated footpath road marking see section 239.

service road means the part of a road that—

- (a) is separated from other parts of the road by a dividing strip that is not designed or developed, wholly or mainly, to separate vehicles travelling in opposite directions; and
- (b) is—
 - (i) designed or developed to be used, wholly or mainly, by traffic servicing adjacent land; or
 - (ii) indicated to be a service road by information on or with a traffic control device on the road.

shared path see section 242.

shared zone see section 24.

sheriff means the Sheriff of Queensland appointed under the *Supreme Court of Queensland Act 1991*, section 73.

shoulder see section 13.

slip lane means an area of road for vehicles turning left that is separated, at some point, from other parts of the road by a painted island or traffic island, but not by a median strip.

special purpose lane means a marked lane, or the part of a marked lane, that is a bicycle lane, bus lane, emergency stopping lane, tram lane, transit lane or truck lane.

speed limited area see section 22.

Standards and Safety Regulation means the *Transport Operations (Road Use Management—Vehicle Standards and Safety) Regulation 2010*.

stop, in part 12 and for a driver, includes park, but does not include stop to reverse the driver's vehicle into a parking bay or other parking space.

stop line means a continuous line that—

- (a) is marked across all or part of a road; and
- (b) is not part of a bicycle crossing, a marked foot crossing, a keep clear marking or a bicycle storage area for hook turns.

straight ahead includes substantially straight ahead.

taxi means—

- (a) for section 182—a taxi under the *Transport Operations (Passenger Transport) Act 1994*; or
- (b) otherwise—a taxi or limousine under that Act.

taxi zone see section 182.

terminating road, for a T-intersection, means—

- (a) if a road (except a road-related area) at the intersection is designated by traffic signs or road markings, or in another way, as a road that ends at the intersection—that road; or
- (b) in any other case—a road (except a road-related area) that ends at the intersection.

T-intersection means an intersection, other than a roundabout, where 2 roads meet (whether or not at right angles) and 1 of the roads ends.

T light means a red, white or yellow T light.

T lights means a device designed to show a T light, or 2 or more T lights at different times.

traffic includes vehicles and pedestrians.

traffic arrow means a green, white or red traffic arrow, or a yellow traffic arrow (whether or not flashing).

traffic arrows means a device designed to show a traffic arrow, or 2 or more traffic arrows at different times.

traffic control device means a traffic sign, road marking, traffic signals, or other device, to direct or warn traffic on, entering or leaving a road.

traffic island means a structure on a road to direct traffic, but does not include a road marking or painted island.

traffic lane arrows means a traffic sign, road marking or device that displays arrows indicating 1 or more directions and is designed to apply to 1 or more marked lanes, but does not include traffic arrows.

traffic light means a green traffic light, or a red or yellow traffic light (whether or not flashing).

traffic lights means a device designed to show a traffic light, or 2 or more traffic lights in a vertical arrangement and at different times, and includes any traffic arrows installed with or near the device.

traffic lights pole means a pole or other structure on which traffic lights are installed.

traffic-related item means any of the following—

- (a) a do not overtake turning vehicle sign;
- (b) a give way to buses sign;
- (c) a fire hydrant indicator or fire plug indicator.

traffic sign means a board, plate, screen, or another device, whether or not illuminated, displaying words, figures, symbols or anything else to direct or warn traffic on, entering or leaving a road, and includes a children crossing flag, a hand-held stop sign, a parking control sign and a variable illuminated message sign, but does not include traffic signals.

traffic signals means bicycle crossing lights, B lights, overhead lane control signals, pedestrian lights, T lights, traffic arrows, traffic lights or twin red or yellow lights.

tram lane see section 155.

tram recovery vehicle means a vehicle used by a tram operator to access and recover disabled trams for which the tram operator is responsible.

tram stop means a place on a road at which there is a sign indicating that trams will stop to enable people to get on or off.

tram tracks includes a rail designed for a light rail vehicle to run on.

tramway see section 155A.

transit lane see section 156.

travelling along tram tracks, for a bus, means being driven along the area where the tram tracks are laid.

truck lane see section 157.

truck zone see section 180.

turning lane means a marked lane, or the part of a marked lane, for vehicles travelling in 1 direction to which—

- (a) a left turn only sign, a left lane must turn left sign or left traffic lane arrows apply; or
- (b) a right turn only sign, a right lane must turn right sign or right traffic lane arrows apply; or
- (c) a U-turn permitted sign or U-turn traffic lane arrows apply.

turn line means a road marking, at an intersection, consisting of a line (whether broken or continuous) that is designed to indicate how a turn is to be made at the intersection.

twin red lights means a device showing, in a horizontal or diagonal arrangement, 2 illuminated red discs that flash alternately.

twin yellow lights means a device showing, in a horizontal or diagonal arrangement, 2 illuminated yellow discs that flash alternately.

two-way road means a road for use by vehicles travelling in opposite directions.

U-turn means a turn made by a driver so that the driver's vehicle faces in approximately the opposite direction from which it was facing immediately before the turn was made, but does not include a turn made at a roundabout.

U-turn traffic lane arrows means traffic lane arrows applying to a marked lane that indicate only a U-turn direction.

variable illuminated message device means a device designed to display, and to change or turn off from time to time by electronic or optical means, illuminated words, figures, symbols, or anything else, to direct or warn traffic on, entering or leaving a road, but does not include traffic signals.

variable illuminated message sign means the illuminated words, figures, symbols, or other things, displayed at any relevant time on a variable illuminated message device.

vehicle see section 15.

white B light means an illuminated white B as shown in the diagram in schedule 4.

white T light means an illuminated white T as shown in the diagram in schedule 4.

white traffic arrow means an illuminated white arrow.

window, in relation to a vehicle, includes any sunroof fitted to the vehicle.

with, for information about the application of a traffic control device, includes accompanying or reasonably associated with the device.

yellow bicycle crossing light means an illuminated yellow bicycle symbol (whether or not flashing) as shown in the diagram in schedule 4.

yellow B light means an illuminated yellow B.

yellow T light means an illuminated yellow T.

yellow traffic arrow means an illuminated yellow arrow.

yellow traffic light means an illuminated yellow disc.

Endnotes

1 Index to endnotes

	Page
2 Key	410
3 Table of reprints	411
4 List of legislation	412
5 List of annotations	414

2 Key

Key to abbreviations in list of legislation and annotations

Key	Explanation	Key	Explanation
AIA	= Acts Interpretation Act 1954	(prev)	= previously
amd	= amended	proc	= proclamation
amdt	= amendment	prov	= provision
ch	= chapter	pt	= part
def	= definition	pubd	= published
div	= division	R[X]	= Reprint No. [X]
exp	= expires/expired	RA	= Reprints Act 1992
gaz	= gazette	reloc	= relocated
hdg	= heading	renum	= renumbered
ins	= inserted	rep	= repealed
lap	= lapsed	(retro)	= retrospectively
notfd	= notified	rv	= revised version
num	= numbered	s	= section
o in c	= order in council	sch	= schedule
om	= omitted	sdiv	= subdivision
orig	= original	SIA	= Statutory Instruments Act 1992
p	= page	SIR	= Statutory Instruments Regulation 2012
para	= paragraph	SL	= subordinate legislation
prec	= preceding	sub	= substituted
pres	= present	unnum	= unnumbered
prev	= previous		

3 Table of reprints

A new reprint of the legislation is prepared by the Office of the Queensland Parliamentary Counsel each time a change to the legislation takes effect.

The notes column for this reprint gives details of any discretionary editorial powers under the *Reprints Act 1992* used by the Office of the Queensland Parliamentary Counsel in preparing it. Section 5(c) and (d) of the Act are not mentioned as they contain mandatory requirements that all amendments be included and all necessary consequential amendments be incorporated, whether of punctuation, numbering or another kind. Further details of the use of any discretionary editorial power noted in the table can be obtained by contacting the Office of the Queensland Parliamentary Counsel by telephone on 3003 9601 or email legislation.queries@oqpc.qld.gov.au.

From 29 January 2013, all Queensland reprints are dated and authorised by the Parliamentary Counsel. The previous numbering system and distinctions between printed and electronic reprints is not continued with the relevant details for historical reprints included in this table.

Reprint No.	Amendments included	Effective	Notes
1	none	12 October 2009	
1A	none	11 March 2010	certain provs commenced
1B	2010 SL No. 65	16 April 2010	
1C	2010 SL No. 191	1 September 2010	
1D	2010 SL No. 295	22 October 2010	
1E	2011 SL No. 3	28 January 2011	
1F	2011 SL No. 3 2011 SL No. 8	31 March 2011	R1F withdrawn, see R2
2	—	31 March 2011	
2A	2011 SL No. 212	28 October 2011	
2B	2011 SL No. 287	9 December 2011	
2C	2012 SL No. 215	30 November 2012	
2D	2012 SL No. 250	21 December 2012	

Current as at	Amendments included	Notes
5 April 2013	2013 SL No. 42	
26 July 2013	2013 SL No. 150	
1 August 2013 rv	2013 SL No. 150	
4 October 2013	2013 SL No. 192	
10 February 2014	2014 SL No. 8	
7 April 2014	2014 SL No. 26	
21 May 2014	2014 Act No. 17	
25 July 2014	2014 SL No. 161	RA s 44A
1 October 2014	2014 SL No. 219	
1 January 2015	2014 SL No. 219 2014 SL No. 279	RA s 44

4 List of legislation

Regulatory impact statements

For subordinate legislation that has a regulatory impact statement, specific reference to the statement is included in this list.

Explanatory notes

All subordinate legislation made on or after 1 January 2011 has an explanatory note. For subordinate legislation made before 1 January 2011 that has an explanatory note, specific reference to the note is included in this list.

Transport Operations (Road Use Management—Road Rules) Regulation 2009 SL No. 194 (may also be cited as Queensland Road Rules)

made by the Governor in Council on 10 September 2009

notfd gaz 11 September 2009 pp 148–9

ss 1–2 commenced on date of notification

ss 266, 267(1), (1AA), (1AB), (1A), (1B), (1C) commenced 11 March 2010 (see s 2(2))

remaining provisions commenced 12 October 2009 (see s 2(1))

exp 1 September 2020 (see SIA s 54)

Note—The expiry date may have changed since this reprint was published. See the latest reprint of the SIR for any change.

amending legislation—

Transport Operations (Road Use Management—Road Rules) Amendment Regulation (No. 1) 2010 SL No. 65

notfd gaz 16 April 2010 pp 952–3

commenced on date of notification

Transport Operations (Road Use Management—Vehicle Registration) Regulation 2010 SL No. 191 ss 1–2, 133 sch 7

notfd gaz 23 July 2010 pp 1196–9

ss 1–2 commenced on date of notification

remaining provisions commenced 1 September 2010 (see s 2)

Transport Legislation Amendment Regulation (No. 3) 2010 SL No. 295 pts 1, 3

notfd gaz 22 October 2010 pp 475–6

commenced on date of notification

Transport and Other Legislation Amendment Regulation (No. 1) 2011 SL No. 3 pts 1, 3

notfd gaz 28 January 2011 pp 156–7

s 6 commenced 31 March 2011 (see s 2)

remaining provisions commenced on date of notification

Transport Legislation Amendment Regulation (No. 1) 2011 SL No. 8 pts 1, 5

notfd gaz 25 February 2011 pp 327–8

ss 1–2 commenced on date of notification

remaining provisions commenced 31 March 2011 (see s 2)

- Transport Legislation Amendment Regulation (No. 4) 2011 SL No. 212 pts 1, 3**
 notfd gaz 28 October 2011 pp 398–9
 commenced on date of notification
- Transport Legislation Amendment Regulation (No. 6) 2011 SL No. 287 pts 1, 3**
 notfd gaz 9 December 2011 pp 729–35
 commenced on date of notification
- Transport and Other Legislation Amendment Regulation (No. 1) 2012 SL No. 215 pts 1, 4**
 notfd gaz 30 November 2012 pp 444–6
 commenced on date of notification
- Transport Legislation Amendment Regulation (No. 3) 2012 SL No. 250 pts 1, 5**
 notfd gaz 21 December 2012 pp 599–602
 ss 1–2 commenced on date of notification
 remaining provisions commenced 21 December 2012 (see s 2)
- Transport Legislation Amendment Regulation (No. 1) 2013 SL No. 42 s 1, pt 3**
 notfd gaz 5 April 2013 pp 490–1
 commenced on date of notification
- Transport and Other Legislation Amendment Regulation (No. 1) 2013 SL No. 150 ss 1–2(1), pt 4**
 notfd gaz 26 July 2013 pp 912–13
 ss 1–2 commenced on date of notification
 ss 10–14, 16–18, 23–27 commenced 1 August 2013 (see s 2(1))
 remaining provisions commenced on date of notification
- Transport and Other Legislation Amendment Regulation (No. 2) 2013 SL No. 192 pts 1, 4**
 notfd <www.legislation.qld.gov.au> 4 October 2013
 commenced on date of notification
- Transport and Other Legislation Amendment Regulation (No. 1) 2014 SL No. 8 pts 1, 12**
 notfd <www.legislation.qld.gov.au> 3 February 2014
 ss 1–2 commenced on date of notification
 remaining provisions commenced 10 February 2014 on the commencement of the
 Transport and Other Legislation (Heavy Vehicle National Law) Amendment Act
 2013, part 4 (see s 2)
- Transport Legislation and Another Regulation Amendment Regulation (No. 1) 2014 SL No. 26 pts 1, 3**
 notfd <www.legislation.qld.gov.au> 21 March 2014
 ss 1–2 commenced on date of notification
 remaining provisions commenced 7 April 2014 (see s 2)

Endnotes

Public Safety Business Agency Act 2014 No. 17 ss 1, 184 sch 1 pt 2

date of assent 21 May 2014
commenced on date of assent

Transport and Other Legislation Amendment Regulation (No. 2) 2014 SL No. 161 pts 1, 11

notfd <www.legislation.qld.gov.au> 25 July 2014
commenced on date of notification

Transport Legislation and Another Regulation Amendment Regulation (No. 2) 2014 SL No. 219 pts 1, 11

notfd <www.legislation.qld.gov.au> 26 September 2014
ss 1–2 commenced on date of notification
s 54 commenced 1 January 2015 (see s 2(2)(g))
remaining provisions commenced 1 October 2014 (see s 2(1))

Transport and Other Legislation Amendment Regulation (No. 3) 2014 SL No. 279 pts 1, 4

notfd <www.legislation.qld.gov.au> 28 November 2014
ss 1–2 commenced on date of notification
remaining provisions commenced 1 January 2015 (see s 2)

Transport and Other Legislation Amendment Regulation (No. 4) 2014 SL No. 325 pts 1–2

notfd <www.legislation.qld.gov.au> 19 December 2014
ss 1–2 commenced on date of notification
remaining provisions commence 1 February 2015 (see 2)

5 List of annotations

Compliance with standards

s 5 sub 2013 SL No. 192 s 7

What is a *vehicle*

s 15 amd 2013 SL No. 150 s 10

Personal mobility devices

s 15A ins 2014 SL No. 219 s 53

Pedestrian includes personal mobility device user

s 18 sub 2013 SL No. 150 s 11

Speed limit in a shared zone

s 24 amd 2013 SL No. 192 s 8

Speed limit for certain vehicles

s 24A amd 2014 SL No. 8 s 65

Stopping on a red traffic light or arrow

s 56 amd 2013 SL No. 192 s 9

Proceeding through a red traffic light

s 59 amd 2013 SL No. 192 s 10

Giving way when turning at intersection with traffic lights

s 62 amd 2013 SL No. 192 s 11

Giving way at a flashing yellow traffic arrow at an intersection

s 64 amd 2013 SL No. 192 s 12

Giving way at a marked foot crossing (except at an intersection) with a flashing yellow traffic light

s 65 amd 2013 SL No. 192 s 13

Stopping and giving way at a stop sign or stop line at an intersection without traffic lights

s 67 amd 2013 SL No. 192 s 14

Giving way at a give way sign or give way line at an intersection, other than a roundabout

s 69 amd 2013 SL No. 192 s 14

Giving way at a give way sign at a bridge or length of narrow road

s 70 amd 2014 SL No. 279 s 8

Giving way at an intersection (except a T-intersection or roundabout)

s 72 amd 2013 SL No. 192 s 14

Giving way at a T-intersection

s 73 amd 2013 SL No. 192 s 14

Stopping at a children's crossing

s 80 amd 2014 SL No. 279 s 9

Giving way at a pedestrian crossing

s 81 amd 2014 SL No. 279 s 10

Overtaking or passing a vehicle at a children's crossing or pedestrian crossing

s 82 amd 2014 SL No. 279 s 11

Clearance and low clearance signs

s 102 amd 2011 SL No. 3 s 6

Entering a roundabout from a multi-lane road or a road with 2 or more lines of traffic travelling in the same direction

s 111 amd 2014 SL No. 279 s 12

Giving a left change of direction signal when entering a roundabout

s 112 amd 2013 SL No. 192 s 15

Giving a right change of direction signal when entering a roundabout

s 113 amd 2013 SL No. 192 s 16

What is a *level crossing*

s 120 amd 2014 SL No. 279 s 13

Endnotes

Keeping a minimum distance between long vehicles

s 127 amd 2014 SL No. 8 s 66

Entering particular blocked crossings

prov hdg amd 2013 SL No. 192 s 17(1)

s 128A amd 2013 SL No. 192 s 17(2)

Keeping to the far left side of a road

s 129 amd 2014 SL No. 279 s 14

Keeping to the left of the centre of a road or the dividing line

s 132 amd 2013 SL No. 192 s 18; 2014 SL No. 26 s 6

Exceptions to keeping to the left of a dividing line

s 134 amd 2013 SL No. 192 s 19; 2014 SL No. 279 s 15

Keeping off a dividing strip

s 137 amd 2013 SL No. 192 s 20; 2014 SL No. 26 s 7; 2014 SL No. 161 s 70

Keeping off a painted island

s 138 amd 2014 SL No. 26 s 7; 2014 SL No. 279 s 16

Exceptions for passing bicycle rider

s 139A ins 2014 SL No. 26 s 8

Passing or overtaking a vehicle displaying a do not overtake turning vehicle sign

s 143 amd 2013 SL No. 192 s 21

Keeping a safe distance when overtaking

s 144 amd 2014 SL No. 26 s 9

Keeping a safe lateral distance when passing bicycle rider

s 144A ins 2014 SL No. 26 s 10
 amd 2014 SL No. 279 s 17

Driving within a single marked lane or line of traffic

s 146 amd 2014 SL No. 26 s 11

Moving from 1 marked lane to another marked lane across a continuous line separating the lanes

s 147 amd 2014 SL No. 26 s 12; 2014 SL No. 279 s 18

Complying with overhead lane control devices

s 152 amd 2011 SL No. 3 s 7

Bicycle lanes

s 153 amd 2014 SL No. 279 s 19

Marked lanes required to be used by particular kinds of vehicles

s 159 amd 2013 SL No. 192 s 22

Driving past the rear of a stopped tram at a tram stop

s 163 amd 2013 SL No. 192 s 23

Stopping beside a stopped tram at a tram stop

s 164 amd 2013 SL No. 192 s 24

Staying stopped if a tram comes from behind a stopped driver and stops

s 164AA ins 2013 SL No. 192 s 25

Stopping on or near a children's crossing

s 171 amd 2013 SL No. 192 s 26

Stopping on or near a bicycle crossing (except at an intersection)

prov hdg sub 2013 SL No. 192 s 27(1)

s 174 amd 2013 SL No. 192 s 27(2)

Stopping in a loading zone

s 179 amd 2013 SL No. 192 s 28

Double parking

s 189 amd 2013 SL No. 192 s 29

Stopping on a path, dividing strip, nature strip, painted island or traffic island

s 197 amd 2014 SL No. 279 s 20

Stopping on roads—heavy and long vehicles

s 200 amd 2014 SL No. 8 s 67

Time extension for people with disabilities

s 206 amd 2011 SL No. 8 s 20

Using lights when driving at night or in hazardous weather conditions

s 215 amd 2014 SL No. 8 s 68

Towing a vehicle at night or in hazardous weather conditions

s 216 amd 2014 SL No. 8 s 69

Using fog lights

s 217 amd 2014 SL No. 8 s 70

Using lights on vehicles that are stopped

s 220 amd 2014 SL No. 8 s 71

Using hazard warning lights

s 221 amd 2010 SL No. 295 s 11

School bus not to be driven without warning lights and warning signs

s 222 amd 2014 SL No. 8 s 72

Use of warning lights—picking up or setting down school children

s 222A amd 2014 SL No. 8 s 73

Using horns and similar warning devices

s 224 amd 2010 SL No. 295 s 12

Using portable warning triangles

s 227 amd 2013 SL No. 192 s 30; 2014 SL No. 279 s 21

Crossing a road at traffic lights

s 232 amd 2013 SL No. 192 s 31

Endnotes

Pedestrians travelling along a road (except if using a wheeled recreational device, wheeled toy or personal mobility device)

prov hdg amd 2013 SL No. 150 s 12(1)
s 238 amd 2013 SL No. 150 s 12(2); 2014 SL No. 279 s 22

Pedestrians on a bicycle path or separated footpath

s 239 amd 2013 SL No. 150 s 13

Travelling in or on a wheeled recreational device or toy on a footpath or shared path

s 242 amd 2013 SL No. 150 s 14

Wearing of helmets by users of motorised scooters

s 244B amd 2013 SL No. 150 s 15

Division 3—Additional rules for using personal mobility devices

div hdg ins 2013 SL No. 150 s 16

Application of pt 14, div 3

s 244C sub 2013 SL No. 150 s 16

Age restrictions for PMD user

s 244D ins 2013 SL No. 150 s 16

Speed limit for device

s 244E ins 2013 SL No. 150 s 16

PMD user to wear helmet

s 244F ins 2013 SL No. 150 s 16

PMD user travelling along a road

s 244G ins 2013 SL No. 150 s 16

No personal mobility devices sign

s 244H ins 2013 SL No. 150 s 16

Using a device on a footpath or shared path

s 244I ins 2013 SL No. 150 s 16

Carrying people on device

s 244J ins 2013 SL No. 150 s 16

Travelling to the left of oncoming PMD users or riders on a path

s 244K ins 2013 SL No. 150 s 16

Warning equipment on device

s 244L ins 2013 SL No. 150 s 16

Using device at night

s 244M ins 2013 SL No. 150 s 16

Bicycle crossing lights provisions also apply to PMD user

s 244N ins 2013 SL No. 150 s 16

Using mobile phones on device

s 244O ins 2013 SL No. 150 s 16

Drinking liquor while using device

s 244P ins 2013 SL No. 150 s 16

Riding in a bicycle lane on a road

s 247 om 2014 SL No. 279 s 23

Entering a bicycle storage area

s 247A om 2014 SL No. 279 s 23

Riding across a road on particular crossings

prov hdg amd 2013 SL No. 192 s 32(1)

s 248 amd 2013 SL No. 192 s 32(2)

sub 2014 SL No. 279 s 24

Riding on a footpath or shared path

s 250 amd 2013 SL No. 150 s 17

Riding to the left of oncoming bicycle riders or device users on a path

prov hdg amd 2013 SL No. 150 s 18(1)

s 251 amd 2013 SL No. 150 s 18(2)

Bicycle helmets

s 256 amd 2013 SL No. 150 s 19

Riding with a person on a bicycle trailer

s 257 amd 2010 SL No. 65 s 3; 2013 SL No. 150 s 20

Riding at night

s 259 amd 2013 SL No. 150 s 21

Stopping for a red bicycle crossing light

s 260 sub 2014 SL No. 279 s 25

Stopping for a yellow bicycle crossing light

s 261 sub 2014 SL No. 279 s 25

Proceeding when bicycle crossing lights change to yellow or red

s 262 amd 2013 SL No. 192 s 33

Wearing of seatbelts by drivers

s 264 amd 2013 SL No. 192 s 34

Wearing of seatbelts by passengers 16 years old or older

s 265 amd 2013 SL No. 192 s 35; 2014 SL No. 279 s 26

Wearing of seatbelts by passengers under 16 years old

s 266 amd 2010 SL No. 65 s 4; 2013 SL No. 42 s 5; 2013 SL No. 192 s 36; 2014 SL No. 279 s 27

Exemptions from wearing seatbelts

s 267 amd 2010 SL No. 65 s 5; 2013 SL No. 42 s 6; 2013 SL No. 192 s 37; 2014 SL No. 279 s 28

How persons must travel in or on a motor vehicle

s 268 amd 2013 SL No. 192 s 38

Endnotes

Wearing motorbike helmets

s 270 amd 2013 SL No. 192 s 39

Duties of a driver involved in a crash

s 287 amd 2014 SL No. 219 s 54

Driving on a path

s 288 amd 2011 SL No. 212 s 8

Making unnecessary noise or smoke

s 291 amd 2014 SL No. 161 s 71

Section number not used

s 292 sub 2013 SL No. 192 s 40

Keeping control of a vehicle being towed

s 294 amd 2014 SL No. 8 s 74

Driver to have proper control of a vehicle etc.

s 297 amd 2013 SL No. 192 s 41

Television receivers and visual display units in motor vehicles

s 299 amd 2014 SL No. 279 s 29

Drinking liquor while driving

s 300A sub 2013 SL No. 150 s 22

Brisbane CBD driving restrictions

s 300B om 2013 SL No. 192 s 42

Driver must not damage rail infrastructure or obstruct level crossing

s 300D ins 2012 SL No. 215 s 7

Leading an animal while in or on a vehicle

s 301 prov hdg amd 2013 SL No. 192 s 43

Exemption for police officers and emergency workers on foot

s 308 amd 2013 SL No. 150 s 23

Exemption for police officers using personal mobility devices

s 308A ins 2013 SL No. 150 s 24

Exemption for oversize vehicles

s 311 amd 2014 SL No. 8 s 75

Exemption for tow truck drivers

s 312 amd 2014 SL No. 8 s 76

Exemption for breakdown vehicles

s 313B amd 2013 SL No. 192 s 44

When do traffic control devices comply substantially with this regulation

s 316 amd 2014 SL No. 279 s 30

How separated footpath signs and separated footpath road markings apply

s 336 amd 2013 SL No. 150 s 25

Giving way to pedestrians crossing a road

s 352A ins 2013 SL No. 192 s 45

Prescribed offences for ch 5, pt 7 of the Act

s 353 amd 2010 SL No. 191 s 133 sch 7; 2014 SL No. 219 s 55

Prescribed offences for the Act, s 113A(2)(a) and (b)

s 353AA ins 2014 SL No. 219 s 56

People with disabilities symbols—Act, sch 4, definition *people with disabilities symbol*

s 353A ins 2011 SL No. 8 s 21

Power-assisted bicycles—Act, sch 4, definition *power-assisted bicycle*

s 353B ins 2012 SL No. 250 s 16

PART 23—AMENDMENT OF TRANSPORT OPERATIONS (ROAD USE MANAGEMENT—DRIVER LICENSING) REGULATION 1999

pt 23 (ss 357–358) om R1 (see RA ss 7(1)(k) and 40)

PART 24—AMENDMENT OF STATE PENALTIES ENFORCEMENT REGULATION 2000

pt 24 (ss 359–361) om R1 (see RA ss 7(1)(k) and 40)

PART 25—CONSEQUENTIAL AMENDMENTS OF OTHER REGULATIONS

pt 25 (s 362) om R1 (see RA ss 7(1)(k) and 40)

SCHEDULE 3—OTHER PERMITTED TRAFFIC SIGNS

amd 2011 SL No. 3 s 8; 2013 SL No. 150 s 26; 2013 SL No. 192 s 46

SCHEDULE 5—DICTIONARYdef *alcohol interlock device* om 2010 SL No. 295 s 13def *angle parking* ins 2014 SL No. 279 s 31(2)def *approved bicycle helmet* amd 2013 SL No. 192 s 47(3)def *approved seatbelt* ins 2013 SL No. 192 s 47(2)def *AS/NZS* ins 2013 SL No. 192 s 47(2)def *bailiff* ins 2014 SL No. 279 s 31(2)def *bicycle crossing* ins 2013 SL No. 192 s 47(2)

amd 2014 SL No. 161 s 72(2)

def *bicycle storage area* amd 2013 SL No. 192 s 47(4)def *bicycle trailer* ins 2014 SL No. 26 s 13def *crossing* amd 2013 SL No. 192 s 47(5)–(6)def *deputy sheriff* ins 2014 SL No. 279 s 31(2)def *detained person* ins 2014 SL No. 279 s 31(2)def *detention vehicle* ins 2014 SL No. 279 s 31(2)def *do not overtake turning vehicle sign* sub 2013 SL No. 192 s 47(1)–(2)def *emergency worker* amd 2014 Act No. 17 s 184 sch 1 pt 2def *give way line* amd 2013 SL No. 192 s 47(7)def *hazard warning lights* sub 2014 SL No. 8 s 77def *heavy vehicle* om 2014 SL No. 8 s 77(1)def *marked foot crossing* amd 2013 SL No. 192 s 47(8); 2014 SL No. 161 s 72(2)def *marked lane* amd 2014 SL No. 161 s 72(2)

Endnotes

- def *mechanical signalling device* sub 2014 SL No. 8 s 77
def *overhead lane control signal* amd 2011 SL No. 3 s 9
def *passenger transport standard* sub 2011 SL No. 287 s 13
def *pavement marker* ins 2014 SL No. 161 s 72(1)
def *pedestrian* ins 2013 SL No. 150 s 27
def *personal mobility device* ins 2013 SL No. 150 s 27
om 2014 SL No. 219 s 57
def *PMD user* ins 2013 SL No. 150 s 27
def *postal worker* sub 2014 SL No. 279 s 31(1)–(2)
def *relevant detention officer* ins 2014 SL No. 279 s 31(2)
def *road marking* amd 2014 SL No. 161 s 72(3)
def *sheriff* ins 2014 SL No. 279 s 31(2)
def *slip lane* amd 2014 SL No. 279 s 31(3)
def *Standards and Safety Regulation* amd 2013 SL No. 192 s 47(9)
def *stop line* amd 2013 SL No. 192 s 47(10)
def *turning lane* amd 2014 SL No. 279 s 31(4)
def *U-turn traffic lane arrows* ins 2014 SL No. 279 s 31(2)

SCHEDULE 6—CONSEQUENTIAL AMENDMENTS OF OTHER REGULATIONS

om R1 (see RA s 40)

© State of Queensland 2015

Authorised by the Parliamentary Counsel